



DEHDASHT PETROCHEMICAL INDUSTRY COMPANY
DEHDASHT HIGH DENSITY POLYETHYLENE PROJECT



Contract No.: DPIC/98-12	DOCUMENT TITLE: Inspection and Test Procedure for Compressor	POI: IFA	Rev.: D0
	DOCUMENT No: DPIC9812-000-VD-1002-ME-PRC-0065	Sheet 1 of 36	

Inspection and Test Procedure for Compressor

PURCHASER'S COMMENT/APPROVAL STATUS

Purchaser: NARGAN

1	AP: Approved (Released for Manufacturing)	Requisition No.: DPIC98-12-001-000-ME-MR-4150-0001-D1 Item No. (Tag No.): PK-6101
X	AN: Approved With Minor Comments (Fabrication may Proceed)	
3	NF: Approved With Comments (Fabrication not Proceed)	
4	RJ: Rejected	
5	NR: Not be Returned	

Vendor Doc. No.: DPIC9812-000-VD-1002-ME-PRC-0065-D0



Date:	20.11.2021	Signature:	A.AB		
D0	23-Oct-21	IFA	Sakaguchi	kato	M.Malekinia
REV.	DATE ISSUE	Purpose of Issue	PREPARED	CHECKED	APPROVED

This document is the property of DPIC. Any unauthorized attempt to reproduce it, in any form, is strictly prohibited.



DEHDASHT PETROCHEMICAL INDUSTRY COMPANY
DEHDASHT HIGH DENSITY POLYETHYLENE PROJECT



Contract No.: DPIC/98-12

DOCUMENT TITLE: Inspection and Test Procedure for Compressor

POI: IFA

Rev.: D0



DOCUMENT No: DPIC9812-000-VD-1002-ME-PRC-0065

Sheet 2 of 36

TABULATION OF REVISED PAGES

Page	Rev-D0	Rev-D1	Rev-D2	Rev-D3	Rev-D4
1	x				
2	x				
3	x				
4	x				
5	x				
6	x				
7	x				
8	x				
9	x				
10	x				
11	x				
12	x				
13	x				
14	x				
15	x				
16	x				
17	x				
18	x				
19	x				
20	x				
21	x				
22	x				
23	x				
24	x				
25	x				
26	x				
27	x				
28	x				
29	x				
30	x				
31	x				
32	x				
33	x				
34	x				
35	x				

Page	Rev-D0	Rev-D1	Rev-D2	Rev-D3	Rev-D4
36	x				
37					
38					
39					
40					
41					
42					
43					
44					
45					
46					
47					
48					
49					
50					
51					
52					
53					
54					
55					
56					
57					
58					
59					
60					
61					
62					
63					
64					
65					
66					
67					
68					
69					
70					

	DEHDASHT PETROCHEMICAL INDUSTRY COMPANY DEHDASHT HIGH DENSITY POLYETHYLENE PROJECT		
Contract No.: DPIC/98-12	DOCUMENT TITLE: Inspection and Test Procedure for Compressor	POI: IFA	Rev.: D0
	DOCUMENT No: DPIC9812-000-VD-1002-ME-PRC-0065	Sheet 3 of 36	

Screw Rotor Dynamic Balance Test

1. Scope

Rotor dynamic balance test is carried out to check whether the compressor's rotor dynamic balance is within the standard value of the standard "Rotating machines - Balance quality requirement of rigid rotors" (JIS B 0905-1992).

2. Dynamic Balance Test

2.1 Method of Dynamic Balance Test

Rotor dynamic balance is measured at two points on each rotor using a screw rotor balancing machine.

Measuring points (see the figures below)

Male rotor At points A and B

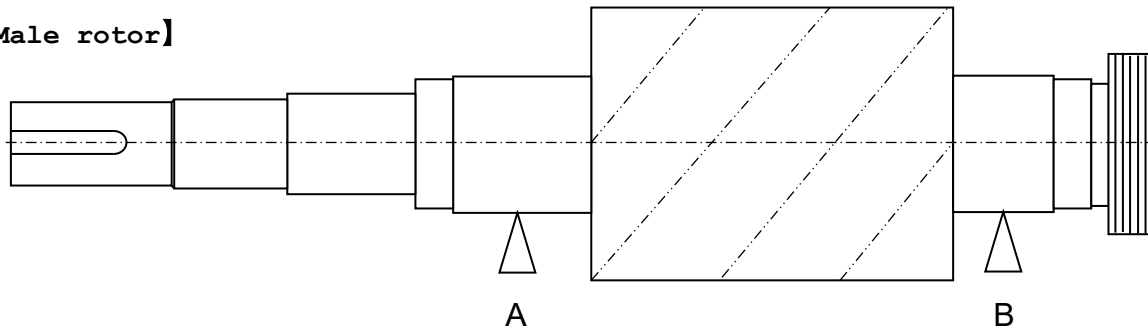

Female rotor At points C and D

[Male rotor]

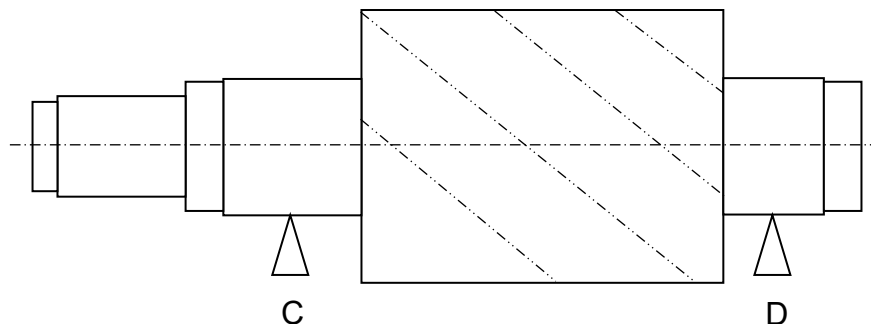

[Female rotor]



	DEHDASHT PETROCHEMICAL INDUSTRY COMPANY DEHDASHT HIGH DENSITY POLYETHYLENE PROJECT		
Contract No.: DPIC/98-12	DOCUMENT TITLE: Inspection and Test Procedure for Compressor	POI: IFA	Rev.: D0
DOCUMENT No: DPIC9812-000-VD-1002-ME-PRC-0065		Sheet 4 of 36	

2.2 Measuring equipment

please check model of compressor and rotoe

Manufacturer	Measuring equipment	Model
NAGAHAMA SEISAKUSHO LTD.,	Dynamic balancing machine	H40U H20NB

please specify equivalent to ISO 1940-1

3. Acceptance Criteria

The acceptance criteria is as per **JIS B 0905 Class G2.5 or Class 1.0** and the measured values must not exceed these criteria. Refer to the following tables as the standard ~~... from rotor materials.~~

please specify ASTM no.

Rotor Material	<input type="checkbox"/> FCD600	<input checked="" type="checkbox"/> SFCM930S	<input type="checkbox"/> SFCM740S
Balance class	<input checked="" type="checkbox"/> Class G2.5		<input type="checkbox"/> Class G1.0

~~3.1.1 JIS G5502 : FCD600 (Ductile Iron) JIS B 0905 Class G2.5 <Single stage compressor>~~

as per bid stage agreement, forged rotor shall be used, there for this clause is N/A

Model					Test Speed (rpm)
	Male rotor		Female rotor		---
	g	g*cm	g	g*cm	
125S	0.7	4.6	0.6	3.5	1265
125L	0.9	6.0	0.7	4.6	1265
160S	1.2	9.5	0.9	7.4	1265
160M	1.3	11.0	1.0	8.6	1265
160L	1.5	12.5	1.2	9.8	1265
160WS	1.2	9.7	0.9	7.5	1265
160WM	1.4	11.1	1.1	8.7	1265
160WL	1.5	12.6	1.2	9.9	1265
200S	1.7	17.8	1.4	13.8	1265
200M	2.0	20.7	1.6	16.2	1265

Continued on the following page



DEHDASHT PETROCHEMICAL INDUSTRY COMPANY
DEHDASHT HIGH DENSITY POLYETHYLENE PROJECT



Contract No.: DPIC/98-12	DOCUMENT TITLE: Inspection and Test Procedure for Compressor	POI: IFA	Rev.: D0
	DOCUMENT No: DPIC9812-000-VD-1002-ME-PRC-0065	Sheet 5 of 36	

200L	2.3	23.5	1.8	18.5	1265
200WS	1.8	18.1	1.4	14.0	1265
200WM	2.1	21.0	1.6	16.3	1265
200WL	2.3	23.8	1.8	18.6	1265
250S	2.6	33.5	2.1	26.4	750
250M	3.1	39.3	2.4	31.1	750
250L	3.5	44.7	2.8	35.6	750
250LL	4.1	51.8	3.3	41.9	750
250WS	2.7	34.4	2.2	27.7	750
250WM	3.1	40.1	2.5	32.4	750
250WL	3.6	45.6	2.9	36.9	750
320S	4.2	68.1	3.3	53.8	430
320M	4.9	79.3	3.9	62.9	430
320L	5.6	90.4	4.5	71.8	430
320LL	6.5	104.3	5.2	84.2	430
320WS	4.3	69.7	3.5	56.1	430
320WM	5.0	80.9	4.1	65.2	430
320WL	5.7	92.0	4.6	74.2	430
400S	7.1	145.6	5.7	115.5	430
400M	8.3	169.2	6.6	134.6	430
400L	9.4	191.4	7.5	152.6	430

Model	Standard value				Test Speed (rpm)
	Male rotor		Female rotor		
	g	g·cm	g	g·cm	---
170JS	1.2	9.8	0.8	6.0	1265
170JM	1.4	11.4	0.9	7.0	1265
170JL	1.6	13.5	1.2	8.6	1265
220JS	2.1	23.3	1.5	14.6	1265
220JM	2.5	27.6	1.8	17.5	1265
220JL	3.0	32.9	2.2	21.3	1265
280JS	4.5	64.3	3.2	40.2	750
280JM	5.3	75.6	3.9	48.1	750
280JL	6.4	90.2	4.7	58.9	750



DEHDASHT PETROCHEMICAL INDUSTRY COMPANY
DEHDASHT HIGH DENSITY POLYETHYLENE PROJECT





Contract No.: DPIC/98-12	DOCUMENT TITLE: Inspection and Test Procedure for Compressor	POI: IFA	Rev.: D0
	DOCUMENT No: DPIC9812-000-VD-1002-ME-PRC-0065	Sheet 6 of 36	

~~3.1.2 JIS G5502 : FCD600 (Ductile Iron) JIS B 0905 Class G1.0 <Single stage compressor>~~

Model	Standard value				Test Speed (rpm)
	Male rotor		Impeller	or	
	g	g*cm			
160S	0.5	3.8	0.4	2.9	1265
160M	0.5	4.4	0.4	3.4	1265
160L	0.6	5.0	0.5	3.9	1265
160WS	0.5	3.9	0.4	3.0	1265
160WM	0.5	4.5	0.4	3.5	1265
160WL	0.6	5.1	0.5	3.9	1265
200S	0.7	7.1	0.5	5.5	1265
200M	0.8	8.3	0.6	6.5	1265
200L	0.9	9.4	0.7	7.4	1265
200WS	0.7	7.2	0.5	5.6	1265
200WM	0.8	8.4	0.6	6.5	1265
200WL	0.9	9.5	0.7	7.5	1265
250S	1.1	13.4	0.8	10.6	750
250M	1.2	15.7	1.0	12.5	750
250L	1.4	17.9	1.1	14.2	750
250LL	1.6	20.7	1.3	16.7	750
250WS	1.1	13.8	0.9	11.1	750
250WM	1.3	16.1	1.0	13.0	750
250WL	1.4	18.2	1.2	14.7	750
320S	1.7	27.2	1.3	21.5	430
320M	2.0	31.7	1.6	25.1	430
320L	2.3	36.1	1.8	28.7	430
320LL	2.6	41.7	2.1	33.7	430
320WS	1.7	27.9	1.4	22.4	430
320WM	2.0	32.4	1.6	26.1	430
320WL	2.3	36.8	1.8	29.7	430
400S	2.9	58.2	2.3	46.2	430
400M	3.3	67.7	2.6	53.8	430
400L	3.8	76.5	3.0	61.0	430

This document is the property of DPIC. Any unauthorized attempt to reproduce it, in any form, is strictly prohibited.



	DEHDASHT PETROCHEMICAL INDUSTRY COMPANY DEHDASHT HIGH DENSITY POLYETHYLENE PROJECT		
Contract No.: DPIC/98-12	DOCUMENT TITLE: Inspection and Test Procedure for Compressor	POI: IFA	Rev.: D0
	DOCUMENT No: DPIC9812-000-VD-1002-ME-PRC-0065	Sheet 7 of 36	

please specify ASTM No.



3.1.1.3 **JIS G3221 : SFCM930S, SFCM740S (Forged Steel) JIS B 0905 Class G2.5 <Single stage compressor>**

please specify which model will be used

Model	value				Test Speed (rpm)
	Male rotor		Female rotor		
	g	g·cm	g	g·cm	
125S	0.8	5.1	0.6	3.9	1265
125L	1.0	6.7	0.8	5.1	1265
160S	1.3	10.5	1.0	8.1	1265
160M	1.5	12.1	1.2	9.4	1265
160L	1.7	13.7	1.3	10.8	1265
160WS	1.3	10.7	1.0	8.2	1265
160WM	1.5	12.3	1.2	9.5	1265
160WL	1.7	13.9	1.3	10.9	1265
200S	1.9	19.6	1.5	15.2	1265
200M	2.2	22.8	1.8	17.9	1265
200L	2.5	25.9	2.0	20.4	1265
200WS	2.0	20.0	1.5	15.4	1265
200WM	2.3	23.2	1.8	18.0	1265
200WL	2.6	26.3	2.0	20.5	1265
250S	2.9	37.0	2.3	29.2	750
250M	3.4	43.3	2.7	34.3	750
250L	3.9	49.3	3.1	39.2	750
250LL	4.5	57.1	3.6	46.2	750

 	DEHDASHT PETROCHEMICAL INDUSTRY COMPANY DEHDASHT HIGH DENSITY POLYETHYLENE PROJECT	 شرکت صنایع پتروشیمی خلیج فارس Persian Gulf Petrochemical Industries Co PGPIC شرکت صنایع پتروشیمی دهشت (سهامی عام)	
Contract No.: DPIC/98-12	DOCUMENT TITLE: Inspection and Test Procedure for Compressor	POI: IFA	Rev.: D0
	DOCUMENT No: DPIC9812-000-VD-1002-ME-PRC-0065	Sheet 8 of 36	



Model	Standard value				Test Speed (rpm)
	Male rotor		Female rotor		
	g	g*cm	g	g*cm	---
250WS	3.0	37.9	2.4	30.6	750
250WM	3.5	44.3	2.8	35.8	750
250WL	3.9	50.3	3.2	40.6	750
320S	4.7	75.1	3.7	59.3	430
320M	5.4	87.5	4.3	69.3	430
320L	6.2	99.7	4.9	79.2	430
320LL	7.2	115.1	5.8	92.9	430
320WS	4.8	76.9	3.9	61.9	430
320WM	5.6	89.3	4.5	71.9	430
320WL	6.3	101.5	5.1	81.8	430
400S	7.9	160.6	6.2	127.3	430
400M	9.1	186.6	7.3	148.5	430
400L	10.3	211.0	8.3	168.3	430
400LL	11.7	238.6	9.3	190.7	430
400XL	12.8	261.7	10.3	209.5	430
400XXL	14.1	288.0	11.3	230.8	430

	DEHDASHT PETROCHEMICAL INDUSTRY COMPANY DEHDASHT HIGH DENSITY POLYETHYLENE PROJECT		
Contract No.: DPIC/98-12	DOCUMENT TITLE: Inspection and Test Procedure for Compressor	POI: IFA	Rev.: D0
	DOCUMENT No: DPIC9812-000-VD-1002-ME-PRC-0065	Sheet 9 of 36	



please specify which model will be used

3.1.4 ← **JIS G3221 : SFCM930S, SFCM740S (Forged Steel) JIS B 0905 Class G1.0 <Single stage compressor>**

Model	Standard value				Test Speed (rpm)
	Male rotor		Female rotor		
	g	g·cm	g	g·cm	---
160S	0.5	4.2	0.4	3.2	1265
160M	0.6	4.8	0.5	3.8	1265
160L	0.7	5.5	0.5	4.3	1265
160WS	0.5	4.3	0.4	3.3	1265
160WM	0.6	4.9	0.5	3.8	1265
160WL	0.7	5.6	0.5	4.3	1265
200S	0.8	7.8	0.6	6.1	1265
200M	0.9	9.1	0.7	7.1	1265
200L	1.0	10.4	0.8	8.2	1265
200WS	0.8	8.0	0.6	6.2	1265
200WM	0.9	9.3	0.7	7.2	1265
200WL	1.0	10.5	0.8	8.2	1265
250S	1.2	14.8	0.9	11.7	750
250M	1.4	17.3	1.1	13.7	750
250L	1.5	19.7	1.2	15.7	750
250LL	1.8	22.8	1.4	18.5	750

 	DEHDASHT PETROCHEMICAL INDUSTRY COMPANY DEHDASHT HIGH DENSITY POLYETHYLENE PROJECT	 شرکت صنایع پتروشیمی خلیج فارس Persian Gulf Petrochemical Industries Co PGPIC شرکت صنایع پتروشیمی دهشت (سهامی عام)	
Contract No.: DPIC/98-12	DOCUMENT TITLE: Inspection and Test Procedure for Compressor	POI: IFA	Rev.: D0
	DOCUMENT No: DPIC9812-000-VD-1002-ME-PRC-0065	Sheet 10 of 36	

Model	Standard value				Test Speed (rpm)
	Male rotor		Female rotor		
	g	g·cm	g	g·cm	---
250WS	1.2	15.2	1.0	12.2	750
250WM	1.4	17.7	1.1	14.3	750
250WL	1.6	20.1	1.3	16.3	750
320S	1.9	30.0	1.5	23.7	430
320M	2.2	35.0	1.7	27.7	430
320L	2.5	39.9	2.0	31.7	430
320LL	2.9	46.0	2.3	37.2	430
320WS	1.9	30.8	1.5	24.8	430
320WM	2.2	35.7	1.8	28.8	430
320WL	2.5	40.6	2.0	32.7	430
400S	3.1	64.2	2.5	50.9	430
400M	3.7	74.6	2.9	59.4	430
400L	4.1	84.4	3.3	67.3	430
400LL	4.7	95.5	3.7	76.3	430
400XL	5.1	104.7	4.1	83.8	430
400XXL	5.6	115.2	4.5	92.3	430

 	DEHDASHT PETROCHEMICAL INDUSTRY COMPANY DEHDASHT HIGH DENSITY POLYETHYLENE PROJECT		
Contract No.: DPIC/98-12	DOCUMENT TITLE: Inspection and Test Procedure for Compressor	POI: IFA	Rev.: D0
	DOCUMENT No: DPIC9812-000-VD-1002-ME-PRC-0065	Sheet 11 of 36	

~~3.2.1 JIS G5502 : FCD600 (Ductile Iron) JIS B 0905 Class G2.5 <Compound two stage compressor>~~

as per bid stage agreement, forged rotor shall be used, there for this clause is N/A

model			Standard value				Test Speed (rpm)
			Male rotor		Female rotor		
			g	g·cm	g	g·cm	---
1610	low stage	S	1.1	8.7	0.8	6.7	1265
	high stage	L	0.6	3.2	0.5	2.7	1265
1612	low stage *: mounted on speed-up gear	S	1.1	8.9	0.8	6.7	1265
		M	1.3	10.4	1.0	7.9	1265
		L	1.5	11.8	1.1	9.1	1265
		L*	1.5	12.0	1.1	9.1	1265
	high stage	S	0.6	4.0	0.5	3.4	1265
		L	0.9	5.4	0.7	4.5	1265
2016	low stage	S	1.7	17.0	1.3	13.6	1265
		M	2.0	19.9	1.6	16.0	1265
		L	2.2	22.7	1.8	18.3	1265
	high stage	S	1.0	8.4	0.9	7.0	1265
		M	1.2	9.9	1.0	8.2	1265
		L	1.4	11.4	1.1	9.4	1265

Continued on the following page





DEHDASHT PETROCHEMICAL INDUSTRY COMPANY
DEHDASHT HIGH DENSITY POLYETHYLENE PROJECT



Contract No.: DPIC/98-12	DOCUMENT TITLE: Inspection and Test Procedure for Compressor	POI: IFA	Rev.: D0
	DOCUMENT No: DPIC9812-000-VD-1002-ME-PRC-0065	Sheet 12 of 36	

model			Standard value				Test Speed (rpm)
			Male rotor		Female rotor		
			g	g*cm	g	g*cm	---
2520	low stage	S	2.6	32.8	2.1	26.4	750
		M	3.0	38.5	2.4	31.1	750
		L	3.4	44.0	2.8	35.6	750
	high stage	S	1.7	16.9	1.4	13.8	1265
		M	1.9	19.9	1.6	16.2	1265
		L	2.2	22.7	1.8	18.5	1265
3225	low stage	S	4.1	66.3	3.3	53.8	430
		M	4.8	77.5	3.9	62.9	430
		L	5.5	88.6	4.5	71.8	430
		LL	6.3	100.9	5.1	81.9	430
	high stage	S	2.5	31.6	2.0	25.9	750
		WS	2.5	32.5	2.1	27.2	750
		M	2.9	37.4	2.4	30.6	750
		WM	3.0	38.3	2.5	31.9	750
		L	3.4	42.9	2.7	35.0	750
		WL	3.4	43.7	2.8	36.3	750
4032	low stage	S	7.0	142.4	5.7	115.5	430
		M	8.1	166.0	6.6	134.6	430
		L	9.2	188.2	7.5	152.6	430
		LL	10.5	213.2	8.5	172.9	430
		XL	11.5	234.1	9.3	189.9	430
	high stage	S	4.1	65.2	3.3	53.8	430
		WS	4.2	66.9	3.5	56.1	430
		M	4.8	76.4	3.9	62.9	430
		WM	4.9	78.1	4.1	65.2	430
		L	5.4	87.5	4.5	71.8	430
	WL	5.5	89.1	4.6	74.2	430	
	LL	6.3	101.5	5.2	84.2	430	



	DEHDASHT PETROCHEMICAL INDUSTRY COMPANY DEHDASHT HIGH DENSITY POLYETHYLENE PROJECT		
Contract No.: DPIC/98-12	DOCUMENT TITLE: Inspection and Test Procedure for Compressor	POI: IFA	Rev.: D0
	DOCUMENT No: DPIC9812-000-VD-1002-ME-PRC-0065	Sheet 13 of 36	

JIS 3.2.2

~~G5502 : FCD600 (Ductile Iron) JIS B 0905 Class G1.0 <Compound two stage compressor~~

model			Standard value				Test Speed (rpm)
			as per bid stage agreement, forged rotor shall be used, there for this clause is N/A		Female rotor		
		g			g*cm	---	
1610	low stage	S	0.4	3.5	0.3	2.7	1265
1612	low stage *: mounted on speed-up gear	S	0.4	3.6	0.3	2.7	1265
		M	0.5	4.1	0.4	3.1	1265
		L	0.6	4.7	0.4	3.6	1265
		L*	0.6	4.8	0.4	3.6	1265
2016	low stage	S	0.7	6.8	0.5	5.4	1265
		M	0.8	8.0	0.6	6.4	1265
		L	0.9	9.1	0.7	7.3	1265
	high stage	S	0.4	3.4	0.3	2.8	1265
		M	0.5	4.0	0.4	3.3	1265
		L	0.6	4.6	0.5	3.7	1265
2520	low stage	S	1.0	13.1	0.8	10.6	750
		M	1.2	15.4	1.0	12.5	750
		L	1.4	17.6	1.1	14.2	750
	high stage	S	0.7	6.8	0.5	5.5	1265
		M	0.8	7.9	0.6	6.5	1265
		L	0.9	9.1	0.7	7.4	1265
3225	low stage	S	1.7	26.5	1.3	21.5	430
		M	1.9	31.0	1.6	25.1	430
		L	2.2	35.4	1.8	28.7	430
		LL	2.5	40.4	2.0	32.7	430
	high stage	S	1.0	12.7	0.8	10.4	750
		WS	1.0	13.0	0.9	10.9	750
		M	1.2	15.0	1.0	12.2	750
		WM	1.2	15.3	1.0	12.7	750
		L	1.3	17.1	1.1	14.0	750
		WL	1.4	17.5	1.1	14.5	750

Continued on the following page

 	DEHDASHT PETROCHEMICAL INDUSTRY COMPANY DEHDASHT HIGH DENSITY POLYETHYLENE PROJECT		
Contract No.: DPIC/98-12	DOCUMENT TITLE: Inspection and Test Procedure for Compressor	POI: IFA	Rev.: D0
	DOCUMENT No: DPIC9812-000-VD-1002-ME-PRC-0065	Sheet 14 of 36	

model			Standard value				Test Speed (rpm)
			Male rotor		Female rotor		
			g	g*cm	g	g*cm	---
4032	low stage	S	2.8	57.0	2.3	46.2	430
		M	3.3	66.4	2.6	53.8	430
		L	3.7	75.3	3.0	61.0	430
		LL	4.2	85.3	3.4	69.2	430
		XL	4.6	93.7	3.7	76.0	430
	high stage	S	1.6	26.1	1.3	21.5	430
		WS	1.7	26.7	1.4	22.4	430
		M	1.9	30.6	1.6	25.1	430
		WM	1.9	31.2	1.6	26.1	430
		L	2.2	35.0	1.8	28.7	430
		WL	2.2	35.6	1.8	29.7	430
		LL	2.5	40.6	2.1	33.7	430



DEHDASHT PETROCHEMICAL INDUSTRY COMPANY
DEHDASHT HIGH DENSITY POLYETHYLENE PROJECT



Contract No.: DPIC/98-12	DOCUMENT TITLE: Inspection and Test Procedure for Compressor	POI: IFA	Rev.: D0
	DOCUMENT No: DPIC9812-000-VD-1002-ME-PRC-0065	Sheet 16 of 36	

model			Standard value				Test Speed (rpm)
			Male rotor		Female rotor		
			g	g*cm	g	g*cm	
2520	low stage	S	2.8	36.1	2.3	29.2	750
		M	3.3	42.5	2.7	34.3	750
		L	3.8	48.5	3.1	39.2	750
	high stage	S	1.8	18.7	1.5	15.2	1265
		M	2.1	21.9	1.8	17.9	1265
		L	2.5	25.0	2.0	20.4	1265
3225	low stage	S	4.6	73.2	3.7	59.3	430
		M	5.3	85.5	4.3	69.3	430
		L	6.1	97.7	4.9	79.2	430
		LL	6.9	111.3	5.6	90.3	430
	high stage	S	2.7	34.9	2.2	28.6	750
		WS	2.8	35.8	2.3	30.0	750
		M	3.2	41.3	2.6	33.8	750
		WM	3.3	42.2	2.8	35.1	750
		L	3.7	47.3	3.0	38.7	750
		WL	3.8	48.2	3.1	40.0	750
4032	low stage	S	7.7	157.1	6.2	127.3	430
		M	9.0	183.1	7.3	148.5	430
		L	10.2	207.5	8.3	168.3	430
		LL	11.5	235.1	9.3	190.7	430
		XL	12.7	258.2	10.3	209.5	430
	high stage	S	4.5	71.9	3.7	59.3	430
		WS	4.6	73.7	3.9	61.9	430
		M	5.2	84.3	4.3	69.3	430
		WM	5.4	86.1	4.5	71.9	430
		L	6.0	96.5	4.9	79.2	430
		WL	6.1	98.3	5.1	81.8	430
		LL	7.0	111.9	5.8	92.9	430



DEHDASHT PETROCHEMICAL INDUSTRY COMPANY
DEHDASHT HIGH DENSITY POLYETHYLENE PROJECT



Contract No.: DPIC/98-12	DOCUMENT TITLE: Inspection and Test Procedure for Compressor	POI: IFA	Rev.: D0
	DOCUMENT No: DPIC9812-000-VD-1002-ME-PRC-0065	Sheet 17 of 36	

please specify which model will be used

JIS G3221 : 3.2.4



<SFCM930S,SFCM740S (Forged Steel) JIS B 0905 Class G1.0 <Compound two-stage compressor

please specify ASTM No.

model			Standard value				Test Speed (rpm)
			Male rotor		Female rotor		
			g	g*cm	g	g*cm	
1610	low stage	S	0.5	3.8	0.4	2.9	1265
1612	low stage	S	0.5	3.9	0.4	2.9	1265
		M	0.6	4.6	0.4	3.5	1265
		L	0.6	5.2	0.5	4.0	1265
		L*	0.7	5.3	0.5	4.0	1265
2016	low stage	S	0.7	7.5	0.6	6.0	1265
		M	0.9	8.8	0.7	7.0	1265
		L	1.0	10.0	0.8	8.1	1265
	high stage	S	0.5	3.7	0.4	3.1	1265
		M	0.5	4.4	0.4	3.6	1265
		L	0.6	5.0	0.5	4.1	1265
2520	low stage	S	1.1	14.5	0.9	11.7	750
		M	1.3	17.0	1.1	13.7	750
		L	1.5	19.4	1.2	15.7	750
	high stage	S	0.7	7.5	0.6	6.1	1265
		M	0.9	8.8	0.7	7.1	1265
		L	1.0	10.0	0.8	8.2	1265
3225	low stage	S	1.8	29.3	1.5	23.7	430
		M	2.1	34.2	1.7	27.7	430
		L	2.4	39.1	2.0	31.7	430
		LL	2.8	44.5	2.2	36.1	430
	high stage	S	1.1	14.0	0.9	11.4	750
		WS	1.1	14.3	0.9	12.0	750
		M	1.3	16.5	1.1	13.5	750
		WM	1.3	16.9	1.1	14.1	750
		L	1.5	18.9	1.2	15.5	750
		WL	1.5	19.3	1.3	16.0	750

This document is the property of DPIC. Any unauthorized attempt to reproduce it, in any form, is strictly prohibited.

Continued on the following page

 	DEHDASHT PETROCHEMICAL INDUSTRY COMPANY DEHDASHT HIGH DENSITY POLYETHYLENE PROJECT		
Contract No.: DPIC/98-12	DOCUMENT TITLE: Inspection and Test Procedure for Compressor	POI: IFA	Rev.: D0
	DOCUMENT No: DPIC9812-000-VD-1002-ME-PRC-0065	Sheet 18 of 36	

model			Standard value				Test Speed (rpm)
			Male rotor		Female rotor		
			g	g*cm	g	g*cm	---
4032	low stage	S	3.1	62.8	2.5	50.9	430
		M	3.6	73.2	2.9	59.4	430
		L	4.1	83.0	3.3	67.3	430
		LL	4.6	94.1	3.7	76.3	430
		XL	5.1	103.3	4.1	83.8	430
	high stage	S	1.8	28.8	1.5	23.7	430
		WS	1.8	29.5	1.5	24.8	430
		M	2.1	33.7	1.7	27.7	430
		WM	2.1	34.4	1.8	28.8	430
		L	2.4	38.6	2.0	31.7	430
		WL	2.4	39.3	2.0	32.7	430
		LL	2.8	44.8	2.3	37.2	430

4. Records

The test results and judgment are recorded on Appendix-1: MALE/FEMALE ROTOR BALANCING TEST REPORT.



DEHDASHT PETROCHEMICAL INDUSTRY COMPANY
DEHDASHT HIGH DENSITY POLYETHYLENE PROJECT



Contract No.: DPIC/98-12

DOCUMENT TITLE: Inspection and Test Procedure for Compressor

POI: IFA

Rev.: D0

DOCUMENT No: DPIC9812-000-VD-1002-ME-PRC-0065

Sheet 19 of 36

Appendix-1 SAMPLE



Item No. -

Report No. 0
Serial No. 0

Rotor Balancing Test Report

Model No.	Material	Test Speed	Correction Radius
0	0	0	0

$$\text{Allowable Residual Unbalance value} = \frac{0 \times 9550}{3600} \times \frac{M}{2} \times \frac{1}{10} \quad \text{Class: G 0} \quad \text{(ISO B 0905)}$$

Rotor Weight (M) : 0 Test Rig Drive : NISHAHAMA-SCHENCK
Female Rotor Height (H) : Model : 100

Sample

MALE ROTOR

Rotor No.	Date
0	January 0, 1900

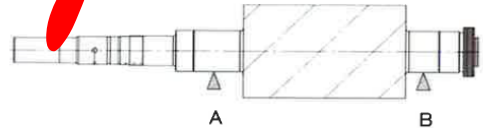

	Unbalanced Value at the Left Side (A)			Unbalanced Value at the Right Side (B)		
	(g)	Angle (°)	Value(g.cm)	(g)	Angle (°)	Value(g.cm)
Allowable Residual Unbalance	---	---	0	---	---	0
Before Adjustment	0.000	0	0.0	0.000	0	0.0
After Adjustment	---	---	---	---	---	---

FEMALE ROTOR

Rotor No.	Date
0	January 0, 1900

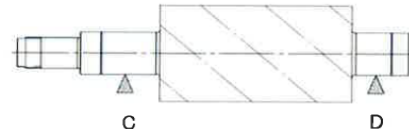



	Unbalanced Value at the Left Side (C)			Unbalanced Value at the Right Side (D)		
	(g)	Angle (°)	Value(g.cm)	(g)	Angle (°)	Value(g.cm)
Allowable Residual Unbalance	---	---	0	---	---	0
Before Adjustment	0.000	0	0.0	0.000	0	0.0
After Adjustment	---	---	---	---	---	---

Criteria Judgment : Accepted

SURVEYOR

Checked by : _____

Approved by : _____

	DEHDASHT PETROCHEMICAL INDUSTRY COMPANY DEHDASHT HIGH DENSITY POLYETHYLENE PROJECT		
Contract No.: DPIC/98-12	DOCUMENT TITLE: Inspection and Test Procedure for Compressor	POI: IFA	Rev.: D0
	DOCUMENT No: DPIC9812-000-VD-1002-ME-PRC-0065	Sheet 20 of 36	

Screw Compressor Standard Inspection Procedures Hydrostatic Test

Hydrostatic Test

1. Scope

This procedure defines the hydrostatic test performed at Moriya Plant, by the Compressor Manufacturing Division.

2. Hydrostatic test

2.1 Test Procedure

After assembling the compressor, it is filled with refrigeration oil.

The hydrostatic test is performed under the conditions shown in Table-1 for 30 minutes.

Table-1

Design pressure	2.6MPaG
Test pressure	3.9MPaG

Note: Two pressure gauges are used.

The test pressure is 1.5 times the design pressure.

The fluid used for the hydrostatic test is lubrication oil VG32 as standard.

3. Acceptance Criteria

The acceptance criterion is a visual inspection to ensure there are no distortions and leakages.

4. Records

The test results are recorded in Appendix-1:Hydrostatic & Pneumatic Tests Report.



DEHDASHT PETROCHEMICAL INDUSTRY COMPANY
DEHDASHT HIGH DENSITY POLYETHYLENE PROJECT



Contract No.: DPIC/98-12

DOCUMENT TITLE: Inspection and Test Procedure for Compressor

POI: IFA

Rev.: D0

DOCUMENT No: DPIC9812-000-VD-1002-ME-PRC-0065

Sheet 21 of 36

[Appendix]-1

SAMPLE

Hydrostatic &
Pneumatic Tests
Report



Report No. 0

Hydrostatic & Pneumatic Tests Report

Name of Client	
Type of Compressor	Screw Compressor
Compressor Model No.	0
Compressor Serial No.	0

TEST RECORD

Item	Design Pressure MPaG	Test Pressure MPaG	Used Fluid	Hold Time(Min)	Tested Date	Judgment
Hydrostatic test	2.6	3.9	OIL	30	March 13, 2012	Accepted
Pneumatic Pressure test	2.6	2.6	Air	30	December 31, 2012	Accepted

USED PRESSURE GAUGES

Item	Dia × Max. Pres. MPa.G	Manufacturer	Class(JIS)	No.
Hydrostatic test	φ 100 × 5.0	NAGANO	1.5	1, 2
Pneumatic Pressure test	φ 100 × 3.5	NAGANO	1.5	3, 4

Note :

MYCOM Control No.

AA-5.0100

AA-5.0103



3, AA-3.5001

4, AA-3.5002

SURVEYOR

Checked by : _____

Approved by : _____

	DEHDASHT PETROCHEMICAL INDUSTRY COMPANY DEHDASHT HIGH DENSITY POLYETHYLENE PROJECT		
Contract No.: DPIC/98-12	DOCUMENT TITLE: Inspection and Test Procedure for Compressor	POI: IFA	Rev.: D0
	DOCUMENT No: DPIC9812-000-VD-1002-ME-PRC-0065	Sheet 22 of 36	

Screw Compressor Standard Inspection Procedures Gas Leak Test

Gas Leak Test

1. Scope

This procedure defines the gas leak test performed at Moriya Plant, by the Compressor Manufacturing Division.

2. Gas Leak Test

2.1 Test procedure

The gas leak test should be performed after the hydrostatic test.

The gas leak test is performed under the conditions shown in Table-1 by submerging the compressor under water for 30 minutes.

Table-1

Design pressure	2.6MPaG
Test pressure	2.6MPaG

Note: Two pressure gauges are used.

The test pressure is the same as the design pressure.

The gas used for the gas leak test is dry air as standard.

3. Acceptance Criteria

The acceptance criterion is a visual inspection to ensure no air bubbles are evident.

4. Records

The test results are recorded in Appendix-1:Hydrostatic & Gas Leak Tests Report.



DEHDASHT PETROCHEMICAL INDUSTRY COMPANY
DEHDASHT HIGH DENSITY POLYETHYLENE PROJECT



Contract No.: DPIC/98-12

DOCUMENT TITLE: Inspection and Test Procedure for Compressor

POI: IFA

Rev.: D0

DOCUMENT No: DPIC9812-000-VD-1002-ME-PRC-0065

Sheet 23 of 36

MYCOM

SAMPLE

Appendix-1:
Hydrostatic &
Gas Leak Tests
Report

Report No. 0

Hydrostatic & Gas Leak Test Report

Item No.	-
Type of Compressor	Screw Compressor
Compressor Model No.	0
Compressor Serial No.	0

TEST RECORD

Item	Design Pressure MPaG	Test Pressure MPaG	Used Fluid	Hold Time(Min)	Tested Date	Judgment
Hydrostatic test	2.6	3.9	OIL	30		Accepted
Gas Leak test	2.6	2.6	Air	30		Accepted

USED PRESSURE GAUGES

Item	Dia × Max. Pres. MPa.G	Manufacturer	Class(JIS)	No.
Hydrostatic test	φ 100 × 7.0	NAGANO	1.5	1, 2
Gas Leak test	φ 100 × 5.0	NAGANO	1.5	3, 4



Note :

No.	Registration No.	Terms of validity
1	AA-70105	Feb,2017
2	AA-70107	Feb,2017
3	AA-50005	Oct,2016
4	AA-50006	Oct,2016

SURVEYOR

Checked by : _____

Approved by : _____

	DEHDASHT PETROCHEMICAL INDUSTRY COMPANY DEHDASHT HIGH DENSITY POLYETHYLENE PROJECT		
Contract No.: DPIC/98-12	DOCUMENT TITLE: Inspection and Test Procedure for Compressor	POI: IFA	Rev.: D0
	DOCUMENT No: DPIC9812-000-VD-1002-ME-PRC-0065	Sheet 24 of 36	

Screw Compressor Standard Inspection Procedures

Performance Test, Mechanical Running Test, Noise and Vibration Test



1. Scope

These procedures apply to the performance test, mechanical running test, vibration and noise tests of MYCOM screw compressors at the compressor manufacturing division of Mayekawa's Moriya plant, using air test equipment. The test fluid should be air. For equipment required for these tests such as couplings, motors, oil separators, cooler and measurement equipment, the test benches at the plant are used.

please specify which model will be used

2. Applicable Models

	Model	Type	Manufacture d from	Remarks
1	UD/G series	125*U*/*G 320*U*/*U	~ 1970	Single stage compressor (side discharge, downward discharge)
2	SCV series	160V**~250V**	1991	Single stage compressor (side discharge, downward discharge)
3	SCV series	320V**	1998	Single stage compressor (side discharge, downward discharge)
4	VR series	160V*R	1996	Single stage compressor (with gear box)
5	Compound type two-stage compressor series	1610**C~3225**C	1975	
6	Compound type two-stage compressor series	4032**C	2001	
7	UD series	400*UD	2002	Single stage compressor (side discharge)
8	J series	170*J, 220J*, 280J*	2011	Single stage compressor

	DEHDASHT PETROCHEMICAL INDUSTRY COMPANY DEHDASHT HIGH DENSITY POLYETHYLENE PROJECT		
Contract No.: DPIC/98-12	DOCUMENT TITLE: Inspection and Test Procedure for Compressor	POI: IFA	Rev.: D0
	DOCUMENT No: DPIC9812-000-VD-1002-ME-PRC-0065	Sheet 25 of 36	

3. Tests

- 1) Performance test
 - capacity
 - brake horse power
- 2) Mechanical running test
- 3) Vibration and noise tests

4. Performance Test

[Capacity]

4.1 Purpose

This test is carried out to determine that the volume flow rate of suction gas at the inlet of the compressor and the brake horse power.

Please specify method for conversion of capacity, power, pressure and temperature will be done as per which code

4.2 Measuring Method/Equipment and Test Conditions

In accordance with the JIS standard *Measurement of Fluid Flow by means of Orifice Plates, Nozzles And Venturi Tubes* (JIS Z 8762:2007), we measure pressures and temperatures required for calculating the volume rate of flows from ① to ⑬ shown in the Figure-1: Test Equipment and Measurement Points using pressure gauge, manometer and thermometers. Performance measurement will be done during the mechanical running test.

The test fluid used for performance test and mechanical running test should be air. Testing is conducted under standard testing conditions (refer to Table-1). Motor revolution is controlled by 2950-3000 rpm (2P) or 1450-1500rpm (4P). Gears and the like are not used to increase the speed of the compressor. The load operating conditions should be 100%, that is, the slide valve opening should be 100%.

The standard temperature of compressor lubrication oil should be 30°C to 50°C. The standard pressure of compressor lubrication oil on the discharge side is 0.2 to 0.3MPaG higher than the discharge pressure. When discharge pressure is 0.7 MPaG, then (with a tolerance of between 0.2 to 0.3) the standard pressure should be 0.9 to 1.0 MPaG.

Measurement equipment differs according to the test bench required for each compressor type. Refer to Appendix Table-2: Measurement Equipment List for details as reference.



DEHDASHT PETROCHEMICAL INDUSTRY COMPANY
DEHDASHT HIGH DENSITY POLYETHYLENE PROJECT



Contract No.: DPIC/98-12	DOCUMENT TITLE: Inspection and Test Procedure for Compressor	POI: IFA	Rev.: D0
	DOCUMENT No: DPIC9812-000-VD-1002-ME-PRC-0065	Sheet 26 of 36	

Figure-1 : Test Equipment and Measurement Points

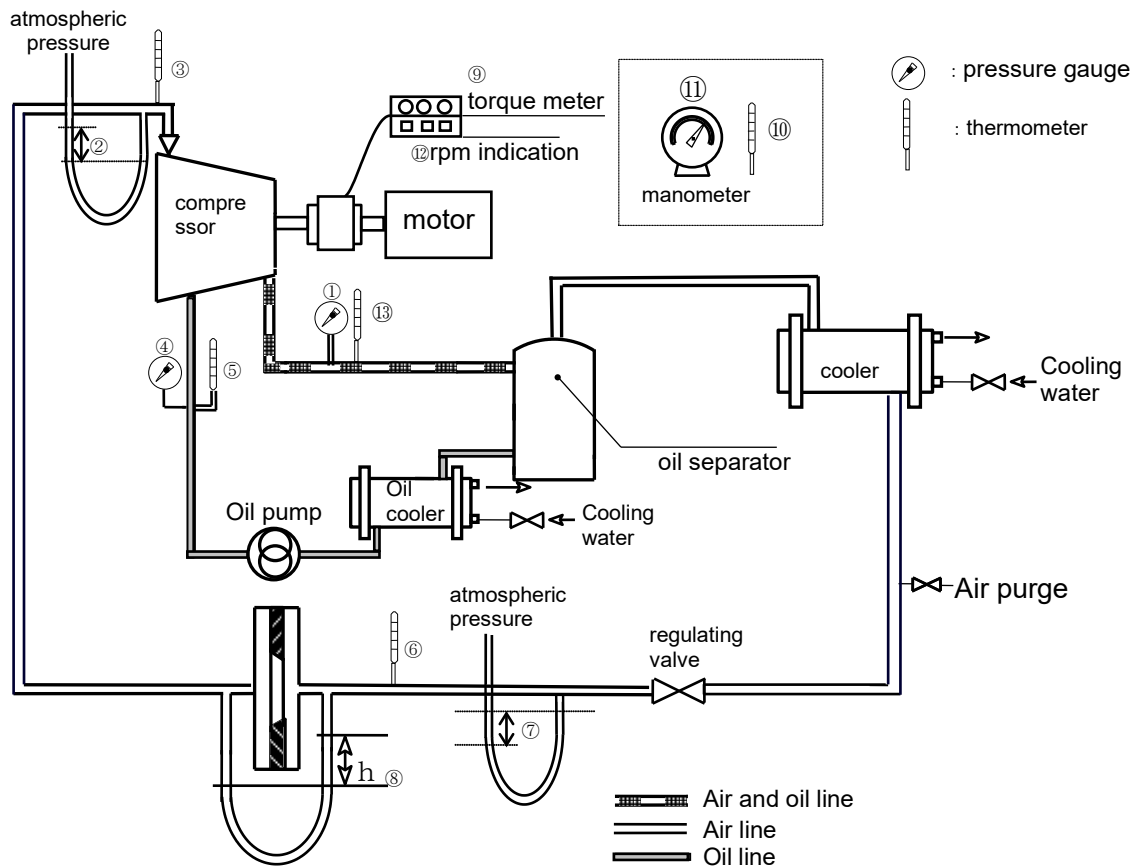

① : Discharge pressure	(MPaG)	⑧ : Orifice differential pressure	(kPa)
② : Suction pressure	(kPaG)	⑨ : Torque	(Nm)
③ : Suction temperature	(°C)	⑩ : Room temperature	(°C)
④ : Lubrication oil supply pressure	(MPaG)	⑪ : Atmospheric pressure	(hPa)
⑤ : Lubrication oil temperature	(°C)	⑫ : Motor revolution	(min ⁻¹)
⑥ : Temperature before orifice	(°C)	⑬ : Discharge temperature	(°C)
⑦ : Pressure before orifice	(kPaG)		

In addition intermediate temperature and intermediate pressure are measured for compound type compressors.



DEHDASHT PETROCHEMICAL INDUSTRY COMPANY
DEHDASHT HIGH DENSITY POLYETHYLENE PROJECT



Contract No.: DPIC/98-12	DOCUMENT TITLE: Inspection and Test Procedure for Compressor	POI: IFA	Rev.: D0
	DOCUMENT No: DPIC9812-000-VD-1002-ME-PRC-0065	Sheet 27 of 36	

Unit : MPaG

Code	Classification	Suction pressure	Discharge pressure
F	Single stage type	V i : 1.8	0. 0 0
J		V i : 2.0	0. 0 0
K		V i : 2.2	0. 0 0
L		V i : 2.6	0. 0 0
M		V i : 3.6	0. 0 0
H		V i : 5.8	0. 0 0
C	Compound type	0. 0 0	0. 7 0
B	Booster type	0. 0 0	0. 3 0
DD	Slide Valve with groove	0. 0 0	0. 3 0

Note) Vi : design volume ratio



[Table-1:Standard pressure conditions]

4.3. Calculation of the Volume Flow Rate of Suction Gas

Calculate the volume ratio of suction gas flow before orifice (Qa) from formula (1) below using orifice differential pressure, pressure before orifice and temperature.

$$Q_a = \varepsilon \cdot \alpha \cdot \pi / 4 (dt \times 10^{-3})^2 \sqrt{2 \cdot \Delta H} \times 10^6 \times V_O \times 3600 \cdot \cdot (1)$$

Qa	the volume flow rate of suction gas before orifice	(m ³ /h)
ε	expansibility factor	(—)
α	flow coefficient	(—)
dt	Diameter of orifice	(mm)
ΔH	Differential pressure around orifice plate	(MPa)
Vo	Gas specific volume before orifice	(m ³ /kg)

	DEHDASHT PETROCHEMICAL INDUSTRY COMPANY DEHDASHT HIGH DENSITY POLYETHYLENE PROJECT		
Contract No.: DPIC/98-12	DOCUMENT TITLE: Inspection and Test Procedure for Compressor	POI: IFA	Rev.: D0
	DOCUMENT No: DPIC9812-000-VD-1002-ME-PRC-0065	Sheet 28 of 36	

Calculate the volume ratio of flow of suction gas at compressor inlet (Qs) from formula (2) using gas volume ratio before the orifice and at the suction inlet.

$$Q_s = Q_a \times \frac{V_S}{V_O} \dots \dots (2)$$

Qs	the volume flow rate of suction gas at the compressor inlet	(m ³ /h)
Qa	the volume flow rate of suction gas before orifice	(m ³ /h)
VS	Gas specific volume at compressor inlet	(m ³ /kg)
VO	Gas specific volume before orifice	(m ³ /kg)

please specify design code for acceptance criteria

4.3.1 Acceptance Criteria

The volume rate flow of suction gas calculated from the actual values should be acceptable if it is over 95% of the standard volume flow rate of suction gas. The standard volume flow rate of suction gas is calculated by the approximate expression that has been developed based on the test results of numerous compressors over many years.

4.3.2 Records

The test results are recorded in Appendix-1: Screw Compressor Test Records.

[Break Horse Power]

4.4 Measuring Break Horse Power

4.4.1 Purpose

Torque and motor revolutions are measured to calculate the break horse power.

4.4.2. Measurement Method/Equipment and Conditions

Measurement conditions are the same as for the capacity test.



Torque is measured using the torque meter mounted on the rotational axis.

Motor revolutions are measured using a tachometer.

4.4.3. Break horse power is calculated from the formula (3) below using the reading value of the torque meter.

$$kW = \frac{1}{1000} \times \frac{2\pi}{60} \times \text{RPM} \times \text{TRQ} \dots \dots (3)$$

kW	break horse power	(kW)
RPM	motor revolution	(min ⁻¹)
TRQ	torque	(Nm)

	DEHDASHT PETROCHEMICAL INDUSTRY COMPANY DEHDASHT HIGH DENSITY POLYETHYLENE PROJECT		
Contract No.: DPIC/98-12	DOCUMENT TITLE: Inspection and Test Procedure for Compressor	POI: IFA	Rev.: D0
	DOCUMENT No: DPIC9812-000-VD-1002-ME-PRC-0065	Sheet 29 of 36	

4.4.4. Acceptance Criteria

104%

If the break horse power from above is less than 105% of the standard power value, it should be acceptable. The standard power value is calculated by the approximate expression which has been developed based on the test results of numerous compressors for many years.

4.4.5. Records

The test results are recorded in Appendix-1: Screw Compressor Test Records.

5. Mechanical Running Test

four hours

5.1 Purpose

After compressor operation stabilizes*, perform a two hour running test to check for faults by measuring the surface temperature of the compressor.

*Stable operation state means the change of lubrication oil temperature is within 3 degrees in 30minutes while meeting the test conditions stipulated in paragraph 4.2 and Table-1, 30minutes after start-up.

5.2 Measurement Method/Equipment and Conditions

In 30minutes after start-up when the compressor operation reaches stable state while maintaining the test conditions stipulated in paragraph 4.2 and Table-1, measure the surface temperature at each point shown in Figure-2 and Figure-3 and check the lubrication, vibration, noise and for other abnormalities.

The surface temperature measurement locations are shown in Figures 2 and 3.

Figure 2: Single Stage Compressor

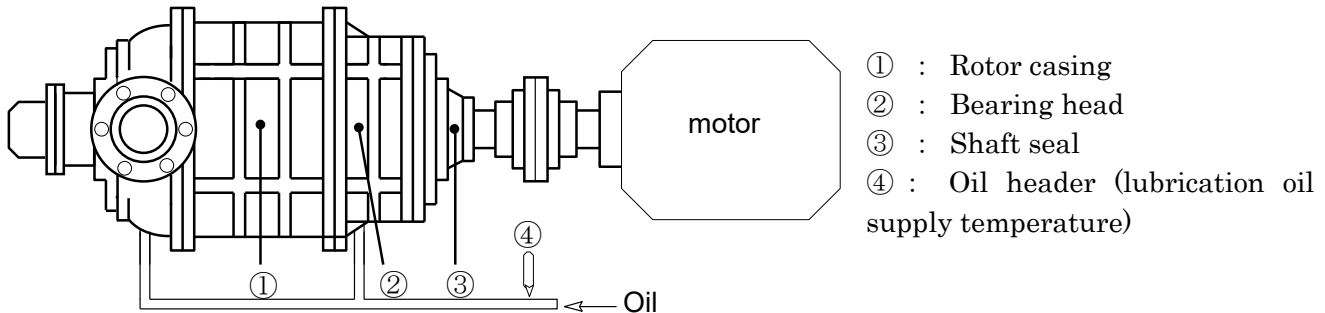



	DEHDASHT PETROCHEMICAL INDUSTRY COMPANY DEHDASHT HIGH DENSITY POLYETHYLENE PROJECT		
Contract No.: DPIC/98-12	DOCUMENT TITLE: Inspection and Test Procedure for Compressor	POI: IFA	Rev.: D0
	DOCUMENT No: DPIC9812-000-VD-1002-ME-PRC-0065	Sheet 30 of 36	

Figure 3: Compound Type Compressor



5.3 Acceptance Criteria

Measurement values that do not exceed the values indicated in Table-2 are accepted.

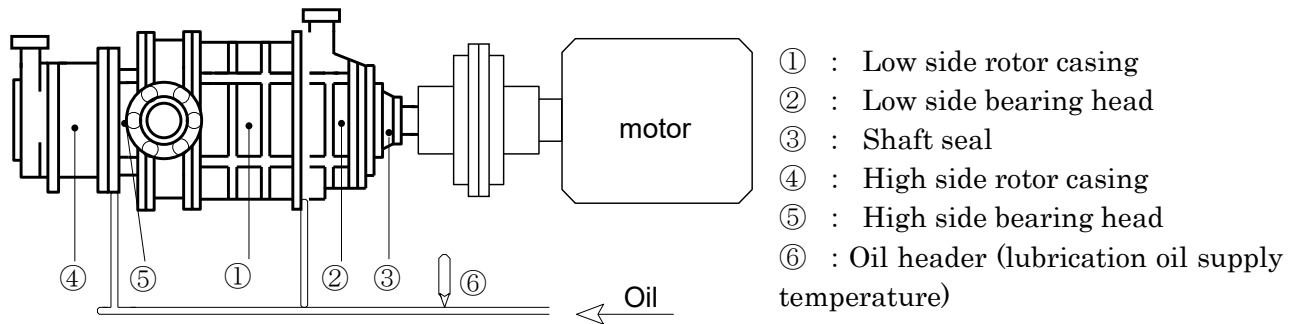
Single stage compressor	Compound type two stage compressor	Allowable value
① Rotor casing	① Low side rotor casing	Lubrication oil temperature +35°C
② Bearing head	② Low side bearing head	Lubrication oil temperature +35°C
③ Shaft seal	③ Shaft seal	Lubrication oil temperature +20°C
	④ High side rotor casing	Lubrication oil temperature +35°C
	⑤ High side bearing head	Lubrication oil temperature +35°C

Table 2 Surface Temperature Criteria

5.4 Records

The test results are recorded in Appendix 1: Screw Compressor Test Records.

6. Vibration and Noise Tests



6.1 Purpose

Noise and vibration tests are carried out during mechanical running test to check whether the compressor's noise and vibration are within the standard shipping values or not.

6.2 Measurement Method

6.2.1 Vibration

The amplitude of vibration is measured with a general purpose vibrometer (frequency analysis of the vibration is not performed.)

	DEHDASHT PETROCHEMICAL INDUSTRY COMPANY DEHDASHT HIGH DENSITY POLYETHYLENE PROJECT		
Contract No.: DPIC/98-12	DOCUMENT TITLE: Inspection and Test Procedure for Compressor	POI: IFA	Rev.: D0
	DOCUMENT No: DPIC9812-000-VD-1002-ME-PRC-0065	Sheet 31 of 36	

6.2.2 Measurement Method

Measurement points are shown in Figures 4 and Figure 5. Using a magnetic pickup, amplitudes are measured at each point (V, H, A for single stage compressors and VL, HL, AL, VH, HH, AH for compound type compressors).

6.2.3 Noise

Noise is measured using a sound level meter as specified in the standard JIS C 1509 (2017) *Electroacoustics-Sound level meters-* in accordance with JIS B 8346 (1991) *Fans, blowers and compressors - Determination of A-weighted sound pressure level.* When the difference between the actual measurement and the background noise value is less than 10 dB, the actual measurement value should be corrected according to JIS Z 8731 (2019) *Acoustics -- Description and measurement of environmental noise.*

6.2.4 Measurement Method

Noise measurement points are shown as P-point in Figures 4 and 5.

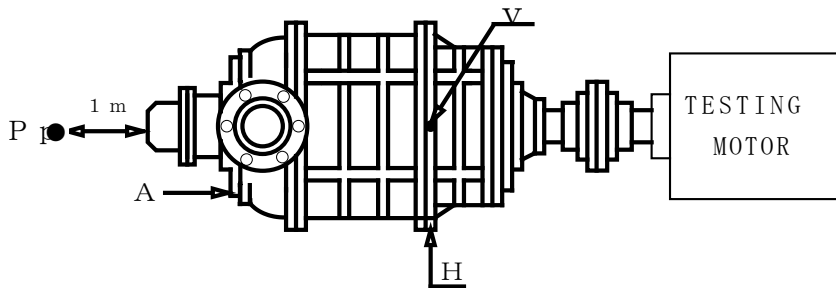

Figure 4
Single Stage Compressor

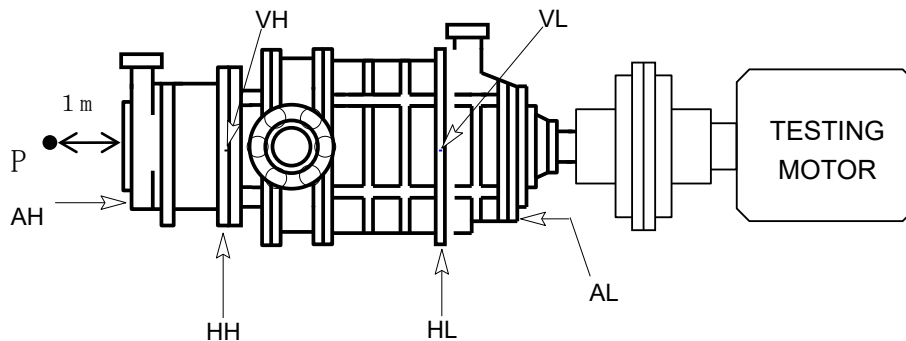



Figure 5
Compound Type Compressor

6.3 Acceptance Criteria

Compressors with results not exceeding the values shown in Table 1 *Noise and Vibration Shipment Standards for Screw Compressors* are accepted.

	DEHDASHT PETROCHEMICAL INDUSTRY COMPANY DEHDASHT HIGH DENSITY POLYETHYLENE PROJECT		
Contract No.: DPIC/98-12	DOCUMENT TITLE: Inspection and Test Procedure for Compressor	POI: IFA	Rev.: D0
	DOCUMENT No: DPIC9812-000-VD-1002-ME-PRC-0065	Sheet 32 of 36	

6.4 Records

The test results are recorded in Appendix-1: Screw Compressor Test Records.

Appendix Table 1

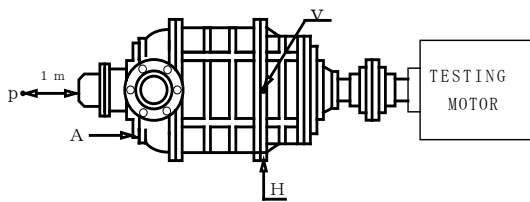

Noise and Vibration Shipment Standards for Screw Compressors

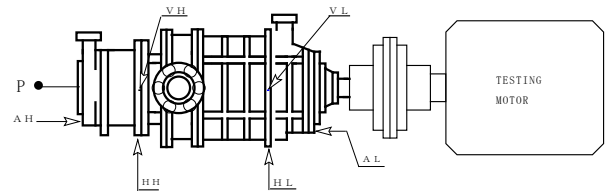

Single stage compressor



Compound type compressor

 	DEHDASHT PETROCHEMICAL INDUSTRY COMPANY DEHDASHT HIGH DENSITY POLYETHYLENE PROJECT		
	Contract No.: DPIC/98-12	DOCUMENT TITLE: Inspection and Test Procedure for Compressor DOCUMENT No: DPIC9812-000-VD-1002-ME-PRC-0065	



[Noise]

Compressor type	Discharge port	Acceptance value	Compressor type	Discharge port	Acceptance value
1 2 5 SUD	L.M.H	8 4	1 6 0 VSD	L.M.H	8 4
1 2 5 LUD	L.M.H	8 4	1 6 0 VMD	L.M.H	8 4
1 6 0 SUD	L.M.H	8 4	1 6 0 VLD	L.M.H	8 5
1 6 0 MUD	L.M.H	8 4	2 0 0 VSD	L.M.H	8 6
1 6 0 LUD	L.M.H	8 5	2 0 0 VMD	L.M.H	8 7
2 0 0 SUD	L.M.H	8 6	2 0 0 VLD	L.M.H	8 8
2 0 0 MUD	L.M.H	8 7	2 5 0 VSD	L.M.H	8 8
2 0 0 LUD	L.M.H	8 8	2 5 0 VMD	L.M.H	9 0
2 5 0 SUD	L.M.H	8 8	2 5 0 VLD	L.M.H	9 0
2 5 0 MUD	L.M.H	9 0	2 5 0 VLLD	L.M.H	9 2
2 5 0 LUD	L.M.H	9 0	3 2 0 VSD	L.M.H	9 5
3 2 0 SUD	L.M.H	9 5	3 2 0 VMD	L.M.H	9 7
3 2 0 MUD	L.M.H	9 7	3 2 0 VLD	L.M.H	9 8
3 2 0 LUD	L.M.H	9 8	4 0 0 VSD	L.M.H	1 0 3
3 2 0 LLUD	L.M.H	1 0 3	4 0 0 VMD	L.M.H	1 0 4
4 0 0 SUD	L.M.H	1 0 3	1 6 0 VSR	L.M.H	8 7
4 0 0 MUD	L.M.H	1 0 4	1 6 0 VLR	L.M.H	8 8
4 0 0 LUD	L.M.H	1 0 5	2 0 0 VSR	L.M.H	8 9
4 0 0 LLUD	L.M.H	1 0 6	2 0 0 VLR	L.M.H	9 1
4 0 0 XLUD	L.M.H	1 0 7	2 5 0 VSR	L.M.H	9 1
4 0 0 XXLUD	L.M.H	1 0 8	2 5 0 VLR	L.M.H	9 3
1610C	L.M.H	8 4	Vibration (Frequency range: 10 - 1000 Hz) (half amplitude peak value) Values in gray column are reference values as per API619		
1612C	L.M.H	8 6			
1612C 2poles Speed increasing	L.M.H	9 0			
1612C 4poles Speed increasing	L.M.H	8 8			
2 0 1 6 C	L.M.H	8 7			
2 5 2 0 C	L.M.H	9 2			
3 2 2 5 C	L.M.H	9 8			
4 0 2 5 C	L.M.H	1 0 5			
4 0 3 2 C	L.M.H	1 0 8			
1 7 0 JS	L.M.H	8 1			
1 7 0 JM	L.M.H	8 4			
1 7 0 JL	L.M.H	8 6			
2 2 0 JS	L.M.H	8 6			
2 2 0 JM	L.M.H	8 6			
2 2 0 JL	L.M.H	8 9			
2 8 0 JS	L.M.H	8 8			
2 8 0 JM	L.M.H	9 0			
2 8 0 JL	L.M.H	9 2			

Type	Measurement points	Allowance value for amplitude µm (half amplitude peak value)	allowance value for velocity mm/s (RMS)
Single stage Compressors	V	2 0	8
	H	2 0	8
	A	2 0	8
Compound type two stage compressors	VH	2 0	8
	HH	2 0	8
	AH	2 0	8
	VL	2 0	8
	HL	2 0	8
	AL	2 0	8

This document is the property of DPIC. Any unauthorized attempt to reproduce it, in any form, is strictly prohibited.

* This criteria is acceptable for the downward discharge type compressors.

	DEHDASHT PETROCHEMICAL INDUSTRY COMPANY DEHDASHT HIGH DENSITY POLYETHYLENE PROJECT		
Contract No.: DPIC/98-12	DOCUMENT TITLE: Inspection and Test Procedure for Compressor	POI: IFA	Rev.: D0
	DOCUMENT No: DPIC9812-000-VD-1002-ME-PRC-0065	Sheet 34 of 36	

Appendix Table 2

Measurement Equipment List

*This list is only for reference. Actual instruments differ depending on test benches.

Name	Use place	Registration No.	Type	Term of validity
U tube manometer	Pressure Before Orifice	AA11007	PM12-231 (0~14.6kPa)	May, 2014
	Suction Pressure	AA11008	PM12-231 (0~14.6kPa)	May, 2014
	Differential Pressure Across Orifice	AA11009	PM12-231 (0~14.6kPa)	May, 2014
Bourdon tube pressure gauge	Discharge Pressure	AA20201	DU3/8 x 150mm x 2.0MPa	Aug., 2011
	Oil Pressure	AA20202	DU1/2 x 50mm x 2.0MPa	Aug., 2011
Aneroid atmospheric meter	Atmospheric Pressure	AA-AK002	930~1070hPa	March, 2012
Strain gauge type torque meter	Running Torque	AATQ008	TMNR-5KNM	Aug., 2011
Rotating meter		AAPR003	HT-4200	Oct., 2011
Bar type thermometer	Suction Temperature	On48	Alcohol temperature gauge	Jan., 2012
	Discharge Temperature	On50		Jan., 2012
	Temperature Before Orifice	On70		Jan., 2012
	Oil Temperature	On54		Jan., 2012
Noise meter		AA-SN004	NL-26	March, 2014
Vibration meter		AA-SD004	VM-83	July, 2013
Bar type thermometer	Rotor casing	On17	Alcohol temperature gauge	Jan., 2012
	Bearing head	On67		Jan., 2012
	Shaft seal	On51		Jan., 2012
Motors		No.7	6300V x 2100KW x 2P x 4000rpm	

Instruments above are regularly calibrated according to the company rules.



DEHDASHT PETROCHEMICAL INDUSTRY COMPANY
DEHDASHT HIGH DENSITY POLYETHYLENE PROJECT



Contract No.: DPIC/98-12

DOCUMENT TITLE: Inspection and Test Procedure for Compressor

POI: IFA

Rev.: D0

DOCUMENT No: DPIC9812-000-VD-1002-ME-PRC-0065

Sheet 35 of 36

SAMPLE

[Appendix 1 : Screw Compressor Test Records 1/3]

MYCOM

Report No. 0

Screw Compressor Test Record

Item No.	: -
Date	: January 0, 1900
Model	: 0
Serial No.	: 0
Test fluid	: AIR
Orifice No.	: 0
Time	: 0:00
Inspection items	: Internal test

SURVEYOR

Revolutions	0	min ⁻¹
Running Time	0.0	N.
Room Temperature	0.0	°C
Atmospheric Pressure	0.0	kPa
Discharge Pressure	0.0	kPa
Suction Pressure	L(0.00) kPa R(0.00) kPa	0.00 kPa
Pressure Before Orifice	L(0.00) kPa R(0.00) kPa	0.00 kPa
Pressure Difference at Orifice	L(0.00) kPa R(0.00) kPa	0.00 kPa
Oil Pressure	0.00	MPa.G
Suction Temperature	0.0	°C
Temperature Before Orifice	0.0	°C
Oil Temperature	0.0	°C
Discharge Temperature	0.0	°C

Noise	0.0	dB (A)
Background Noise	0.0	dB (A)

TEST RESULTS;

Temp. of Rotor Casing	0.0	°C
Temp. of Bearing Head	0.0	°C
Temp. of Shaft Seal	0.0	°C
Test of Vibration	V	0 μm
	H	0 μm
	A	0 μm

Approved by : _____

Checked by : _____



DEHDASHT PETROCHEMICAL INDUSTRY COMPANY
DEHDASHT HIGH DENSITY POLYETHYLENE PROJECT



Contract No.: DPIC/98-12	DOCUMENT TITLE: Inspection and Test Procedure for Compressor	POI: IFA	Rev.: D0
	DOCUMENT No: DPIC9812-000-VD-1002-ME-PRC-0065	Sheet 36 of 36	

SAMPLE
[Appendix 1 : Screw Compressor Test Records 2/3]



Report No. 0

Screw Compressor Test Results

SURVEYOR

GENERAL INFORMATION;

Item No. :
Model :
Serial No. :
Date : January 0, 2000
Tested at : MAYEKAWA MFG. CO.,LTD. MORIYA PLANT
2000, Tatsuzawa Moriya-City, Ibaraki Pref., 302-0118, Japan

PERFORMANCE TEST ;

	STANDARD	ACTUAL	Judgment	CRITERIA
Capacity (m ³ /h) :	1.0	2.0 (200.0 %)	Accepted	95% and more
Brake Kilowatts (BkW) :	3.0	4.0 (133.3 %)	Accepted	105% or less

MECHANICAL RUNNING TEST ;

	ALLOWABLE MAXIMUM	ACTUAL	Judgment
Temp. of Rotor Casing :	35.0	0.0 °C	Accepted
Temp. of Bearing Head :	35.0	0.0 °C	Accepted
Temp. of Shaft Seal :	20.0	0.0 °C	Accepted

VIBRATION AND NOISE TESTS ;

	ALLOWABLE MAXIMUM	ACTUAL	Judgment
Noise :	92	0.0 dB(A)	Accepted
Vibration (Frequency range : 10 - 1000Hz)			
V : :	20	0 μm	Accepted
H : :	20	0 μm	Accepted
A : :	20	0 μm	Accepted

Approved by : _____ Checked by : _____