



LIDCO, Pars SEE Zone, Assaluyeh,
Integrated Methanol and Ammonia
Plant 3000 MTPD MeOH / 900 MTPD NH3 PROJECT



Outline Dimensional Drawings for LCP Panel and Junction Box

Document No. 17735-07

Project No.	Vendor Doc.	P.O. No.	Department	Document Type	Serial No	Revision	Page
N278	VD	6019	IN	DWG	0007	05	Page 1 of 6

**Airpack B.V. - Air Compressor –
Integrated Methanol and Ammonia Plant
17735-COM Outline Dimensional Drawings for LCP Panel and
Junction Box (K020)**

05	18-04-2024	Issued for Approval	R.T.	S.K.	J.J.
04	20-03-2024	Issued for Approval	R.T.	S.K.	J.J.
03	14-02-2024	Issued for Approval	R.T.	S.K.	J.J.
02	21-12-2023	Issued for Approval	R.T.	S.K.	J.J.
01	07-12-2023	Issued for Approval	R.T.	S.K.	J.J.
REV.	DATE	DESCRIPTION	DRAWN	CHECKED	APPROVED

This document has been produced by Contractor for LIDCO. It is confidential and cannot be disclosed to or used by any third party for any purpose without prior written consent.

Outline Dimensional Drawings for LCP Panel and Junction Box

Document No. 17735-07

Project No.	Vendor Doc.	P.O. No.	Department	Document Type	Serial No	Revision	Page
N278	VD	6019	IN	DWG	0007	05	Page 2 of 6

LIST OF REVISED PAGES

Rev. Page	01	02	03	04	05	Rev. Page	01	02	03	04	05	Rev. Page	01	02	03	04	05	Rev. Page	01	02	03	04	05
1	X	X	X	X	X	26						51						76					
2	X	X	X	X	X	27						52						77					
3	X	X	X	X	X	28						53						78					
4	X	X	X	X	X	29						54						79					
5	X	X	X	X	X	30						55						80					
6	X	X	X	X	X	31						56						81					
7						32						57						82					
8						33						58						83					
9						34						59						84					
10						35						60						85					
11						36						61						86					
12						37						62						87					
13						38						63						88					
14						39						64						89					
15						40						65						90					
16						41						66						91					
17						42						67						92					
18						43						68						ATTACHMENT					
19						44						69						1					
20						45						70						2					
21						46						71						3					
22						47						72						4					
23						48						73						5					
24						49						74						6					
25						50						75						7					

Nr.	Description	Tag Number	Qty	Make	Order Number
1	Compressor Running Lamp (Green)	3H4	1	Schneider Electric	XB4BVB3
2	Compressor Operatinal Lamp (Green)	3H6	1	Schneider Electric	XB4BVB3
3	Common Alarm Lamp (Amber)	3H8	1	Schneider Electric	XB4BVB5
4	Common Trip Lamp (Red)	3H10	1	Schneider Electric	XB4BVB4
5	Compressor Start Pushbutton (Green)	2S4	1	Schneider Electric	XB4BA31
6	Compressor Stop Pushbutton (Red)	2S6	1	Schneider Electric	XB4BA42
7	Local/Remote Selector Switch	2S8	1	Schneider Electric	XB4BD21
8	Emergency Stop Pushbutton (Red Mushroom Type with Protective Cover)	4S4	1	Schneider Electric	XB5AS8444

Terminal Strip Definition

300TDD820	Connection Pushbuttons and Lamps	300TDD820	28	Phoenix Contact	UT 4
300TED820	Connection ESD Pushbutton	300TED820	4	Phoenix Contact	UT 4

05	02/04/24	ISSUED FOR REVIEW	RT	SK	KP
04	20/03/24	ISSUED FOR REVIEW	RT	SK	KP
03	14/02/24	ISSUED FOR REVIEW	RT	SK	KP
02	21/12/23	ISSUED FOR REVIEW	RT	SK	KP

REV.	DATE	DESCRIPTION	DRAWN	CHECK	APPROVED
CLIENT: 			CONTRACTOR: 		VENDOR: 

THIS DOCUMENT HAS BEEN PRODUCED BY CONTRACTOR FOR LIDCO IT IS CONFIDENTIAL AND CANNOT BE DISCLOSED TO OR USED BY ANY THIRD PARTY FOR ANY PURPOSE, WITHOUT PRIOR WRITTEN CONSENT.

PROJECT TITLE:
**LIDCO, Pars SEE Zone, Assaluyeh
Integrated Methanol and Ammonia Plant
3000 MTPD MeOH/900 MTPD NH3 PROJECT**

DRAWING TITLE:
Outline Dimensional Drawings for LCP Panel and Junction Box

DOCUMENT No:
17735-07 Panel Layout Diagram

SC.
SIZE: **A3**

PROJECT No.	VENDOR DOC.	P.O. No.	DEPARTMENT	DOC. TYPE	SERIAL No.	REV.	SHEET No.
N278	VD	6019	IN	DWG	0007	05	1 OF 4

NOTES
1) Tags correspond to tags on wiring diagram,
N-278-VD-6019-IN-DIA-0005

300LP-820 Local Pushbutton Station

Front Side (Outside View)

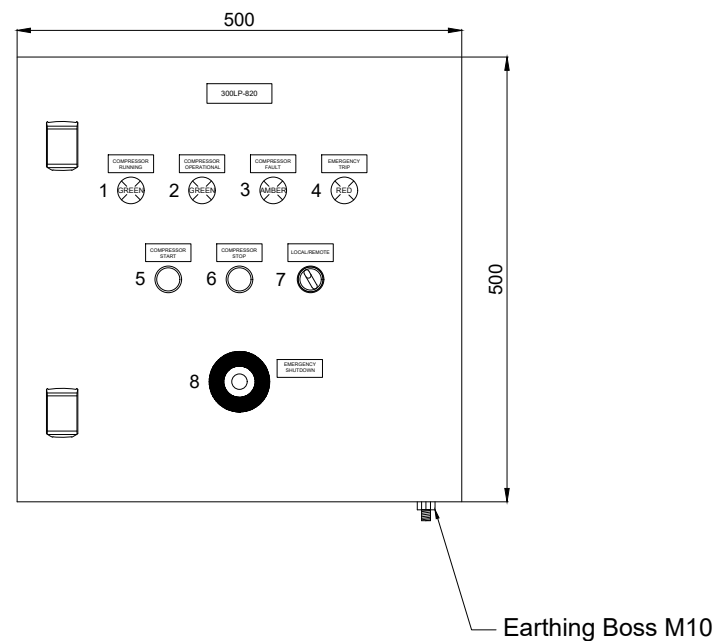

Front Side (Inside View)

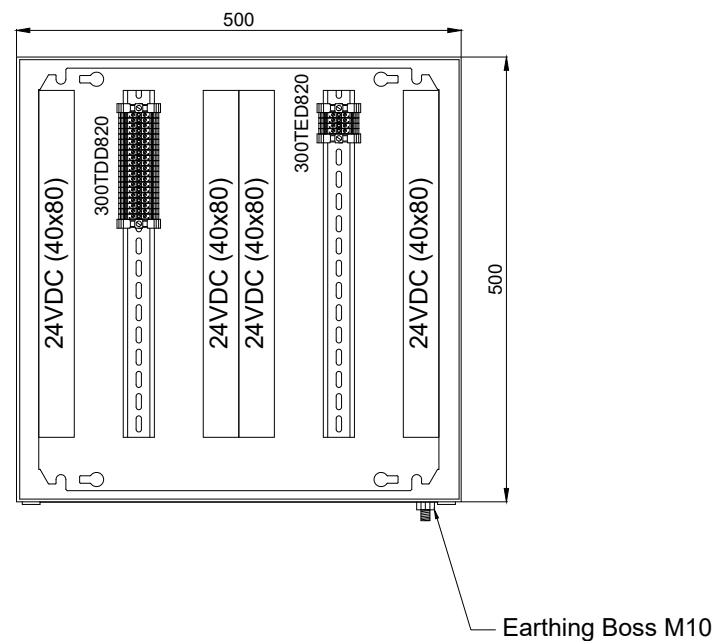

Left Side View

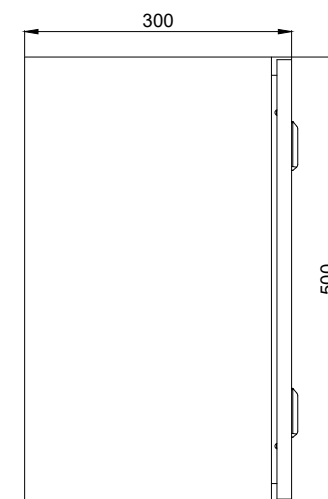

Back View

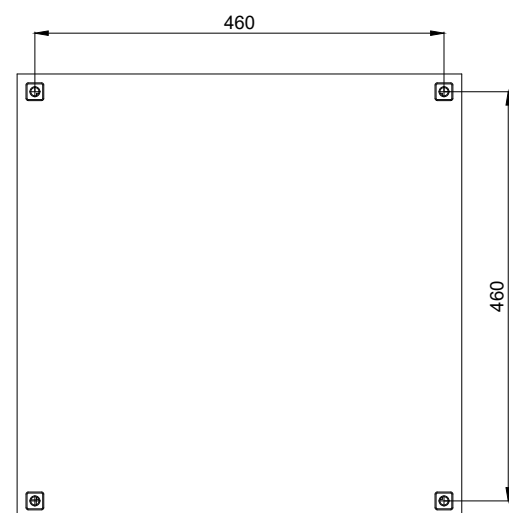

Bottom View

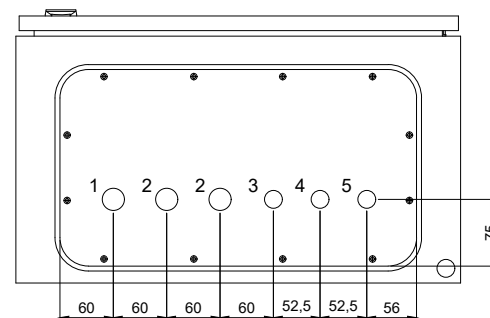

Gland Entry Details

1. M25 - 1x (Incoming Cable from Customer, Pushbuttons)
2. M25 - 1x (Incoming Cable from Customer, Lamps)
3. M25 - 1x (Spare, fitted with Ex blank)
4. M20 - 1x (Incoming Cable from Customer, ESD Pushbutton)
5. M20 - 1x (Spare, fitted with Ex blank)
6. M20 - 1x (Breather)

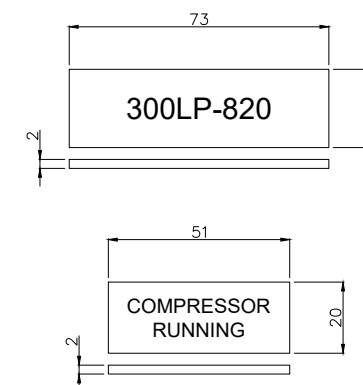

REV.	DATE	DESCRIPTION	DRAWN	CHECK	APPROVED
05	02/04/24	ISSUED FOR REVIEW	RT	SK	KP
04	20/03/24	ISSUED FOR REVIEW	RT	SK	KP
03	14/02/24	ISSUED FOR REVIEW	RT	SK	KP
02	21/12/23	ISSUED FOR REVIEW	RT	SK	KP

CLIENT:		CONTRACTOR:		VENDOR:	
---------	--	-------------	--	---------	--

THIS DOCUMENT HAS BEEN PRODUCED BY CONTRACTOR FOR LIDCO IT IS CONFIDENTIAL AND CANNOT BE DISCLOSED TO OR USED BY ANY THIRD PARTY FOR ANY PURPOSE, WITHOUT PRIOR WRITTEN CONSENT.

PROJECT TITLE:	LIDCO, Pars SEE Zone, Assaluyeh Integrated Methanol and Ammonia Plant 3000 MTPD MeOH/900 MTPD NH3 PROJECT
----------------	--



DRAWING TITLE:	Outline Dimensional Drawings for LCP Panel and Junction Box
----------------	---

DOCUMENT No:	17735-07 Panel Layout Diagram	SC:	
		SIZE:	A3

PROJECT No.	VENDOR DOC.	P.O. No.	DEPARTMENT	DOC. TYPE	SERIAL No.	REV.	SHEET No.
N278	VD	6019	IN	DWG	0007	05	2 OF 4

- NOTES
- 1) Panel Dimensions: 500x500x300mm
 - 2) Panel Material: Painted Sheet Steel (RAL 7035)
 - 3) Panel Thickness: 1.5mm
 - 4) Area Classification: Safe
 - 5) Ingress Protection: IP65
 - 6) Cable Raceways will have 20% spare space.
 - 7) Panel Weight: ~25kg
 - 8) Manufacturer: Rittal
 - 9) Model Number: 1350000
 - 10) DIN Rail Type: NS35
 - 11) Emergency Shutdown Pushbutton shall have protective cover to avoid inadvertent shutdown.
 - 12) Cable glands will CMP Cable Glands, SS316 with shrouds, IP66 rated.

Nr.	Description	Tag Number	Qty	Make	Order Number
Terminal Strip Definition					
300TDA820	Connection Analog Transmitters to Client	300TDA820	48	Phoenix Contact	UT 4
300TDA821	Connection Pressure Control Valve to Client	300TDA821	10	Phoenix Contact	UT 4

05	02/04/24	ISSUED FOR REVIEW	RT	SK	KP		
04	20/03/24	ISSUED FOR REVIEW	RT	SK	KP		
03	14/02/24	ISSUED FOR REVIEW	RT	SK	KP		
02	21/12/23	ISSUED FOR REVIEW	RT	SK	KP		
REV.	DATE	DESCRIPTION	DRAWN	CHECK	APPROVED		
CLIENT:		CONTRACTOR:		VENDOR:			
							
<small>THIS DOCUMENT HAS BEEN PRODUCED BY CONTRACTOR FOR LIDCO IT IS CONFIDENTIAL AND CANNOT BE DISCLOSED TO OR USED BY ANY THIRD PARTY FOR ANY PURPOSE, WITHOUT PRIOR WRITTEN CONSENT.</small>							
PROJECT TITLE:							
LIDCO, Pars SEE Zone, Assaluyeh Integrated Methanol and Ammonia Plant 3000 MTPD MeOH/900 MTPD NH3 PROJECT							
DRAWING TITLE:							
Outline Dimensional Drawings for LCP Panel and Junction Box							
DOCUMENT No:					SC.		
17735-07 Panel Layout Diagram					SIZE: A3		
PROJECT No.	VENDOR DOC.	P.O. No.	DEPARTMENT	DOC. TYPE	SERIAL No.	REV.	SHEET No.
N278	VD	6019	IN	DWG	0007	05	3 OF 4

NOTES

- 1) Tags correspond to tags on wiring diagram,
N-278-VD-6019-IN-DIA-0005

300JDAN-820 Junction Box

Front Side (Outside View)

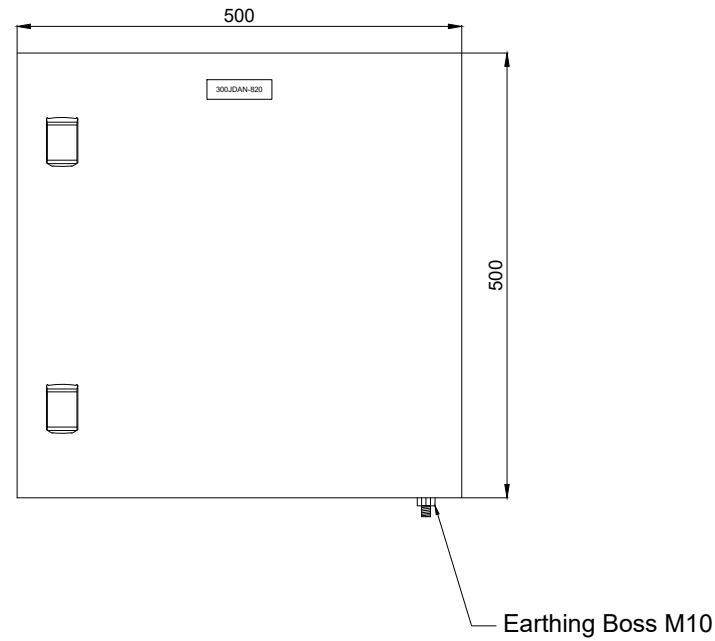

Front Side (Inside View)

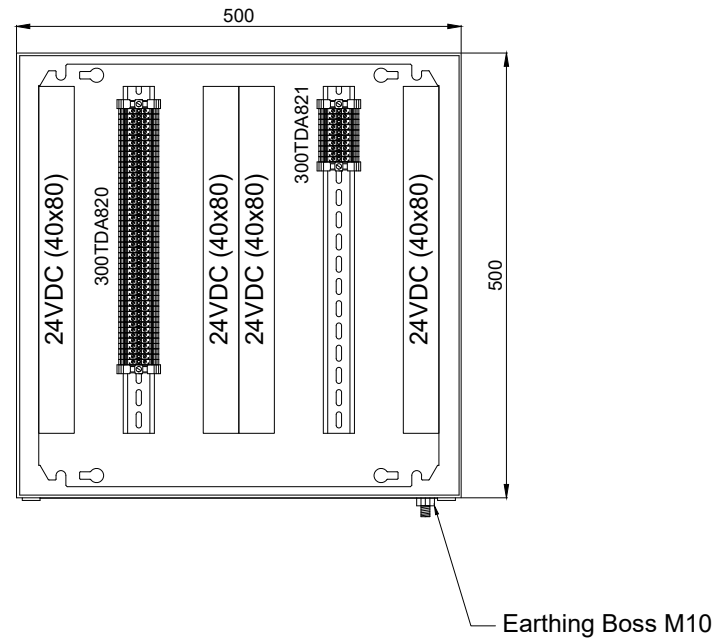

Left Side View

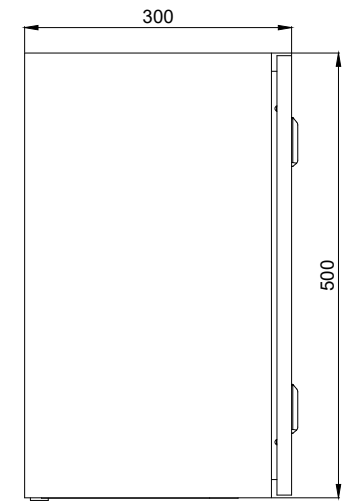

Back View

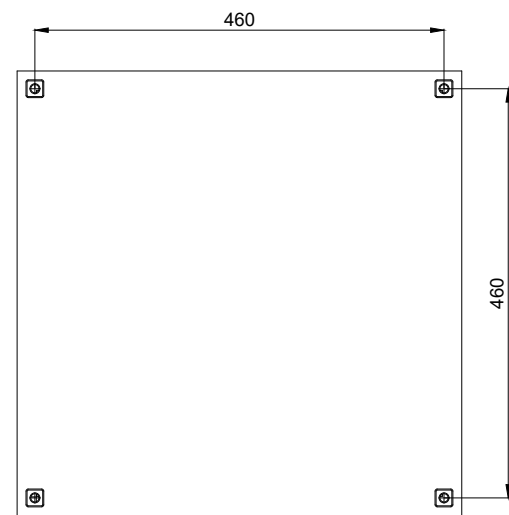

Bottom View

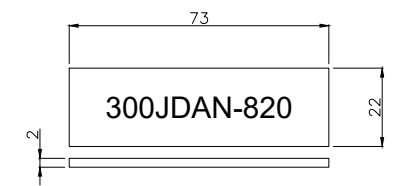
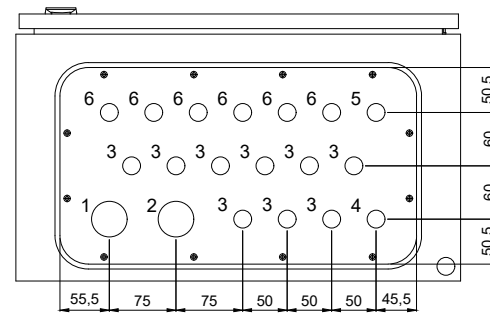

Gland Entry Details

1. M40 - 1x (Incoming Cable from Customer, Transmitters)
2. M40 - 1x (Spare, fitted with Ex blank)
3. M20 - 9x (Transmitters)
4. M20 - 1x (Breather)
5. M20 - 1x (Pressure Control Valve)
6. M20 - 6x (Spares, fitted with Ex blank)

NOTES

- 1) Panel Dimensions: 500x500x300mm
- 2) Panel Material: Painted Sheet Steel (RAL 7035)
- 3) Panel Thickness: 1.5mm
- 4) Area Classification: Safe
- 5) Ingress Protection: IP65
- 6) Cable Raceways will have 20% spare space.
- 7) Panel Weight: ~25kg
- 8) Manufacturer: Rittal
- 9) Model Number: 1350000
- 10) DIN Rail Type: NS35
- 11) Cable glands will CMP Cable Glands, SS316 with shrouds, IP66 rated.

REV.	DATE	DESCRIPTION	DRAWN	CHECK	APPROVED
05	02/04/24	ISSUED FOR REVIEW	RT	SK	KP
04	20/03/24	ISSUED FOR REVIEW	RT	SK	KP
03	14/02/24	ISSUED FOR REVIEW	RT	SK	KP
02	21/12/23	ISSUED FOR REVIEW	RT	SK	KP

CLIENT:	CONTRACTOR:	VENDOR:
 Lavan Industry Company	 NARGAN	 Airpack

THIS DOCUMENT HAS BEEN PRODUCED BY CONTRACTOR FOR LIDCO IT IS CONFIDENTIAL AND CANNOT BE DISCLOSED TO OR USED BY ANY THIRD PARTY FOR ANY PURPOSE, WITHOUT PRIOR WRITTEN CONSENT.

PROJECT TITLE:	LIDCO, Pars SEE Zone, Assaluyeh Integrated Methanol and Ammonia Plant 3000 MTPD MeOH/900 MTPD NH3 PROJECT
----------------	--

DRAWING TITLE:	Outline Dimensional Drawings for LCP Panel and Junction Box
----------------	---

DOCUMENT No:	17735-07 Panel Layout Diagram	SC.
		SIZE: A3

PROJECT No.	VENDOR DOC.	P.O. No.	DEPARTMENT	DOC. TYPE	SERIAL No.	REV.	SHEET No.
N278	VD	6019	IN	DWG	0007	05	4 OF 4