







OWNER:  شرکت سست و سویی توستر ایرانیاان (سهایی نیاان)	<b>BUSHEHR PETROCHEMICAL COMPANY MEG PLANT</b>						EPC CONTRACTOR:  Chagalesh-Enerchimi-Steam Joint Venture BUPC-MEG PLANT PROJECT		
MC :  شرکت سست و سویی توستر ایرانیاان (سهایی نیاان)	<b>PULSATION DAMPER MECHANICAL STRENGHT CALCULATION FOR NITROGEN GAS BOOSTER</b>						 Netherlands		
	Project	Area	Phase	Unit	Dis.	Doc.	Seq.	Contract No : 52-98/445	
Owner Document Number: 17811-24C	BU	20	VD	303	ME	CAL	0026	Rev.:	Page
								03	1 of 120

See page 34.

## PULSATION DAMPER MECHANICAL STRENGHT CALCULATION FOR NITROGEN GAS BOOSTER

 شرکت سست و سویی توستر ایرانیاان شرکت سست و سویی توستر ایرانیاان توسعه کیرانیاان	 Chagalesh-Enerchimi-Steam Joint Venture BUPC-MEG PLANT PROJECT	<b>BUSHEHR PETROCHEMICAL COMPANY MEG PLANT</b>
<b>Document Review</b>		
Issue Purpose:	AFC	
Result Code: AP,AN,CM,RE,NC	AN	
Next Status : IFC,IFA,IFI,AFC,AB	AFC	
Responsible Department	MECHANICAL	
Commented Date	Jun /26/2022	
<b>Approval or review hereunder shall not be construed to relieve Vendor / Subcontractor of his responsibilities and liability under the contract.</b>		

03	27/06/2022	<b>Approved for Construction</b>	KP	CL	JR	
02	23/06/2022	<b>For Information</b>	KP	CL	JR	
01	09/05/2022	<b>For Information</b>	KP	CL	JR	
00	26/04/2022	<b>For Information</b>	KP	CL	JR	
Rev.	Date	Purpose of Issue	Prepared	Checked	Approved	AC Code
					Class: 1	Phase: P



# Report – 2nd-stage Discharge\_LI4736 C220006CLC012

## **PV-Elite Calculation Summary**

Client: Airpack Nederland BV.  
Client location: Zierikzee  
Ref number client: 17811-OO-0702(KP)

### **PPV Engineering**

Author: H.Hoezen  
- Telephone: +31 (0)594 581010  
- E-mail: h.hoezen@ppv-engineering.nl

June 22, 2022  
Order number: P22-115-01  
Document number: 22-11501-C03  
Revision: 1

# Table of Contents

Cover Sheet .....	2
Vessel Design Summary: .....	3
Nozzle Summary: .....	5
Nozzle Schedule: .....	6
Bill of Material: .....	7
Input Echo: .....	8
Internal Pressure Calculations: .....	13
Nozzle Flange MAWP: .....	18
Nozzle Calcs.: N2 .....	19
Nozzle Calcs.: N3 .....	22
Nozzle Calcs.: N1 .....	25

N2 Pulsation damper second stage suction  
C220006CLC011  
Static Calculation

**DESIGN CALCULATION**

*In Accordance with ASME Section VIII Division 1*

ASME Code Version : 2021

Analysis Performed by : PPV-Engineering B.V.

Job File : ...\\2nd-stage Suction\_LI4735.pvdb

Date of Analysis : Jun 21,2022 9:05am

**PV Elite 24 SP1, March 2022**

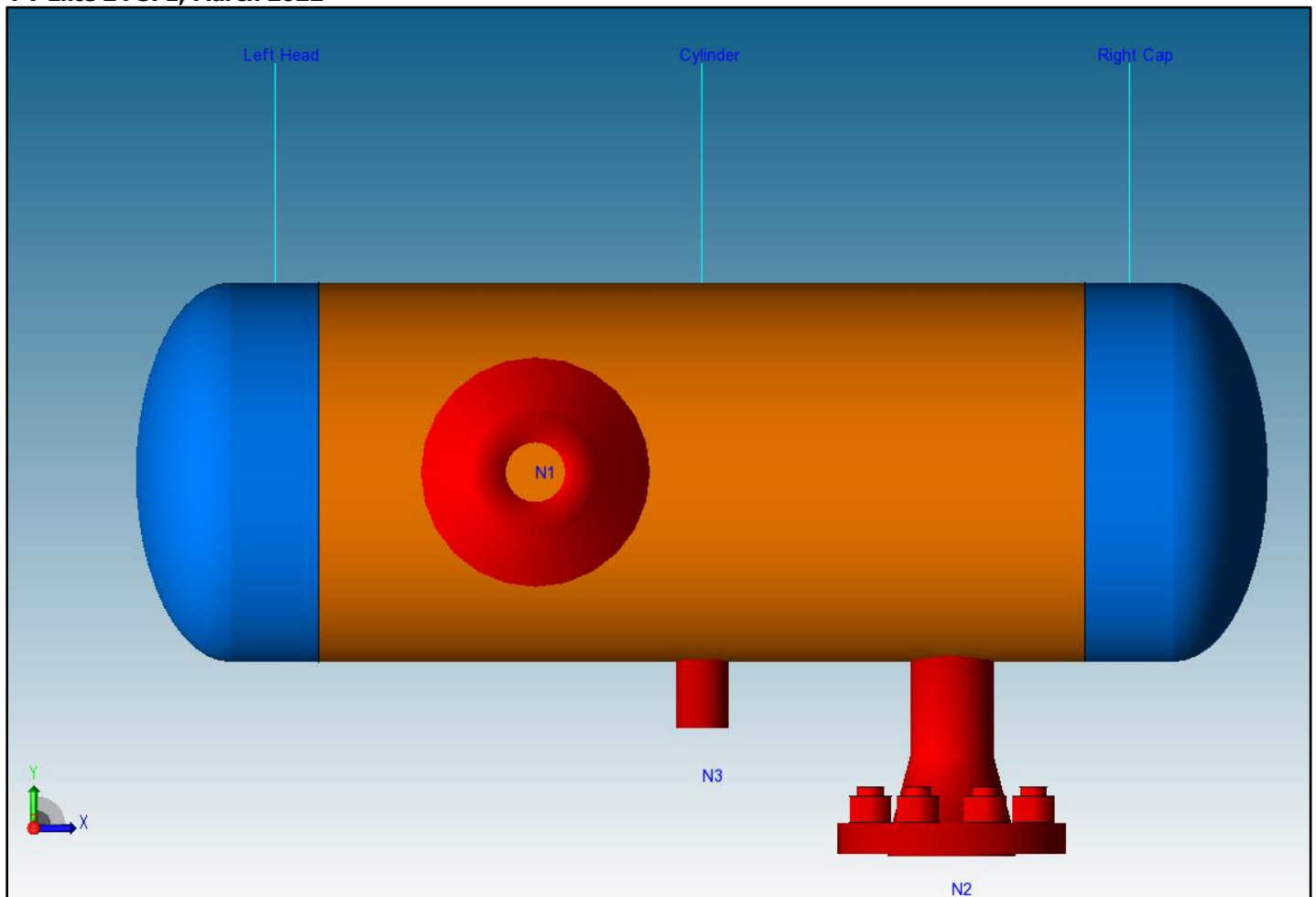

N2 Pulsation damper second stage suction  
C220006CLC011

Static Calculation

PV Elite 24 SP1 Licensee: PPV-Engineering B.V.

FileName : 2nd-stage Suction\_LI4735

Vessel Design Summary: Step: 15 9:05am Jun 21, 2022

### Vessel Design Summary:

#### ASME Code, Section VIII Division 1, 2021

Diameter Spec : 273.000 mm OD	
Vessel Design Length, Tangent to Tangent	678.72 mm
Specified Datum Line Distance	63.36 mm
Internal Design Temperature	85 °C
Internal Design Pressure	2.400 MPa
External Design Temperature	85 °C
Maximum Allowable Working Pressure	3.809 MPa
Shop Test Pressure	6.640 MPa
Required Minimum Design Metal Temperature	-28.9 °C
Warmest Computed Minimum Design Metal Temperature	-46.0 °C
Wind Design Code	No Wind Loads
Earthquake Design Code	No Seismic

### Materials of Construction:

Component Type	Material	Class	Thickness	UNS #	Normalized	Impact Tested
Shell	SA-106 B	...	...	K03006	No	No
Head	SA-234 WPB	...	...	K03006	No	No
Nozzle	SA-106 B	...	...	K03006	No	No
Nozzle Flg	SA-105	...	...	K03504	No	No

Normalized is determined based on the UCS-66 material curve selection and Figure UCS-66.  
Impact Tested is based on material selection and material data properties.

### Element Pressures and MAWP (MPa & mm):

Element Description or Type	Design Pressure + Stat. head	Ext. Press.	Element M.A.W.P	Total Corrosion Allowance	Str. Flg. Gov.	In Creep Range
Left Head	2.400	0.00	4.690	3.0000	Yes	No
Cylinder	2.400	0.00	3.809	3.0000	N/A	No
Right Cap	2.400	0.00	4.690	3.0000	Yes	No

### Element Types and Properties:

Element Type	"To" Elev mm	Element Length mm	Nominal Thickness mm	Finished Thickness mm	Reqd Thk Internal mm	Reqd Thk External mm	Long Eff	Circ Eff
Ellipse	0.0	63.4	9.3	9.3	6.1	...	0.85	0.85
Cylinder	552.0	552.0	9.3	8.1	6.2	...	0.85	0.85
Ellipse	615.4	63.4	9.3	9.3	6.1	...	0.85	0.85

N2 Pulsation damper second stage suction  
C220006CLC011

Static Calculation

PV Elite 24 SP1 Licensee: PPV-Engineering B.V.

FileName : 2nd-stage Suction\_LI4735 -----

Vessel Design Summary: Step: 15 9:05am Jun 21,2022

**Weights:**

Fabricated - Bare W/O Removable Internals	63.3	kgm
Shop Test - Fabricated + Water ( Full )	102.6	kgm
Shipping - Fab. + Rem. Intls.+ Shipping App.	63.3	kgm
Erected - Fab. + Rem. Intls.+ Insul. (etc)	63.3	kgm
Empty - Fab. + Intls. + Details + Wghts.	63.3	kgm
Operating - Empty + Operating Liquid (No CA)	63.3	kgm
Field Test - Empty Weight + Water (Full)	102.6	kgm

**PV Elite is a trademark of Hexagon AB, 2022, All rights reserved.**

N2 Pulsation damper second stage suction

C220006CLC011

Static Calculation

PV Elite 24 SP1 Licensee: PPV-Engineering B.V.

FileName : 2nd-stage Suction\_LI4735

Nozzle Summary:

Step: 13 9:05am Jun 21, 2022

### Nozzle Calculation Summary (MPa & mm):

Description	MAWP	Ext	MAPNC	UG-45	[tr]	Weld Path	Areas or Stresses
N2	3.809	...	...	OK	5.68	OK	No Calc[*]
N3	3.809	...	...	OK	5.68	OK	No Calc[*]
N1	3.809	...	...	OK	5.68	OK	No Calc[*]

### Nozzle MAWP Summary:

Minimum MAWP Nozzles : 3.809 Nozzle : N1  
 Minimum MAWP Shells/Flanges : 3.809 Element : Cylinder  
 Minimum MAPnc Shells/Flanges : 6.099 Element : Cylinder

Computed Vessel M.A.W.P. : 3.809 MPa

[\*] - This was a small opening and the areas were not computed.

Note: MAWPs (Internal Case) shown above are at the High Point.

*Multiple output lines for the same nozzle indicates required Code calculations in both the longitudinal and circumferential planes of reinforcement where applicable.*

### Check the Spatial Relationship between the Nozzles:

From Node	Nozzle Description	X Coordinate mm	Layout Angle deg	Dia. Limit mm
20	N2	519.360	270.000	97.700
20	N3	339.360	270.000	54.672
20	N1	219.360	0.000	97.700

### The nozzle spacing is computed by the following:

= sqrt( ll<sup>2</sup> + lc<sup>2</sup> ) where

ll - Arc length along the inside vessel surface in the long. direction.

lc - Arc length along the inside vessel surface in the circ. direction

If any interferences/violations are found, they will be noted below.

No interference violations have been detected!

**PV Elite is a trademark of Hexagon AB, 2022, All rights reserved.**

## N2 Pulsation damper second stage suction

C220006CLC011

## Static Calculation

PV Elite 24 SP1 Licensee: PPV-Engineering B.V.

FileName : 2nd-stage Suction\_LI4735

Nozzle Schedule:

Step: 12 9:05am Jun 21, 2022

**Nozzle Schedule:**

Description	Nominal or Actual Size	Schd or FVC Type	Flg Type	Nozzle O/Dia mm	Wall Thk mm	Reinforcing Pad Diameter	Pad Thk mm	Cut Length mm	Flg Class
N3	38 mm	Actual	None	38.1	8.382	...	...	57	...
N2	50 mm	160	WNF	60.3	8.738	...	...	79	300
N1	50 mm	160	WNF	60.3	8.738	...	...	68	...

*General Notes for the above table:*

The Cut Length is the Outside Projection + Inside Projection + Drop + In Plane Shell Thickness. This value does not include weld gaps, nor does it account for shrinkage.

In the case of Oblique Nozzles, the Outside Diameter must be increased. The Re-Pad WIDTH around the nozzle is calculated as follows:  
Width of Pad = (Pad Outside Dia. (per above) - Nozzle Outside Dia.)/2

For hub nozzles, the thickness and diameter shown are those of the smaller and thinner section.

**Nozzle Material and Weld Fillet Leg Size Details (mm):**

Description	Material	Shl Grve Weld	Noz Shl/Pad Weld	Pad OD Weld	Pad Grve Weld	Inside Weld
N3	SA-106 B	8.340	6.000	...	...	...
N2	SA-106 B	8.340	6.000	...	...	...
N1	SA-106 B	8.340	6.000	...	...	...

Note: The Outside projections below do not include the flange thickness.

**Nozzle Miscellaneous Data:**

Description	Elev/Distance From Datum mm	Layout Angle deg	Proj Outside mm	Proj Inside mm	Installed in Component
N3	276.000	270.0	47.62	0.00	Cylinder
N2	456.000	270.0	68.00	0.00	Cylinder
N1	156.000	0.0	57.00	0.00	Cylinder

PV Elite is a trademark of Hexagon AB, 2022, All rights reserved.

N2 Pulsation damper second stage suction

C220006CLC011

Static Calculation

PV Elite 24 SP1 Licensee: PPV-Engineering B.V.

FileName : 2nd-stage Suction\_LI4735 -----

Bill of Material: Step: 11 9:05am Jun 21,2022

**Bill of Materials:**

QTY	DESCRIPTION	MATERIAL
2	ELLIPTICAL HEAD: 2.0 X 1, 9.3mm THK X 254.5mm ID X 63.4mm	SA-234 WPB
1	CYLINDER: 9.3mm THK X 256.8mm ID X 552.0mm	SA-106 B
1	NAMEPLATE	...

PV Elite is a trademark of Hexagon AB, 2022, All rights reserved.

N2 Pulsation damper second stage suction

C220006CLC011

Static Calculation

PV Elite 24 SP1 Licensee: PPV-Engineering B.V.

FileName : 2nd-stage Suction\_LI4735

Input Echo: Step: 1 9:05am Jun 21, 2022

### Units used in this Analysis (SI\_ASME):

Name	System Unit	Constant	User Unit
Length	Feet	304.8000	mm
Force	Pounds	4.4480	N
Mass	Pounds	0.4536	kgm
Area	sq. inches	645.1600	mm <sup>2</sup>
Moment	ft. lbs.	1356.3000	N-mm
Stress	lbs./sq.in.	0.0069	MPa
Temperature	Degrees F	0.5556	°C
Pressure	psig	0.0069	MPa
Elast. Modulus	lbs./sq.in.	0.0069	MPa
Pipe Density	lbs./cu.in.	0.0277	kg/cm <sup>3</sup>
Ins. Density	lbs./cu.ft.	0.1602E-04	kg/cm <sup>3</sup>
Fluid Density	lbs./cu.ft.	0.1602E-04	kg/cm <sup>3</sup>
Wind Speed	miles/hr	1.6093	km/hr
Tray Weight	lbs./sq.ft.	0.0005	kg/cm <sup>2</sup>
Inertia	in.**4	416231.0000	mm**4
G Load	G's	1.0000	g's
Wind Load	lbs./sq.ft.	0.0479	kPa
Elevation	Feet	304.8000	mm
Volume	in.**3	0.0164	ltr
Diameter	inches	25.4000	mm
Thickness	inches	25.4000	mm

### PV Elite Vessel Analysis Program: Input Data

N2 Pulsation damper second stage suction

C220006CLC011

Static Calculation

Design Internal Pressure (for Hydrotest)	2.4	MPa
Design Internal Temperature	85.0	°C
Projection of Nozzle from Vessel Top	0	mm
Projection of Nozzle from Vessel Bottom	0	mm
Minimum Design Metal Temperature	-28.9	°C
Type of Construction	Welded	
Special Service	None	
Degree of Radiography	RT-3	
Use Higher Longitudinal Stresses (Flag)	Y	
Select t for Internal Pressure (Flag)	N	
Select t for External Pressure (Flag)	N	
Select t for Axial Stress (Flag)	N	
Select Location for Stiff. Rings (Flag)	N	
Consider Vortex Shedding	N	

### Shop Pressure Test:

Type of Pressure Test User Entered Pressure  
 Pressure Test Position Horizontal

Load Case 1	NP+EW+WI+FW+BW
Load Case 2	NP+EW+EE+FS+BS
Load Case 3	NP+OW+WI+FW+BW
Load Case 4	NP+OW+EQ+FS+BS
Load Case 5	NP+HW+HI
Load Case 6	NP+HW+HE

## N2 Pulsation damper second stage suction

C220006CLC011

## Static Calculation

PV Elite 24 SP1 Licensee: PPV-Engineering B.V.

FileName : 2nd-stage Suction\_LI4735

Input Echo:

-----  
Step: 1 9:05am Jun 21, 2022

Load Case 7	IP+OW+WI+FW+BW
Load Case 8	IP+OW+EQ+FS+BS
Load Case 9	EP+OW+WI+FW+BW
Load Case 10	EP+OW+EQ+FS+BS
Load Case 11	HP+HW+HI
Load Case 12	HP+HW+HE
Load Case 13	IP+WE+EW
Load Case 14	IP+WF+CW
Load Case 15	IP+VO+OW
Load Case 16	IP+VE+EW
Load Case 17	NP+VO+OW
Load Case 18	FS+BS+IP+OW
Load Case 19	FS+BS+EP+OW

Wind Design Code No Wind Loads

Seismic Design Code No Seismic

Design Pressure + Static Head	Y
Consider MAP New and Cold in Noz. Design	N
Consider External Loads for Nozzle Des.	Y
Use ASME VIII-1 Appendix 1-9	N

Perform Blast Load Analysis	No
Material Database Year	Current w/Addenda or Code Year

**Configuration Directives:**

Do not use Nozzle MDMT Interpretation VIII-1 01-37	No
Use Table G instead of exact equation for "A"	Yes
Shell Head Joints are Tapered	Yes
Compute "K" in corroded condition	Yes
Use Code Case 2286	No
Use the MAWP to compute the MDMT	Yes
For thickness ratios $\leq 0.35$ , MDMT will be -155F (-104C)	Yes
For PWHT & P1 Materials the MDMT can be $< -55F (-48C)$	No
Using Metric Material Databases, ASME II D	No
Calculate B31.3 type stress for Nozzles with Loads	Yes
Reduce the MDMT due to lower membrane stress	Yes
Consider Longitudinal Stress in MDMT Calculations	Yes

**Complete Listing of Vessel Elements and Details:**

Element From Node	10
Element To Node	20
Element Type	Elliptical
Description	Left Head
Distance "FROM" to "TO"	63.36 mm
Element Outside Diameter	273 mm
Element Thickness	9.27 mm
Internal Corrosion Allowance	3 mm
Nominal Thickness	9.27 mm
External Corrosion Allowance	0 mm
Design Internal Pressure	2.4 MPa
Design Temperature Internal Pressure	85 °C
Design External Pressure	0 MPa
Design Temperature External Pressure	85 °C
Effective Diameter Multiplier	1.2

N2 Pulsation damper second stage suction  
C220006CLC011

Static Calculation

PV Elite 24 SP1 Licensee: PPV-Engineering B.V.

FileName : 2nd-stage Suction\_LI4735

Input Echo: Step: 1 9:05am Jun 21,2022

Material Name	SA-234 WPB	
Allowable Stress, Ambient	117.9	MPa
Allowable Stress, Operating	117.9	MPa
Allowable Stress, Hydrotest	153.28	MPa
Material Density	0.00775	kg/cm <sup>3</sup>
P Number Thickness	30.988	mm
Yield Stress, Operating	222.99	MPa
UCS-66 Chart Curve Designation	B	
External Pressure Chart Name	CS-2	
UNS Number	K03006	
Product Form	Smls. & wld. fittings	
Efficiency, Longitudinal Seam	0.85	
Efficiency, Circumferential Seam	0.85	
Elliptical Head Factor	2.0	
Weld is pre-Heated	No	

Element From Node	20	
Element To Node	30	
Element Type	Cylinder	
Description	Cylinder	
Distance "FROM" to "TO"	552	mm
Element Outside Diameter	273	mm
Element Thickness	8.11	mm
Internal Corrosion Allowance	3	mm
Nominal Thickness	9.27	mm
External Corrosion Allowance	0	mm
Design Internal Pressure	2.4	MPa
Design Temperature Internal Pressure	85	°C
Design External Pressure	0	MPa
Design Temperature External Pressure	85	°C
Effective Diameter Multiplier	1.2	
Material Name	SA-106 B	
Allowable Stress, Ambient	117.9	MPa
Allowable Stress, Operating	117.9	MPa
Allowable Stress, Hydrotest	153.28	MPa
Material Density	0.00775	kg/cm <sup>3</sup>
P Number Thickness	30.988	mm
Yield Stress, Operating	222.99	MPa
UCS-66 Chart Curve Designation	B	
External Pressure Chart Name	CS-2	
UNS Number	K03006	
Product Form	Smls. pipe	
Efficiency, Longitudinal Seam	0.85	
Efficiency, Circumferential Seam	0.85	
Weld is pre-Heated	No	

Element From Node	20	
Detail Type	Nozzle	
Detail ID	N2	
Dist. from "FROM" Node / Offset dist	456	mm
Nozzle Diameter	50	mm
Nozzle Schedule	160	
Nozzle Class	300	
Layout Angle	270.0	
Blind Flange (Y/N)	N	
Weight of Nozzle ( Used if > 0 )	0	N
Grade of Attached Flange	GR 1.1	

N2 Pulsation damper second stage suction  
 C220006CLC011

Static Calculation

PV Elite 24 SP1 Licensee: PPV-Engineering B.V.

FileName : 2nd-stage Suction\_LI4735

Input Echo: Step: 1 9:05am Jun 21,2022

```

Nozzle Matl SA-106 B

Element From Node 20
Detail Type Nozzle
Detail ID N3
Dist. from "FROM" Node / Offset dist 276 mm
Nozzle Diameter 38.1 mm
Nozzle Schedule None
Nozzle Class None
Layout Angle 270.0
Blind Flange (Y/N) N
Weight of Nozzle ( Used if > 0 ) 0 N
Grade of Attached Flange None
Nozzle Matl SA-106 B

Element From Node 20
Detail Type Nozzle
Detail ID N1
Dist. from "FROM" Node / Offset dist 156 mm
Nozzle Diameter 50 mm
Nozzle Schedule 160
Nozzle Class 300
Layout Angle 0.0
Blind Flange (Y/N) N
Weight of Nozzle ( Used if > 0 ) 0 N
Grade of Attached Flange None
Nozzle Matl SA-106 B
  
```

```

-----
Element From Node 30
Element To Node 40
Element Type Elliptical
Description Right Cap
Distance "FROM" to "TO" 63.36 mm
Element Outside Diameter 273 mm
Element Thickness 9.27 mm
Internal Corrosion Allowance 3 mm
Nominal Thickness 9.27 mm
External Corrosion Allowance 0 mm
Design Internal Pressure 2.4 MPa
Design Temperature Internal Pressure 85 °C
Design External Pressure 0 MPa
Design Temperature External Pressure 85 °C
Effective Diameter Multiplier 1.2
Material Name SA-234 WPB
  Allowable Stress, Ambient 117.9 MPa
  Allowable Stress, Operating 117.9 MPa
  Allowable Stress, Hydrotest 153.28 MPa
  Material Density 0.00775 kg/cm³
  P Number Thickness 30.988 mm
  Yield Stress, Operating 222.99 MPa
  UCS-66 Chart Curve Designation B
  External Pressure Chart Name CS-2
  UNS Number K03006
  Product Form Smls. & wld. fittings
Efficiency, Longitudinal Seam 0.85
Efficiency, Circumferential Seam 0.85
Elliptical Head Factor 2.0
  
```

N2 Pulsation damper second stage suction

C220006CLC011

Static Calculation

PV Elite 24 SP1 Licensee: PPV-Engineering B.V.

FileName : 2nd-stage Suction\_LI4735 -----

Input Echo: Step: 1 9:05am Jun 21,2022

Weld is pre-Heated

No

PV Elite is a trademark of Hexagon AB, 2022, All rights reserved.

N2 Pulsation damper second stage suction  
C220006CLC011

Static Calculation

PV Elite 24 SP1 Licensee: PPV-Engineering B.V.

FileName : 2nd-stage Suction\_LI4735

Internal Pressure Calculations: Step: 3 9:05am Jun 21, 2022

**Internal Pressure Results Summary:**

**Element Thickness, Pressure, Diameter and Allowable Stress :**

From	To	Int. Press + Liq. Hd MPa	Nominal Thickness mm	Total Corr Allowance mm	Element Diameter mm	Allowable Stress(SE) MPa
Left Head		2.4	9.27	3	273	100.22
Cylinder		2.4	9.27	3	273	100.22
Right Cap		2.4	9.27	3	273	100.22

**Element Required Thickness and MAWP :**

From	To	Design Pressure MPa	M.A.W.P. Corroded MPa	M.A.P. New & Cold MPa	Minimum Thickness mm	Required Thickness mm
Left Head		2.4	4.69	7.249	9.27	6.10705
Cylinder		2.4	3.809	6.099	8.11	6.23783
Right Cap		2.4	4.69	7.249	9.27	6.10705
Minimum			3.809	5.11		

Note : The M.A.P.(NC) is Governed by a Flange !

MAWP: 3.809 MPa, limited by: Cylinder.

Elements Suitable for Design Internal Pressure.

**Internal Pressure Calculation Results:**

**ASME Code, Section VIII Division 1, 2021**

**Elliptical Head From 10 To 20 SA-234 WPB , UCS-66 Crv. B at 85 °C**

Left Head

Longitudinal Joint: User Defined

Material UNS Number: K03006

Required Thickness due to Internal Pressure [tr]:

$$\begin{aligned}
 &= (P \cdot D_o \cdot K_{cor}) / (2 \cdot S \cdot E + 2 \cdot P \cdot (K_{cor} - 0.1)) \text{ per Appendix 1-4 (c)} \\
 &= (2.4 \cdot 273 \cdot 0.97) / (2 \cdot 117.9 \cdot 0.85 + 2 \cdot 2.4 \cdot (0.97 - 0.1)) \\
 &= 3.1071 + 3.0000 = 6.1071 \text{ mm}
 \end{aligned}$$

Max. Allowable Working Pressure at given Thickness, corroded [MAWP]:

$$\begin{aligned}
 &= (2 \cdot S \cdot E \cdot t) / (K_{cor} \cdot D_o - 2 \cdot t \cdot (K_{cor} - 0.1)) \text{ per Appendix 1-4 (c)} \\
 &= (2 \cdot 117.9 \cdot 0.85 \cdot 6.27) / (0.97 \cdot 273 - 2 \cdot 6.27 \cdot (0.97 - 0.1)) \\
 &= 4.948 \text{ MPa}
 \end{aligned}$$

Maximum Allowable Pressure, New and Cold [MAPNC]:

$$\begin{aligned}
 &= (2 \cdot S \cdot E \cdot t) / (K \cdot D_o - 2 \cdot t \cdot (K - 0.1)) \text{ per Appendix 1-4 (c)} \\
 &= (2 \cdot 117.9 \cdot 0.85 \cdot 9.27) / (1 \cdot 273 - 2 \cdot 9.27 \cdot (1 - 0.1)) \\
 &= 7.249 \text{ MPa}
 \end{aligned}$$

N2 Pulsation damper second stage suction  
C220006CLC011

Static Calculation

PV Elite 24 SP1 Licensee: PPV-Engineering B.V.

FileName : 2nd-stage Suction\_LI4735

Internal Pressure Calculations: Step: 3 9:05am Jun 21, 2022

Actual stress at given pressure and thickness, corroded [Sact]:

$$= (P*(Kcor*Do-2*t*(Kcor-0.1)))/(2*E*t)$$

$$= (2.4*(0.97*273-2*6.27*(0.97-0.1)))/(2*0.85*6.27)$$

$$= 57.187 \text{ MPa}$$

Straight Flange Required Thickness:

$$= (P*Ro)/(S*E+0.4*P) + ca \text{ per Appendix 1-1 (a)(1)}$$

$$= (2.4*136.5)/(117.9*0.85+0.4*2.4)+3$$

$$= 6.238 \text{ mm}$$

Straight Flange Maximum Allowable Working Pressure:

$$= (S*E*t)/(Ro-0.4*t) \text{ per Appendix 1-1 (a)(1)}$$

$$= (117.9 * 0.85 * 6.27)/(136.5 - 0.4 * 6.27)$$

$$= 4.69 \text{ MPa}$$

Factor K, corroded condition [Kcor]:

$$= (2 + (\text{Inside Diameter}/(2 * \text{Inside Head Depth}))^2)/6$$

$$= (2 + (260.5/(2 * 66.61))^2)/6$$

$$= 0.970315$$

**MDMT Calculations in the Knuckle Portion:**

Govrn. thk, tg = 9.27, tr = 4.873, c = 3 mm, E\* = 0.85

Thickness Ratio = tr \* E\*/(tg - c) = 0.661, Temp. Reduction = 19 °C

Min Metal Temp. w/o impact per UCS-66, Curve B -29 °C  
Min Metal Temp. at Required thickness (UCS 66.1) -48 °C

**MDMT Calculations in the Head Straight Flange:**

Govrn. thk, tg = 9.27, tr = 5.11, c = 3 mm, E\* = 0.85

Thickness Ratio = tr \* E\*/(tg - c) = 0.693, Temp. Reduction = 17 °C

Min Metal Temp. w/o impact per UCS-66, Curve B -29 °C  
Min Metal Temp. at Required thickness (UCS 66.1) -46 °C

**Cylindrical Shell From 20 To 30 SA-106 B , UCS-66 Crv. B at 85 °C**

Cylinder

Longitudinal Joint: Spot Radiography per UW-11(b) Type 1

Material UNS Number: K03006

Required Thickness due to Internal Pressure [tr]:

$$= (P*Ro) / (S*E+0.4*P) \text{ per Appendix 1-1 (a)(1)}$$

$$= (2.4*136.5)/(117.9*0.85+0.4*2.4)$$

$$= 3.2378 + 3.0000 = 6.2378 \text{ mm}$$

Max. Allowable Working Pressure at given Thickness, corroded [MAWP]:

$$= (S*E*t)/(Ro-0.4*t) \text{ per Appendix 1-1 (a)(1)}$$

$$= (117.9*0.85*5.11)/(136.5-0.4*5.11)$$

$$= 3.809 \text{ MPa}$$

Maximum Allowable Pressure, New and Cold [MAPNC]:

$$= (S*E*t)/(Ro-0.4*t) \text{ per Appendix 1-1 (a)(1)}$$

$$= (117.9*0.85*8.11)/(136.5-0.4*8.11)$$

$$= 6.099 \text{ MPa}$$

N2 Pulsation damper second stage suction  
C220006CLC011

Static Calculation

PV Elite 24 SP1 Licensee: PPV-Engineering B.V.

FileName : 2nd-stage Suction\_LI4735

Internal Pressure Calculations: Step: 3 9:05am Jun 21, 2022

Actual stress at given pressure and thickness, corroded [Sact]:

$$= (P \cdot (Ro - 0.4 \cdot t)) / (E \cdot t)$$

$$= (2.4 \cdot ((136.5 - 0.4 \cdot 5.11)) / (0.85 \cdot 5.11))$$

$$= 74.294 \text{ MPa}$$

**Minimum Design Metal Temperature Results:**

Govrn. thk, tg = 8.11, tr = 2.478, c = 3 mm, E\* = 0.85

Thickness Ratio = tr \* E\* / (tg - c) = 0.412, Temp. Reduction = 48 °C

Min Metal Temp. w/o impact per UCS-66, Curve B -29 °C

Min Metal Temp. at Required thickness (UCS 66.1) -48 °C

**Elliptical Head From 30 To 40 SA-234 WPB, UCS-66 Crv. B at 85 °C**

Right Cap

Longitudinal Joint: User Defined

Material UNS Number: K03006

Required Thickness due to Internal Pressure [tr]:

$$= (P \cdot Do \cdot K_{cor}) / (2 \cdot S \cdot E + 2 \cdot P \cdot (K_{cor} - 0.1)) \text{ per Appendix 1-4 (c)}$$

$$= (2.4 \cdot 273 \cdot 0.97) / (2 \cdot 117.9 \cdot 0.85 + 2 \cdot 2.4 \cdot (0.97 - 0.1))$$

$$= 3.1071 + 3.0000 = 6.1071 \text{ mm}$$

Max. Allowable Working Pressure at given Thickness, corroded [MAWP]:

$$= (2 \cdot S \cdot E \cdot t) / (K_{cor} \cdot Do - 2 \cdot t \cdot (K_{cor} - 0.1)) \text{ per Appendix 1-4 (c)}$$

$$= (2 \cdot 117.9 \cdot 0.85 \cdot 6.27) / (0.97 \cdot 273 - 2 \cdot 6.27 \cdot (0.97 - 0.1))$$

$$= 4.948 \text{ MPa}$$

Maximum Allowable Pressure, New and Cold [MAPNC]:

$$= (2 \cdot S \cdot E \cdot t) / (K \cdot Do - 2 \cdot t \cdot (K - 0.1)) \text{ per Appendix 1-4 (c)}$$

$$= (2 \cdot 117.9 \cdot 0.85 \cdot 9.27) / (1 \cdot 273 - 2 \cdot 9.27 \cdot (1 - 0.1))$$

$$= 7.249 \text{ MPa}$$

Actual stress at given pressure and thickness, corroded [Sact]:

$$= (P \cdot (K_{cor} \cdot Do - 2 \cdot t \cdot (K_{cor} - 0.1))) / (2 \cdot E \cdot t)$$

$$= (2.4 \cdot (0.97 \cdot 273 - 2 \cdot 6.27 \cdot (0.97 - 0.1))) / (2 \cdot 0.85 \cdot 6.27)$$

$$= 57.187 \text{ MPa}$$

Straight Flange Required Thickness:

$$= (P \cdot Ro) / (S \cdot E + 0.4 \cdot P) + ca \text{ per Appendix 1-1 (a)(1)}$$

$$= (2.4 \cdot 136.5) / (117.9 \cdot 0.85 + 0.4 \cdot 2.4) + 3$$

$$= 6.238 \text{ mm}$$

Straight Flange Maximum Allowable Working Pressure:

$$= (S \cdot E \cdot t) / (Ro - 0.4 \cdot t) \text{ per Appendix 1-1 (a)(1)}$$

$$= (117.9 \cdot 0.85 \cdot 6.27) / (136.5 - 0.4 \cdot 6.27)$$

$$= 4.69 \text{ MPa}$$

Factor K, corroded condition [Kcor]:

$$= (2 + (\text{Inside Diameter} / (2 \cdot \text{Inside Head Depth})))^2 / 6$$

$$= (2 + (260.5 / (2 \cdot 66.61)))^2 / 6$$

$$= 0.970315$$

**MDMT Calculations in the Knuckle Portion:**

Govrn. thk, tg = 9.27, tr = 4.873, c = 3 mm, E\* = 0.85

N2 Pulsation damper second stage suction  
C220006CLC011

### Static Calculation

PV Elite 24 SP1 Licensee: PPV-Engineering B.V.

FileName : 2nd-stage Suction\_LI4735

Internal Pressure Calculations: Step: 3 9:05am Jun 21, 2022

Thickness Ratio =  $tr * E^*/(tg - c) = 0.661$ , Temp. Reduction = 19 °C

Min Metal Temp. w/o impact per UCS-66, Curve B -29 °C

Min Metal Temp. at Required thickness (UCS 66.1) -48 °C

### MDMT Calculations in the Head Straight Flange:

Govrn. thk,  $tg = 9.27$ ,  $tr = 5.11$ ,  $c = 3$  mm,  $E^* = 0.85$

Thickness Ratio =  $tr * E^*/(tg - c) = 0.693$ , Temp. Reduction = 17 °C

Min Metal Temp. w/o impact per UCS-66, Curve B -29 °C

Min Metal Temp. at Required thickness (UCS 66.1) -46 °C

Note: Heads and Shells Exempted to -20F (-29C) by paragraph UG-20F

### Hydrostatic Test Pressure Results:

Pressure per UG99b	= 1.30 * M.A.W.P. * Sa/S	4.951 MPa
Pressure per UG99b[35]	= 1.30 * Design Pres * Sa/S	3.120 MPa
Pressure per UG99c	= 1.30 * M.A.P. - Head(Hyd)	6.643 MPa
Pressure per UG100	= 1.10 * M.A.W.P. * Sa/S	4.190 MPa
Pressure per PED	= max(1.43*DP, 1.25*DP*ratio)	3.432 MPa
Pressure per App 27-4	= M.A.W.P.	3.809 MPa

User Defined Hydrostatic Test Pressure at High Point 6.640 MPa

### Horizontal Test performed per: User Hydro Pressure

Please note that Nozzle, Shell, Head, Flange, etc MAWPs are all considered when determining the hydrotest pressure for those test types that are based on the MAWP of the vessel.

### Stresses on Elements due to Test Pressure (MPa):

From To	Stress	Allowable	Ratio	Pressure
Left Head	108.0	153.3	0.705	6.64
Cylinder	128.4	153.3	0.838	6.64
Right Cap	108.0	153.3	0.705	6.64

### Stress ratios for Nozzle and Pad Materials (MPa):

Description	Pad/Nozzle	Ambient	Operating	Ratio
N2	Nozzle	117.90	117.90	1.000
N3	Nozzle	117.90	117.90	1.000
N1	Nozzle	117.90	117.90	1.000
Minimum				1.000

### Stress ratios for Pressurized Vessel Elements (MPa):

Description	Ambient	Operating	Ratio
Left Head	117.90	117.90	1.000
Cylinder	117.90	117.90	1.000
Right Cap	117.90	117.90	1.000

N2 Pulsation damper second stage suction

C220006CLC011

Static Calculation

PV Elite 24 SP1 Licensee: PPV-Engineering B.V.

FileName : 2nd-stage Suction\_LI4735 -----

Internal Pressure Calculations: Step: 3 9:05am Jun 21,2022

-----  
 Minimum 1.000

**Hoop Stress in Nozzle Wall during Pressure Test (MPa):**

Description	Ambient	Operating	Ratio
N2	20.27	153.28	0.132
N3	12.44	153.28	0.081
N1	20.27	153.28	0.132

Elements Suitable for Test Pressure.

**PV Elite is a trademark of Hexagon AB, 2022, All rights reserved.**

N2 Pulsation damper second stage suction

C220006CLC011

Static Calculation

PV Elite 24 SP1 Licensee: PPV-Engineering B.V.

FileName : 2nd-stage Suction\_LI4735

Nozzle Flange MAWP: Step: 6 9:05am Jun 21,2022

**Nozzle Flange MAWP Results: (MPa & °C)**

Nozzle Description	Flange Rating		Design	Class	Grade/Group	Equiv. Press	Max Pressure		
	Op.	Ambient	Temp				UG-44(b)	50%	DNV
N2	4.77	5.11	85	300	GR 1.1	...	...	...	...
Min Rating	4.765	5.110 MPa [for Core Elements]					...	...	...

Pressure Ratings are per ASME B16.5 2017 Metric Edition

PV Elite is a trademark of Hexagon AB, 2022, All rights reserved.

N2 Pulsation damper second stage suction  
C220006CLC011

Static Calculation

PV Elite 24 SP1 Licensee: PPV-Engineering B.V.

FileName : 2nd-stage Suction\_LI4735

Nozzle Calcs.: N2

-----  
Noz1: 13 9:05am Jun 21,2022

**Input, Nozzle Desc: N2**

**From: 20**

Pressure for Reinforcement Calculations	P	2.4000	MPa
Temperature for Internal Pressure	Temp	85	°C
Parent Material		SA-106 B	
Parent Allowable Stress at Temperature	Sv	117.90	MPa
Parent Allowable Stress At Ambient	Sva	117.90	MPa
Inside Diameter of Cylindrical Shell	D	254.46	mm
Shell Finished (Minimum) Thickness	t	8.1100	mm
Shell Internal Corrosion Allowance	c	3.0000	mm
Shell External Corrosion Allowance	co	0.0000	mm
Distance from Bottom/Left Tangent		519.36	mm
User Entered Minimum Design Metal Temperature		-28.89	°C

**Type of Element Connected to the Parent : Nozzle**

Material		SA-106 B	
Material UNS Number		K03006	
Material Specification/Type		Smls. pipe	
Allowable Stress at Temperature	Sn	117.90	MPa
Allowable Stress At Ambient	Sna	117.90	MPa
Diameter Basis (for tr calc only)		Outside	
Layout Angle		270.00	deg
Diameter		50.0000	mm
Size and Thickness Basis		Nominal	
Nominal Thickness		160	
Flange Material		SA-105	
Flange Type		Weld Neck Flange	
Corrosion Allowance	can	3.0000	mm
Joint Efficiency of Shell Seam at Nozzle	E1	1.00	
Joint Efficiency of Nozzle Neck	En	1.00	
Outside Projection	ho	68.0000	mm
Weld leg size between Nozzle and Pad/Shell	Wo	6.0000	mm
Groove weld depth between Nozzle and Vessel Wgnv		8.3400	mm
Flange Class		300	
Flange Grade		GR 1.1	

The Pressure Design option was Design Pressure + static head.

**Nozzle Sketch (may not represent actual weld type/configuration)**

N2 Pulsation damper second stage suction  
C220006CLC011

Static Calculation

PV Elite 24 SP1 Licensee: PPV-Engineering B.V.

FileName : 2nd-stage Suction\_LI4735

Nozzle Calcs.: N2

-----  
Nozl: 13 9:05am Jun 21,2022

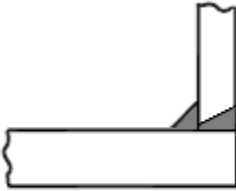

### Abutting/Set-on Nozzle No Pad

### Reinforcement CALCULATION, Description: N2

ASME Code, Section VIII, Div. 1, 2021, UG-37 to UG-45

Actual Outside Diameter Used in Calculation	60.325 mm.
Actual Thickness Used in Calculation	8.738 mm

Nozzle input data check completed without errors.

Reqd thk per UG-37(a) of Cylindrical Shell, tr [Int. Press]

$$= P \cdot R / (S_v \cdot E - 0.6 \cdot P) \text{ per UG-27 (c)(1)}$$

$$= 2.4 \cdot 130.2 / (117.9 \cdot 1 - 0.6 \cdot 2.4)$$

$$= 2.6837 \text{ mm}$$

Reqd thk per UG-37(a) of Nozzle Wall, trn [Int. Press]

$$= P \cdot R_o / (S_n \cdot E + 0.4 \cdot P) \text{ per Appendix 1-1 (a)(1)}$$

$$= 2.4 \cdot 30.16 / (117.9 \cdot 1 + 0.4 \cdot 2.4)$$

$$= 0.6090 \text{ mm}$$

### UG-40, Limits of Reinforcement : [Internal Pressure]

Parallel to Vessel Wall (Diameter Limit)	D1	97.6996 mm
Parallel to Vessel Wall, opening length	d	48.8498 mm
Normal to Vessel Wall (Thickness Limit), no pad	Tlnp	12.7750 mm

*Taking a UG-36(c)(3)(a) exemption for nozzle: N2.*

*This calculation is valid for nozzles that meet all the requirements of paragraph UG-36. Please check the Code carefully, especially for nozzles that are not isolated or do not meet Code spacing requirements. To force the computation of areas for small nozzles go to Tools->Configuration and check the box to force the UG-37 small nozzle area calculation.*

### UG-45 Minimum Nozzle Neck Thickness Requirement: [Int. Press.]

Wall Thickness for Internal/External pressures	ta = 3.6090 mm
Wall Thickness per UG16(b),	tr16b = 4.5000 mm
Wall Thickness, shell/head, internal pressure	trb1 = 5.6837 mm
Wall Thickness	tb1 = max(trb1, tr16b) = 5.6837 mm
Wall Thickness	tb2 = max(trb2, tr16b) = 4.5000 mm
Wall Thickness per table UG-45	tb3 = 6.4200 mm

Determine Nozzle Thickness candidate [tb]:

$$= \min[ tb3, \max( tb1, tb2 ) ]$$

$$= \min[ 6.42, \max( 5.684, 4.5 ) ]$$

$$= 5.6837 \text{ mm}$$

Minimum Wall Thickness of Nozzle Necks [tUG-45]:

$$= \max( ta, tb )$$

N2 Pulsation damper second stage suction  
C220006CLC011

Static Calculation

PV Elite 24 SP1 Licensee: PPV-Engineering B.V.

FileName : 2nd-stage Suction\_LI4735

Nozzle Calcs.: N2

Nozl: 13 9:05am Jun 21, 2022

$$= \max( 3.609, 5.684 )$$

$$= 5.6837 \text{ mm}$$

Available Nozzle Neck Thickness =  $0.875 * 8.738 = 7.645 \text{ mm}$  --> OK

### Nozzle Junction Minimum Design Metal Temperature (MDMT) Calculations:

#### Nozzle Neck to Flange Weld, min( Curve:B, Curve:A)

Govrn. thk, tg = 7.645, tr = 0.609, c = 3 mm, E\* = 1  
Thickness Ratio =  $tr * E*/(tg - c) = 0.131$ , Temp. Reduction = 78 °C

Min Metal Temp. w/o impact per UCS-66, Curve A	-8 °C
Min Metal Temp. at Required thickness (UCS 66.1)	-104 °C
Min Metal Temp. w/o impact per UG-20(f)	-29 °C

#### Nozzle-Shell/Head Weld (UCS-66(a)1(b)), Curve: B

Govrn. thk, tg = 7.645, tr = 0.609, c = 3 mm, E\* = 1  
Thickness Ratio =  $tr * E*/(tg - c) = 0.131$ , Temp. Reduction = 78 °C

Min Metal Temp. w/o impact per UCS-66, Curve B	-29 °C
Min Metal Temp. at Required thickness (UCS 66.1)	-104 °C

Gov. MDMT of the nozzle to shell joint welded assembly : -104 °C

#### Flange MDMT including Temperature reduction per UCS-66.1:

Unadjusted MDMT of ASME B16.5/47 flanges per UCS-66(c)	-18 °C
Flange MDMT with Temp reduction per UCS-66(b)(1)(-b)	-48 °C

Where the Stress Reduction Ratio per UCS-66(b)(1)(-b) is :  
Design Pressure/Ambient Rating =  $2.40/5.11 = 0.470$

#### Weld Size Calculations, Description: N2

Intermediate Calc. for nozzle/shell Welds Tmin 5.7376 mm

#### Results Per UW-16.1:

	Required Thickness	Actual Thickness
Nozzle Weld	$4.0163 = 0.7 * t_{min}$	$4.2420 = 0.7 * W_o$ mm

Skipping the nozzle attachment weld strength calculations. Per UW-15(b)(2) the nozzles exempted by UG-36(c)(3)(a) (small nozzles) do not require a weld strength check.

#### Maximum Allowable Pressure for this Nozzle at this Location:

Converged Maximum Allowable Pressure in the Operating case: 3.809 MPa

Note: The MAWP of this junction was limited by the parent Shell/Head.

The Drop for this Nozzle is : 3.6270 mm

The Cut Length for this Nozzle is, Drop + Ho + H + T : 79.7370 mm

PV Elite is a trademark of Hexagon AB, 2022, All rights reserved.

N2 Pulsation damper second stage suction  
C220006CLC011

Static Calculation

PV Elite 24 SP1 Licensee: PPV-Engineering B.V.

FileName : 2nd-stage Suction\_LI4735

Nozzle Calcs.: N3

-----  
Noz1: 14 9:05am Jun 21,2022

**Input, Nozzle Desc: N3**

**From: 20**

Pressure for Reinforcement Calculations	P	2.4000	MPa
Temperature for Internal Pressure	Temp	85	°C
Parent Material		SA-106 B	
Parent Allowable Stress at Temperature	Sv	117.90	MPa
Parent Allowable Stress At Ambient	Sva	117.90	MPa
Inside Diameter of Cylindrical Shell	D	254.46	mm
Shell Finished (Minimum) Thickness	t	8.1100	mm
Shell Internal Corrosion Allowance	c	3.0000	mm
Shell External Corrosion Allowance	co	0.0000	mm
Distance from Bottom/Left Tangent		339.36	mm
User Entered Minimum Design Metal Temperature		-28.89	°C

**Type of Element Connected to the Parent : Nozzle**

Material		SA-106 B	
Material UNS Number		K03006	
Material Specification/Type		Smls. pipe	
Allowable Stress at Temperature	Sn	117.90	MPa
Allowable Stress At Ambient	Sna	117.90	MPa
Diameter Basis (for tr calc only)		Outside	
Layout Angle		270.00	deg
Diameter		38.1000	mm
Size and Thickness Basis		Actual	
Actual Thickness	tn	8.3820	mm
Corrosion Allowance	can	3.0000	mm
Joint Efficiency of Shell Seam at Nozzle	E1	1.00	
Joint Efficiency of Nozzle Neck	En	1.00	
Outside Projection	ho	47.6250	mm
Weld leg size between Nozzle and Pad/Shell	Wo	6.0000	mm
Groove weld depth between Nozzle and Vessel Wgnv		8.3400	mm

The Pressure Design option was Design Pressure + static head.

**Nozzle Sketch (may not represent actual weld type/configuration)**

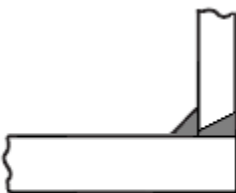

**Abutting/Set-on Nozzle No Pad**

N2 Pulsation damper second stage suction  
C220006CLC011

Static Calculation

PV Elite 24 SP1 Licensee: PPV-Engineering B.V.

FileName : 2nd-stage Suction\_LI4735

Nozzle Calcs.: N3

-----  
Nozl: 14 9:05am Jun 21, 2022

### Reinforcement CALCULATION, Description: N3

ASME Code, Section VIII, Div. 1, 2021, UG-37 to UG-45

Actual Outside Diameter Used in Calculation	38.100 mm.
Actual Thickness Used in Calculation	8.382 mm

Nozzle input data check completed without errors.

Reqd thk per UG-37(a) of Cylindrical Shell, tr [Int. Press]

$$= P \cdot R / (S_v \cdot E - 0.6 \cdot P) \text{ per UG-27 (c)(1)}$$

$$= 2.4 \cdot 130.2 / (117.9 \cdot 1 - 0.6 \cdot 2.4)$$

$$= 2.6837 \text{ mm}$$

Reqd thk per UG-37(a) of Nozzle Wall, trn [Int. Press]

$$= P \cdot R_o / (S_n \cdot E + 0.4 \cdot P) \text{ per Appendix 1-1 (a)(1)}$$

$$= 2.4 \cdot 19.05 / (117.9 \cdot 1 + 0.4 \cdot 2.4)$$

$$= 0.3846 \text{ mm}$$

### UG-40, Limits of Reinforcement : [Internal Pressure]

Parallel to Vessel Wall (Diameter Limit)	D1	54.6720 mm
Parallel to Vessel Wall, opening length	d	27.3360 mm
Normal to Vessel Wall (Thickness Limit), no pad	Tlnp	12.7750 mm

*Taking a UG-36(c)(3)(a) exemption for nozzle: N3.*

*This calculation is valid for nozzles that meet all the requirements of paragraph UG-36. Please check the Code carefully, especially for nozzles that are not isolated or do not meet Code spacing requirements. To force the computation of areas for small nozzles go to Tools->Configuration and check the box to force the UG-37 small nozzle area calculation.*

### UG-45 Minimum Nozzle Neck Thickness Requirement: [Int. Press.]

Wall Thickness for Internal/External pressures	ta = 3.3846 mm
Wall Thickness per UG16(b),	tr16b = 4.5000 mm
Wall Thickness, shell/head, internal pressure	trb1 = 5.6837 mm
Wall Thickness	tb1 = max(trb1, tr16b) = 5.6837 mm
Wall Thickness	tb2 = max(trb2, tr16b) = 4.5000 mm
Wall Thickness per table UG-45	tb3 = 6.1200 mm

Determine Nozzle Thickness candidate [tb]:

$$= \min[ tb3, \max( tb1, tb2 ) ]$$

$$= \min[ 6.12, \max( 5.684, 4.5 ) ]$$

$$= 5.6837 \text{ mm}$$

Minimum Wall Thickness of Nozzle Necks [tUG-45]:

$$= \max( ta, tb )$$

$$= \max( 3.385, 5.684 )$$

$$= 5.6837 \text{ mm}$$

Available Nozzle Neck Thickness = 8.3820 mm --> OK

### Nozzle Junction Minimum Design Metal Temperature (MDMT) Calculations:

#### Nozzle-Shell/Head Weld (UCS-66(a)1(b)), Curve: B

-----  
Govrn. thk, tg = 8.11, tr = 2.684, c = 3 mm, E\* = 1

Thickness Ratio = tr \* E\*/(tg - c) = 0.525, Temp. Reduction = 29 °C

N2 Pulsation damper second stage suction

C220006CLC011

Static Calculation

PV Elite 24 SP1 Licensee: PPV-Engineering B.V.

FileName : 2nd-stage Suction\_LI4735

Nozzle Calcs.: N3

Nozl: 14 9:05am Jun 21,2022

Min Metal Temp. w/o impact per UCS-66, Curve B -29 °C

Min Metal Temp. at Required thickness (UCS 66.1) -48 °C

Gov. MDMT of the nozzle to shell joint welded assembly : -48 °C

Weld Size Calculations, Description: N3

Intermediate Calc. for nozzle/shell Welds Tmin 5.3820 mm

**Results Per UW-16.1:**

	Required Thickness	Actual Thickness
Nozzle Weld	3.7674 = 0.7 * tmin.	4.2420 = 0.7 * Wo mm

Skipping the nozzle attachment weld strength calculations. Per UW-15(b)(2) the nozzles exempted by UG-36(c)(3)(a) (small nozzles) do not require a weld strength check.

**Maximum Allowable Pressure for this Nozzle at this Location:**

Converged Maximum Allowable Pressure in the Operating case: 3.809 MPa

Note: The MAWP of this junction was limited by the parent Shell/Head.

The Drop for this Nozzle is : 1.4343 mm

The Cut Length for this Nozzle is, Drop + Ho + H + T : 57.1692 mm

**PV Elite is a trademark of Hexagon AB, 2022, All rights reserved.**

N2 Pulsation damper second stage suction  
 C220006CLC011

Static Calculation

PV Elite 24 SP1 Licensee: PPV-Engineering B.V.

FileName : 2nd-stage Suction\_LI4735

Nozzle Calcs.: N1 Nozl: 15 9:05am Jun 21,2022

**Input, Nozzle Desc: N1 From: 20**

Pressure for Reinforcement Calculations	P	2.4000	MPa
Temperature for Internal Pressure	Temp	85	°C
Parent Material		SA-106 B	
Parent Allowable Stress at Temperature	Sv	117.90	MPa
Parent Allowable Stress At Ambient	Sva	117.90	MPa
Inside Diameter of Cylindrical Shell	D	254.46	mm
Shell Finished (Minimum) Thickness	t	8.1100	mm
Shell Internal Corrosion Allowance	c	3.0000	mm
Shell External Corrosion Allowance	co	0.0000	mm
Distance from Bottom/Left Tangent		219.36	mm
User Entered Minimum Design Metal Temperature		-28.89	°C

**Type of Element Connected to the Parent : Nozzle**

Material		SA-106 B	
Material UNS Number		K03006	
Material Specification/Type		Smls. pipe	
Allowable Stress at Temperature	Sn	117.90	MPa
Allowable Stress At Ambient	Sna	117.90	MPa
Diameter Basis (for tr calc only)		Outside	
Layout Angle		0.00	deg
Diameter		50.0000	mm
Size and Thickness Basis		Nominal	
Nominal Thickness		160	
Flange Material		SA-105	
Flange Type		Weld Neck Flange	
Corrosion Allowance	can	3.0000	mm
Joint Efficiency of Shell Seam at Nozzle	E1	1.00	
Joint Efficiency of Nozzle Neck	En	1.00	
Outside Projection	ho	57.0000	mm
Weld leg size between Nozzle and Pad/Shell	Wo	6.0000	mm
Groove weld depth between Nozzle and Vessel Wgnv		8.3400	mm

The Pressure Design option was Design Pressure + static head.

**Nozzle Sketch (may not represent actual weld type/configuration)**

N2 Pulsation damper second stage suction  
C220006CLC011

Static Calculation

PV Elite 24 SP1 Licensee: PPV-Engineering B.V.

FileName : 2nd-stage Suction\_LI4735

Nozzle Calcs.: N1

-----  
Nozl: 15 9:05am Jun 21,2022

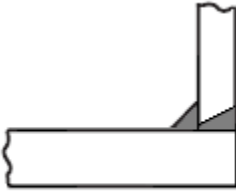

### Abutting/Set-on Nozzle No Pad

### Reinforcement CALCULATION, Description: N1

ASME Code, Section VIII, Div. 1, 2021, UG-37 to UG-45

Actual Outside Diameter Used in Calculation	60.325 mm.
Actual Thickness Used in Calculation	8.738 mm

Nozzle input data check completed without errors.

Reqd thk per UG-37(a) of Cylindrical Shell, tr [Int. Press]

$$= P \cdot R / (S_v \cdot E - 0.6 \cdot P) \text{ per UG-27 (c)(1)}$$

$$= 2.4 \cdot 130.2 / (117.9 \cdot 1 - 0.6 \cdot 2.4)$$

$$= 2.6837 \text{ mm}$$

Reqd thk per UG-37(a) of Nozzle Wall, trn [Int. Press]

$$= P \cdot R_o / (S_n \cdot E + 0.4 \cdot P) \text{ per Appendix 1-1 (a)(1)}$$

$$= 2.4 \cdot 30.16 / (117.9 \cdot 1 + 0.4 \cdot 2.4)$$

$$= 0.6090 \text{ mm}$$

### UG-40, Limits of Reinforcement : [Internal Pressure]

Parallel to Vessel Wall (Diameter Limit)	D1	97.6996 mm
Parallel to Vessel Wall, opening length	d	48.8498 mm
Normal to Vessel Wall (Thickness Limit), no pad	Tlnp	12.7750 mm

*Taking a UG-36(c)(3)(a) exemption for nozzle: N1.*

*This calculation is valid for nozzles that meet all the requirements of paragraph UG-36. Please check the Code carefully, especially for nozzles that are not isolated or do not meet Code spacing requirements. To force the computation of areas for small nozzles go to Tools->Configuration and check the box to force the UG-37 small nozzle area calculation.*

### UG-45 Minimum Nozzle Neck Thickness Requirement: [Int. Press.]

Wall Thickness for Internal/External pressures	ta = 3.6090 mm
Wall Thickness per UG16(b),	tr16b = 4.5000 mm
Wall Thickness, shell/head, internal pressure	trb1 = 5.6837 mm
Wall Thickness	tb1 = max(trb1, tr16b) = 5.6837 mm
Wall Thickness	tb2 = max(trb2, tr16b) = 4.5000 mm
Wall Thickness per table UG-45	tb3 = 6.4200 mm

Determine Nozzle Thickness candidate [tb]:

$$= \min[ tb3, \max( tb1, tb2 ) ]$$

$$= \min[ 6.42, \max( 5.684, 4.5 ) ]$$

$$= 5.6837 \text{ mm}$$

Minimum Wall Thickness of Nozzle Necks [tUG-45]:

$$= \max( ta, tb )$$

N2 Pulsation damper second stage suction

C220006CLC011

Static Calculation

PV Elite 24 SP1 Licensee: PPV-Engineering B.V.

FileName : 2nd-stage Suction\_LI4735

Nozzle Calcs.: N1

Noz1: 15 9:05am Jun 21, 2022

$$= \max( 3.609, 5.684 )$$

$$= 5.6837 \text{ mm}$$

Available Nozzle Neck Thickness =  $0.875 * 8.738 = 7.645 \text{ mm}$  --> OK

### Nozzle Junction Minimum Design Metal Temperature (MDMT) Calculations:

#### Nozzle Neck to Flange Weld, Curve: B

Govrn. thk, tg = 7.645, tr = 0.609, c = 3 mm, E\* = 1

Thickness Ratio =  $tr * E*/(tg - c) = 0.131$ , Temp. Reduction = 78 °C

Min Metal Temp. w/o impact per UCS-66, Curve B -29 °C

Min Metal Temp. at Required thickness (UCS 66.1) -104 °C

#### Nozzle-Shell/Head Weld (UCS-66(a)1(b)), Curve: B

Govrn. thk, tg = 7.645, tr = 0.609, c = 3 mm, E\* = 1

Thickness Ratio =  $tr * E*/(tg - c) = 0.131$ , Temp. Reduction = 78 °C

Min Metal Temp. w/o impact per UCS-66, Curve B -29 °C

Min Metal Temp. at Required thickness (UCS 66.1) -104 °C

Gov. MDMT of the nozzle to shell joint welded assembly : -104 °C

#### Weld Size Calculations, Description: N1

Intermediate Calc. for nozzle/shell Welds Tmin 5.7376 mm

#### Results Per UW-16.1:

	Required Thickness	Actual Thickness
Nozzle Weld	$4.0163 = 0.7 * t_{min}$	$4.2420 = 0.7 * W_o$ mm

Skipping the nozzle attachment weld strength calculations. Per UW-15(b)(2) the nozzles exempted by UG-36(c)(3)(a) (small nozzles) do not require a weld strength check.

#### Maximum Allowable Pressure for this Nozzle at this Location:

Converged Maximum Allowable Pressure in the Operating case: 3.809 MPa

Note: The MAWP of this junction was limited by the parent Shell/Head.

The Drop for this Nozzle is : 3.6270 mm

The Cut Length for this Nozzle is, Drop + Ho + H + T : 68.7370 mm

PV Elite is a trademark of Hexagon AB, 2022, All rights reserved.

# Report – 2nd-stage Suction\_LI4735 C220006CLC011

## **PV-Elite Calculation Summary**

Client: Airpack Nederland BV.  
Client location: Zierikzee  
Ref number client: 17811-OO-0702(KP)

### **PPV Engineering**

Author: H.Hoezen  
- Telephone: +31 (0)594 581010  
- E-mail: h.hoezen@ppv-engineering.nl

June 22, 2022  
Order number: P22-115-01  
Document number: 22-11501-C04  
Revision: 1

# Table of Contents

Cover Sheet .....	2
Vessel Design Summary: .....	3
Nozzle Summary: .....	5
Nozzle Schedule: .....	6
Bill of Material: .....	7
Input Echo: .....	8
Internal Pressure Calculations: .....	13
Element and Detail Weights: .....	18
Nozzle Flange MAWP: .....	20
Nozzle Calcs.: Noz N1 .....	21
Nozzle Calcs.: N2 .....	24
Nozzle Calcs.: N3 .....	27

N2 Pulsation damper second stage discharge  
C220006CLC012  
Static Calculation

**DESIGN CALCULATION**

*In Accordance with ASME Section VIII Division 1*

ASME Code Version : 2021

Analysis Performed by : PPV-Engineering B.V.

Job File : ...\\2nd-stage Discharge\_LI4736.pvdb

Date of Analysis : Jun 21,2022 9:13am

**PV Elite 24 SP1, March 2022**

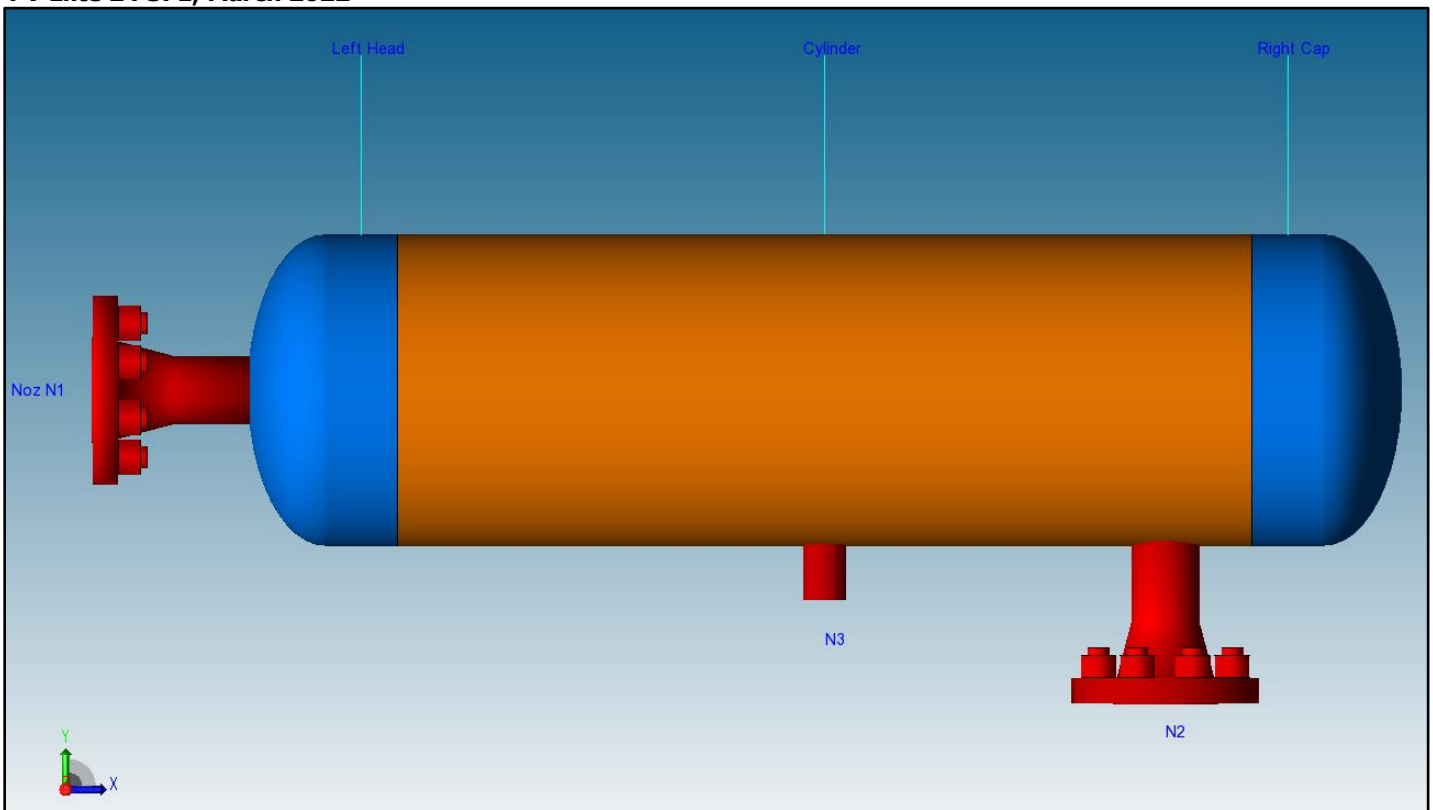

Static Calculation

PV Elite 24 SP1 Licensee: PPV-Engineering B.V.

FileName : 2nd-stage Discharge\_LI4736

Vessel Design Summary: Step: 15 9:13am Jun 21, 2022

**Vessel Design Summary:**

**ASME Code, Section VIII Division 1, 2021**

Diameter Spec : 273.000 mm OD	
Vessel Design Length, Tangent to Tangent	876.72 mm
Specified Datum Line Distance	63.36 mm
Internal Design Temperature	100 °C
Internal Design Pressure	2.500 MPa
External Design Temperature	100 °C
Maximum Allowable Working Pressure	3.809 MPa
Shop Test Pressure	6.640 MPa
Required Minimum Design Metal Temperature	-28.9 °C
Warmest Computed Minimum Design Metal Temperature	-46.0 °C
Wind Design Code	No Wind Loads
Earthquake Design Code	No Seismic

SHALL NOT BE LESS THAN 26 BARA. SHALL NOT BE LESS THAN PSV SET PRESSURE. PSV SET PRESSURE SHALL BE AT LEAST 10% GEATER THAN DISCHARGE PRESSURE.

**Materials of Construction:**

Component Type	Material	Class	Thickness	UNS #	Normalized	Impact Tested
Shell	SA-106 B	...	...	K03006	No	No
Head	SA-234 WPB	...	...	K03006	No	No
Nozzle	SA-106 B	...	...	K03006	No	No
Nozzle Flg	SA-105	...	...	K03504	Yes	No

Normalized is determined based on the UCS-66 material curve selection and Figure UCS-66.  
Impact Tested is based on material selection and material data properties.

**Element Pressures and MAWP (MPa & mm):**

Element Description or Type	Design Pressure + Stat. head	Ext. Press.	Element M.A.W.P	Total Corrosion Allowance	Str. Flg. Gov.	In Creep Range
Left Head	2.500	0.00	4.690	3.0000	Yes	No
Cylinder	2.500	0.00	3.809	3.0000	N/A	No
Right Cap	2.500	0.00	4.690	3.0000	Yes	No

**Element Types and Properties:**

Element Type	"To" Elev mm	Element Length mm	Nominal Thickness mm	Finished Thickness mm	Reqd Thk Internal mm	Reqd Thk External mm	Long Eff	Circ Eff
Ellipse	0.0	63.4	9.3	9.3	6.2	...	0.85	0.85
Cylinder	750.0	750.0	9.3	8.1	6.4	...	0.85	0.85
Ellipse	813.4	63.4	9.3	9.3	6.2	...	0.85	0.85

N2 Pulsation damper second stage discharge

C220006CLC012

Static Calculation

PV Elite 24 SP1 Licensee: PPV-Engineering B.V.

FileName : 2nd-stage Discharge\_LI4736 -----

Vessel Design Summary: Step: 15 9:13am Jun 21,2022

**Weights:**

Fabricated - Bare W/O Removable Internals	75.3	kgm
Shop Test - Fabricated + Water ( Full )	124.9	kgm
Shipping - Fab. + Rem. Intls.+ Shipping App.	75.3	kgm
Erected - Fab. + Rem. Intls.+ Insul. (etc)	75.3	kgm
Empty - Fab. + Intls. + Details + Wghts.	75.3	kgm
Operating - Empty + Operating Liquid (No CA)	75.3	kgm
Field Test - Empty Weight + Water (Full)	124.9	kgm

**PV Elite is a trademark of Hexagon AB, 2022, All rights reserved.**

N2 Pulsation damper second stage discharge  
C220006CLC012

Static Calculation

PV Elite 24 SP1 Licensee: PPV-Engineering B.V.

FileName : 2nd-stage Discharge\_LI4736 -----

Nozzle Summary: Step: 13 9:13am Jun 21, 2022

**Nozzle Calculation Summary (MPa & mm):**

Description	MAWP	Ext	MAPNC	UG-45	[tr]	Weld Path	Areas or Stresses
Noz N1	4.69	...	...	OK	5.69	OK	No Calc[*]
N2	3.809	...	...	OK	5.80	OK	No Calc[*]
N3	3.809	...	...	OK	5.80	OK	No Calc[*]

**Nozzle MAWP Summary:**

Minimum MAWP Nozzles : 3.809 Nozzle : N3  
 Minimum MAWP Shells/Flanges : 3.809 Element : Cylinder  
 Minimum MAPnc Shells/Flanges : 6.099 Element : Cylinder  
 -----  
 Computed Vessel M.A.W.P. : 3.809 MPa

[\*] - This was a small opening and the areas were not computed.

Note: MAWPs (Internal Case) shown above are at the High Point.

*Multiple output lines for the same nozzle indicates required Code calculations in both the longitudinal and circumferential planes of reinforcement where applicable.*

**Check the Spatial Relationship between the Nozzles:**

From Node	Nozzle Description	X Coordinate mm	Layout Angle deg	Dia. Limit mm
10	Noz N1	0.000	0.000	97.700
20	N2	737.360	270.000	97.700
20	N3	438.360	270.000	54.672

**The nozzle spacing is computed by the following:**

= sqrt( ll<sup>2</sup> + lc<sup>2</sup> ) where

ll - Arc length along the inside vessel surface in the long. direction.

lc - Arc length along the inside vessel surface in the circ. direction

If any interferences/violations are found, they will be noted below.

No interference violations have been detected!

**PV Elite is a trademark of Hexagon AB, 2022, All rights reserved.**

## N2 Pulsation damper second stage discharge

C220006CLC012

## Static Calculation

PV Elite 24 SP1 Licensee: PPV-Engineering B.V.

FileName : 2nd-stage Discharge\_LI4736

Nozzle Schedule: Step: 12 9:13am Jun 21, 2022

**Nozzle Schedule:**

Description	Nominal or Actual Size	Schd or FVC Type	Flg Type	Nozzle O/Dia mm	Wall Thk mm	Reinforcing Pad Diameter	Pad Thk mm	Cut Length mm	Flg Class
N3	38 mm	Actual	None	38.1	8.382	...	...	57	...
Noz N1	50 mm	160	WNF	60.3	8.738	...	...	76	300
N2	50 mm	160	WNF	60.3	8.738	...	...	79	300

*General Notes for the above table:*

The Cut Length is the Outside Projection + Inside Projection + Drop + In Plane Shell Thickness. This value does not include weld gaps, nor does it account for shrinkage.

In the case of Oblique Nozzles, the Outside Diameter must be increased. The Re-Pad WIDTH around the nozzle is calculated as follows:  
Width of Pad = (Pad Outside Dia. (per above) - Nozzle Outside Dia.)/2

For hub nozzles, the thickness and diameter shown are those of the smaller and thinner section.

**Nozzle Material and Weld Fillet Leg Size Details (mm):**

Description	Material	Shl Grve Weld	Noz Shl/Pad Weld	Pad OD Weld	Pad Grve Weld	Inside Weld
N3	SA-106 B	8.340	6.000	...	...	...
Noz N1	SA-106 B	8.110	7.000	...	...	...
N2	SA-106 B	8.340	6.000	...	...	...

Note: The Outside projections below do not include the flange thickness.

**Nozzle Miscellaneous Data:**

Description	Elev/Distance From Datum mm	Layout Angle deg	Proj Outside mm	Proj Inside mm	Installed in Component
N3	375.000	270.0	47.62	0.00	Cylinder
Noz N1	...	0.0	65.00	0.00	Left Head
N2	674.000	270.0	68.00	0.00	Cylinder

PV Elite is a trademark of Hexagon AB, 2022, All rights reserved.

N2 Pulsation damper second stage discharge

C220006CLC012

Static Calculation

PV Elite 24 SP1 Licensee: PPV-Engineering B.V.

FileName : 2nd-stage Discharge\_LI4736 -----

Bill of Material: Step: 11 9:13am Jun 21,2022

**Bill of Materials:**

QTY	DESCRIPTION	MATERIAL
2	ELLIPTICAL HEAD: 2.0 X 1, 9.3mm THK X 254.5mm ID X 63.4mm	SA-234 WPB
1	CYLINDER: 9.3mm THK X 256.8mm ID X 750.0mm	SA-106 B
1	NAMEPLATE	...

PV Elite is a trademark of Hexagon AB, 2022, All rights reserved.

N2 Pulsation damper second stage discharge

C220006CLC012

Static Calculation

PV Elite 24 SP1 Licensee: PPV-Engineering B.V.

FileName : 2nd-stage Discharge\_LI4736 -----

Input Echo: Step: 1 9:13am Jun 21, 2022

### Units used in this Analysis (SI\_ASME):

Name	System Unit	Constant	User Unit
Length	Feet	304.8000	mm
Force	Pounds	4.4480	N
Mass	Pounds	0.4536	kgm
Area	sq. inches	645.1600	mm <sup>2</sup>
Moment	ft. lbs.	1356.3000	N-mm
Stress	lbs./sq.in.	0.0069	MPa
Temperature	Degrees F	0.5556	°C
Pressure	psig	0.0069	MPa
Elast. Modulus	lbs./sq.in.	0.0069	MPa
Pipe Density	lbs./cu.in.	0.0277	kg/cm <sup>3</sup>
Ins. Density	lbs./cu.ft.	0.1602E-04	kg/cm <sup>3</sup>
Fluid Density	lbs./cu.ft.	0.1602E-04	kg/cm <sup>3</sup>
Wind Speed	miles/hr	1.6093	km/hr
Tray Weight	lbs./sq.ft.	0.0005	kg/cm <sup>2</sup>
Inertia	in.**4	416231.0000	mm**4
G Load	G's	1.0000	g's
Wind Load	lbs./sq.ft.	0.0479	kPa
Elevation	Feet	304.8000	mm
Volume	in.**3	0.0164	ltr
Diameter	inches	25.4000	mm
Thickness	inches	25.4000	mm

### PV Elite Vessel Analysis Program: Input Data

N2 Pulsation damper second stage discharge

C220006CLC012

Static Calculation

Design Internal Pressure (for Hydrotest)	2.5	MPa
Design Internal Temperature	100.0	°C
Projection of Nozzle from Vessel Top	0	mm
Projection of Nozzle from Vessel Bottom	0	mm
Minimum Design Metal Temperature	-28.9	°C
Type of Construction	Welded	
Special Service	None	
Degree of Radiography	RT-3	
Use Higher Longitudinal Stresses (Flag)	Y	
Select t for Internal Pressure (Flag)	N	
Select t for External Pressure (Flag)	N	
Select t for Axial Stress (Flag)	N	
Select Location for Stiff. Rings (Flag)	N	
Consider Vortex Shedding	N	

### Shop Pressure Test:

Type of Pressure Test	User Entered Pressure
Pressure Test Position	Horizontal

Load Case 1	NP+EW+WI+FW+BW
Load Case 2	NP+EW+EE+FS+BS
Load Case 3	NP+OW+WI+FW+BW
Load Case 4	NP+OW+EQ+FS+BS
Load Case 5	NP+HW+HI
Load Case 6	NP+HW+HE

## N2 Pulsation damper second stage discharge

C220006CLC012

## Static Calculation

PV Elite 24 SP1 Licensee: PPV-Engineering B.V.

FileName : 2nd-stage Discharge\_LI4736

Input Echo: Step: 1 9:13am Jun 21, 2022

Load Case 7	IP+OW+WI+FW+BW
Load Case 8	IP+OW+EQ+FS+BS
Load Case 9	EP+OW+WI+FW+BW
Load Case 10	EP+OW+EQ+FS+BS
Load Case 11	HP+HW+HI
Load Case 12	HP+HW+HE
Load Case 13	IP+WE+EW
Load Case 14	IP+WF+CW
Load Case 15	IP+VO+OW
Load Case 16	IP+VE+EW
Load Case 17	NP+VO+OW
Load Case 18	FS+BS+IP+OW
Load Case 19	FS+BS+EP+OW

Wind Design Code No Wind Loads

Seismic Design Code No Seismic

Design Pressure + Static Head	Y
Consider MAP New and Cold in Noz. Design	N
Consider External Loads for Nozzle Des.	Y
Use ASME VIII-1 Appendix 1-9	N

Perform Blast Load Analysis	No
Material Database Year	Current w/Addenda or Code Year

**Configuration Directives:**

Do not use Nozzle MDMT Interpretation VIII-1 01-37	No
Use Table G instead of exact equation for "A"	Yes
Shell Head Joints are Tapered	Yes
Compute "K" in corroded condition	Yes
Use Code Case 2286	No
Use the MAWP to compute the MDMT	Yes
For thickness ratios $\leq 0.35$ , MDMT will be -155F (-104C)	Yes
For PWHT & P1 Materials the MDMT can be $< -55F (-48C)$	No
Using Metric Material Databases, ASME II D	No
Calculate B31.3 type stress for Nozzles with Loads	Yes
Reduce the MDMT due to lower membrane stress	Yes
Consider Longitudinal Stress in MDMT Calculations	Yes

**Complete Listing of Vessel Elements and Details:**

Element From Node	10
Element To Node	20
Element Type	Elliptical
Description	Left Head
Distance "FROM" to "TO"	63.36 mm
Element Outside Diameter	273 mm
Element Thickness	9.27 mm
Internal Corrosion Allowance	3 mm
Nominal Thickness	9.27 mm
External Corrosion Allowance	0 mm
Design Internal Pressure	2.5 MPa
Design Temperature Internal Pressure	100 °C
Design External Pressure	0 MPa
Design Temperature External Pressure	100 °C
Effective Diameter Multiplier	1.2

N2 Pulsation damper second stage discharge  
 C220006CLC012

Static Calculation

PV Elite 24 SP1 Licensee: PPV-Engineering B.V.

FileName : 2nd-stage Discharge\_LI4736 -----

Input Echo: Step: 1 9:13am Jun 21, 2022

Material Name	SA-234 WPB	
Allowable Stress, Ambient	117.9	MPa
Allowable Stress, Operating	117.9	MPa
Allowable Stress, Hydrotest	153.28	MPa
Material Density	0.00775	kg/cm <sup>3</sup>
P Number Thickness	30.988	mm
Yield Stress, Operating	220.34	MPa
UCS-66 Chart Curve Designation	B	
External Pressure Chart Name	CS-2	
UNS Number	K03006	
Product Form	Smls. & wld. fittings	
Efficiency, Longitudinal Seam	0.85	
Efficiency, Circumferential Seam	0.85	
Elliptical Head Factor	2.0	
Weld is pre-Heated	No	

Element From Node	10	
Detail Type	Nozzle	
Detail ID	Noz N1	
Dist. from "FROM" Node / Offset dist	0	mm
Nozzle Diameter	50	mm
Nozzle Schedule	160	
Nozzle Class	300	
Layout Angle	0.0	
Blind Flange (Y/N)	N	
Weight of Nozzle ( Used if > 0 )	0	N
Grade of Attached Flange	GR 1.1	
Nozzle Matl	SA-106 B	

-----

Element From Node	20	
Element To Node	30	
Element Type	Cylinder	
Description	Cylinder	
Distance "FROM" to "TO"	750	mm
Element Outside Diameter	273	mm
Element Thickness	8.11	mm
Internal Corrosion Allowance	3	mm
Nominal Thickness	9.27	mm
External Corrosion Allowance	0	mm
Design Internal Pressure	2.5	MPa
Design Temperature Internal Pressure	100	°C
Design External Pressure	0	MPa
Design Temperature External Pressure	100	°C
Effective Diameter Multiplier	1.2	
Material Name	SA-106 B	
Allowable Stress, Ambient	117.9	MPa
Allowable Stress, Operating	117.9	MPa
Allowable Stress, Hydrotest	153.28	MPa
Material Density	0.00775	kg/cm <sup>3</sup>
P Number Thickness	30.988	mm
Yield Stress, Operating	220.34	MPa
UCS-66 Chart Curve Designation	B	
External Pressure Chart Name	CS-2	
UNS Number	K03006	
Product Form	Smls. pipe	
Efficiency, Longitudinal Seam	0.85	
Efficiency, Circumferential Seam	0.85	

N2 Pulsation damper second stage discharge  
C220006CLC012

Static Calculation

PV Elite 24 SP1 Licensee: PPV-Engineering B.V.

FileName : 2nd-stage Discharge\_LI4736

Input Echo: Step: 1 9:13am Jun 21,2022

Weld is pre-Heated	No
Element From Node	20
Detail Type	Nozzle
Detail ID	N2
Dist. from "FROM" Node / Offset dist	674 mm
Nozzle Diameter	50 mm
Nozzle Schedule	160
Nozzle Class	300
Layout Angle	270.0
Blind Flange (Y/N)	N
Weight of Nozzle ( Used if > 0 )	0 N
Grade of Attached Flange	GR 1.1
Nozzle Matl	SA-106 B
Element From Node	20
Detail Type	Nozzle
Detail ID	N3
Dist. from "FROM" Node / Offset dist	375 mm
Nozzle Diameter	38.1 mm
Nozzle Schedule	None
Nozzle Class	None
Layout Angle	270.0
Blind Flange (Y/N)	N
Weight of Nozzle ( Used if > 0 )	0 N
Grade of Attached Flange	None
Nozzle Matl	SA-106 B

Element From Node	30
Element To Node	40
Element Type	Elliptical
Description	Right Cap
Distance "FROM" to "TO"	63.36 mm
Element Outside Diameter	273 mm
Element Thickness	9.27 mm
Internal Corrosion Allowance	3 mm
Nominal Thickness	9.27 mm
External Corrosion Allowance	0 mm
Design Internal Pressure	2.5 MPa
Design Temperature Internal Pressure	100 °C
Design External Pressure	0 MPa
Design Temperature External Pressure	100 °C
Effective Diameter Multiplier	1.2
Material Name	SA-234 WPB
Allowable Stress, Ambient	117.9 MPa
Allowable Stress, Operating	117.9 MPa
Allowable Stress, Hydrotest	153.28 MPa
Material Density	0.00775 kg/cm <sup>3</sup>
P Number Thickness	30.988 mm
Yield Stress, Operating	220.34 MPa
UCS-66 Chart Curve Designation	B
External Pressure Chart Name	CS-2
UNS Number	K03006
Product Form	Smls. & wld. fittings
Efficiency, Longitudinal Seam	0.85
Efficiency, Circumferential Seam	0.85
Elliptical Head Factor	2.0

N2 Pulsation damper second stage discharge

C220006CLC012

Static Calculation

PV Elite 24 SP1 Licensee: PPV-Engineering B.V.

FileName : 2nd-stage Discharge\_LI4736 -----

Input Echo: Step: 1 9:13am Jun 21,2022

Weld is pre-Heated

No

**PV Elite is a trademark of Hexagon AB, 2022, All rights reserved.**

N2 Pulsation damper second stage discharge  
C220006CLC012

Static Calculation

PV Elite 24 SP1 Licensee: PPV-Engineering B.V.

FileName : 2nd-stage Discharge\_LI4736

Internal Pressure Calculations: Step: 3 9:13am Jun 21, 2022

### Internal Pressure Results Summary:

#### Element Thickness, Pressure, Diameter and Allowable Stress :

From	To	Int. Press + Liq. Hd MPa	Nominal Thickness mm	Total Corr Allowance mm	Element Diameter mm	Allowable Stress(SE) MPa
Left Head		2.5	9.27	3	273	100.22
Cylinder		2.5	9.27	3	273	100.22
Right Cap		2.5	9.27	3	273	100.22

#### Element Required Thickness and MAWP :

From	To	Design Pressure MPa	M.A.W.P. Corroded MPa	M.A.P. New & Cold MPa	Minimum Thickness mm	Required Thickness mm
Left Head		2.5	4.69	7.249	9.27	6.23376
Cylinder		2.5	3.809	6.099	8.11	6.37141
Right Cap		2.5	4.69	7.249	9.27	6.23376
Minimum			3.809	5.11		

Note : The M.A.P.(NC) is Governed by a Flange !

MAWP: 3.809 MPa, limited by: Cylinder.

Elements Suitable for Design Internal Pressure.

### Internal Pressure Calculation Results:

#### ASME Code, Section VIII Division 1, 2021

#### Elliptical Head From 10 To 20 SA-234 WPB , UCS-66 Crv. B at 100 °C

Left Head

Longitudinal Joint: User Defined

Material UNS Number: K03006

Required Thickness due to Internal Pressure [tr]:

$$\begin{aligned}
 &= (P \cdot D_o \cdot K_{cor}) / (2 \cdot S \cdot E + 2 \cdot P \cdot (K_{cor} - 0.1)) \text{ per Appendix 1-4 (c)} \\
 &= (2.5 \cdot 273 \cdot 0.97) / (2 \cdot 117.9 \cdot 0.85 + 2 \cdot 2.5 \cdot (0.97 - 0.1)) \\
 &= 3.2338 + 3.0000 = 6.2338 \text{ mm}
 \end{aligned}$$

Max. Allowable Working Pressure at given Thickness, corroded [MAWP]:

$$\begin{aligned}
 &= (2 \cdot S \cdot E \cdot t) / (K_{cor} \cdot D_o - 2 \cdot t \cdot (K_{cor} - 0.1)) \text{ per Appendix 1-4 (c)} \\
 &= (2 \cdot 117.9 \cdot 0.85 \cdot 6.27) / (0.97 \cdot 273 - 2 \cdot 6.27 \cdot (0.97 - 0.1)) \\
 &= 4.948 \text{ MPa}
 \end{aligned}$$

Maximum Allowable Pressure, New and Cold [MAPNC]:

$$\begin{aligned}
 &= (2 \cdot S \cdot E \cdot t) / (K \cdot D_o - 2 \cdot t \cdot (K - 0.1)) \text{ per Appendix 1-4 (c)} \\
 &= (2 \cdot 117.9 \cdot 0.85 \cdot 9.27) / (1 \cdot 273 - 2 \cdot 9.27 \cdot (1 - 0.1)) \\
 &= 7.249 \text{ MPa}
 \end{aligned}$$

N2 Pulsation damper second stage discharge  
C220006CLC012

**Static Calculation**

PV Elite 24 SP1 Licensee: PPV-Engineering B.V.

FileName : 2nd-stage Discharge\_LI4736 -----

Internal Pressure Calculations: Step: 3 9:13am Jun 21, 2022

Actual stress at given pressure and thickness, corroded [Sact]:

$$= (P*(Kcor*Do-2*t*(Kcor-0.1)))/(2*E*t)$$

$$= (2.5*(0.97*273-2*6.27*(0.97-0.1)))/(2*0.85*6.27)$$

$$= 59.570 \text{ MPa}$$

Straight Flange Required Thickness:

$$= (P*Ro)/(S*E+0.4*P) + ca \text{ per Appendix 1-1 (a)(1)}$$

$$= (2.5*136.5)/(117.9*0.85+0.4*2.5)+3$$

$$= 6.371 \text{ mm}$$

Straight Flange Maximum Allowable Working Pressure:

$$= (S*E*t)/(Ro-0.4*t) \text{ per Appendix 1-1 (a)(1)}$$

$$= (117.9 * 0.85 * 6.27)/(136.5 - 0.4 * 6.27)$$

$$= 4.69 \text{ MPa}$$

Factor K, corroded condition [Kcor]:

$$= (2 + (\text{Inside Diameter}/(2 * \text{Inside Head Depth}))^2)/6$$

$$= (2 + (260.5/(2 * 66.61))^2)/6$$

$$= 0.970315$$

**MDMT Calculations in the Knuckle Portion:**

Govrn. thk, tg = 9.27, tr = 4.873, c = 3 mm, E\* = 0.85

Thickness Ratio = tr \* E\*/(tg - c) = 0.661, Temp. Reduction = 19 °C

Min Metal Temp. w/o impact per UCS-66, Curve B -29 °C  
Min Metal Temp. at Required thickness (UCS 66.1) -48 °C

**MDMT Calculations in the Head Straight Flange:**

Govrn. thk, tg = 9.27, tr = 5.11, c = 3 mm, E\* = 0.85

Thickness Ratio = tr \* E\*/(tg - c) = 0.693, Temp. Reduction = 17 °C

Min Metal Temp. w/o impact per UCS-66, Curve B -29 °C  
Min Metal Temp. at Required thickness (UCS 66.1) -46 °C

**Cylindrical Shell From 20 To 30 SA-106 B , UCS-66 Crv. B at 100 °C**

Cylinder

Longitudinal Joint: Spot Radiography per UW-11(b) Type 1

Material UNS Number: K03006

Required Thickness due to Internal Pressure [tr]:

$$= (P*Ro) / (S*E+0.4*P) \text{ per Appendix 1-1 (a)(1)}$$

$$= (2.5*136.5)/(117.9*0.85+0.4*2.5)$$

$$= 3.3714 + 3.0000 = 6.3714 \text{ mm}$$

Max. Allowable Working Pressure at given Thickness, corroded [MAWP]:

$$= (S*E*t)/(Ro-0.4*t) \text{ per Appendix 1-1 (a)(1)}$$

$$= (117.9*0.85*5.11)/(136.5-0.4*5.11)$$

$$= 3.809 \text{ MPa}$$

Maximum Allowable Pressure, New and Cold [MAPNC]:

$$= (S*E*t)/(Ro-0.4*t) \text{ per Appendix 1-1 (a)(1)}$$

$$= (117.9*0.85*8.11)/(136.5-0.4*8.11)$$

$$= 6.099 \text{ MPa}$$

N2 Pulsation damper second stage discharge  
C220006CLC012

Static Calculation

PV Elite 24 SP1 Licensee: PPV-Engineering B.V.

FileName : 2nd-stage Discharge\_LI4736 -----

Internal Pressure Calculations: Step: 3 9:13am Jun 21, 2022

Actual stress at given pressure and thickness, corroded [Sact]:

$$= (P*(Ro-0.4*t))/(E*t)$$

$$= (2.5*((136.5-0.4*5.11))/(0.85*5.11))$$

$$= 77.389 \text{ MPa}$$

**Minimum Design Metal Temperature Results:**

Govrn. thk, tg = 8.11, tr = 2.478, c = 3 mm, E\* = 0.85

Thickness Ratio = tr \* E\*/(tg - c) = 0.412, Temp. Reduction = 48 °C

Min Metal Temp. w/o impact per UCS-66, Curve B -29 °C

Min Metal Temp. at Required thickness (UCS 66.1) -48 °C

**Elliptical Head From 30 To 40 SA-234 WPB, UCS-66 Crv. B at 100 °C**

Right Cap

Longitudinal Joint: User Defined

Material UNS Number: K03006

Required Thickness due to Internal Pressure [tr]:

$$= (P*Do*Kcor)/(2*S*E+2*P*(Kcor-0.1)) \text{ per Appendix 1-4 (c)}$$

$$= (2.5*273*0.97)/(2*117.9*0.85+2*2.5*(0.97-0.1))$$

$$= 3.2338 + 3.0000 = 6.2338 \text{ mm}$$

Max. Allowable Working Pressure at given Thickness, corroded [MAWP]:

$$= (2*S*E*t)/(Kcor*Do-2*t*(Kcor-0.1)) \text{ per Appendix 1-4 (c)}$$

$$= (2*117.9*0.85*6.27)/(0.97*273-2*6.27*(0.97-0.1))$$

$$= 4.948 \text{ MPa}$$

Maximum Allowable Pressure, New and Cold [MAPNC]:

$$= (2*S*E*t)/(K*Do-2*t*(K-0.1)) \text{ per Appendix 1-4 (c)}$$

$$= (2*117.9*0.85*9.27)/(1*273-2*9.27*(1-0.1))$$

$$= 7.249 \text{ MPa}$$

Actual stress at given pressure and thickness, corroded [Sact]:

$$= (P*(Kcor*Do-2*t*(Kcor-0.1)))/(2*E*t)$$

$$= (2.5*(0.97*273-2*6.27*(0.97-0.1)))/(2*0.85*6.27)$$

$$= 59.570 \text{ MPa}$$

Straight Flange Required Thickness:

$$= (P*Ro)/(S*E+0.4*P) + ca \text{ per Appendix 1-1 (a)(1)}$$

$$= (2.5*136.5)/(117.9*0.85+0.4*2.5)+3$$

$$= 6.371 \text{ mm}$$

Straight Flange Maximum Allowable Working Pressure:

$$= (S*E*t)/(Ro-0.4*t) \text{ per Appendix 1-1 (a)(1)}$$

$$= (117.9 * 0.85 * 6.27)/(136.5 - 0.4 * 6.27)$$

$$= 4.69 \text{ MPa}$$

Factor K, corroded condition [Kcor]:

$$= (2 + (\text{Inside Diameter}/(2 * \text{Inside Head Depth}))^2)/6$$

$$= (2 + (260.5/(2 * 66.61))^2)/6$$

$$= 0.970315$$

**MDMT Calculations in the Knuckle Portion:**

Govrn. thk, tg = 9.27, tr = 4.873, c = 3 mm, E\* = 0.85

N2 Pulsation damper second stage discharge  
C220006CLC012

Static Calculation

PV Elite 24 SP1 Licensee: PPV-Engineering B.V.

FileName : 2nd-stage Discharge\_LI4736

Internal Pressure Calculations: Step: 3 9:13am Jun 21, 2022

Thickness Ratio =  $tr * E^* / (tg - c) = 0.661$ , Temp. Reduction = 19 °C

Min Metal Temp. w/o impact per UCS-66, Curve B -29 °C

Min Metal Temp. at Required thickness (UCS 66.1) -48 °C

**MDMT Calculations in the Head Straight Flange:**

Govrn. thk,  $tg = 9.27$ ,  $tr = 5.11$ ,  $c = 3$  mm,  $E^* = 0.85$

Thickness Ratio =  $tr * E^* / (tg - c) = 0.693$ , Temp. Reduction = 17 °C

Min Metal Temp. w/o impact per UCS-66, Curve B -29 °C

Min Metal Temp. at Required thickness (UCS 66.1) -46 °C

Note: Heads and Shells Exempted to -20F (-29C) by paragraph UG-20F

**Hydrostatic Test Pressure Results:**

Pressure per UG99b =  $1.30 * M.A.W.P. * Sa/S$  4.951 MPa

Pressure per UG99b[35] =  $1.30 * Design Pres * Sa/S$  3.250 MPa

Pressure per UG99c =  $1.30 * M.A.P. - Head(Hyd)$  6.643 MPa

Pressure per UG100 =  $1.10 * M.A.W.P. * Sa/S$  4.190 MPa

Pressure per PED =  $\max(1.43*DP, 1.25*DP*ratio)$  3.575 MPa

Pressure per App 27-4 = M.A.W.P. 3.809 MPa

User Defined Hydrostatic Test Pressure at High Point 6.640 MPa

**Horizontal Test performed per: User Hydro Pressure**

Please note that Nozzle, Shell, Head, Flange, etc MAWPs are all considered when determining the hydrotest pressure for those test types that are based on the MAWP of the vessel.

**Stresses on Elements due to Test Pressure (MPa):**

From To	Stress	Allowable	Ratio	Pressure
Left Head	108.0	153.3	0.705	6.64
Cylinder	128.4	153.3	0.838	6.64
Right Cap	108.0	153.3	0.705	6.64

**Stress ratios for Nozzle and Pad Materials (MPa):**

Description	Pad/Nozzle	Ambient	Operating	Ratio
Noz N1	Nozzle	117.90	117.90	1.000
N2	Nozzle	117.90	117.90	1.000
N3	Nozzle	117.90	117.90	1.000
Minimum				1.000

**Stress ratios for Pressurized Vessel Elements (MPa):**

Description	Ambient	Operating	Ratio
Left Head	117.90	117.90	1.000
Cylinder	117.90	117.90	1.000
Right Cap	117.90	117.90	1.000

N2 Pulsation damper second stage discharge

C220006CLC012

Static Calculation

PV Elite 24 SP1 Licensee: PPV-Engineering B.V.

FileName : 2nd-stage Discharge\_LI4736 -----

Internal Pressure Calculations: Step: 3 9:13am Jun 21,2022

-----  
Minimum 1.000

**Hoop Stress in Nozzle Wall during Pressure Test (MPa):**

Description	Ambient	Operating	Ratio
Noz N1	20.27	153.28	0.132
N2	20.27	153.28	0.132
N3	12.44	153.28	0.081

Elements Suitable for Test Pressure.

**PV Elite is a trademark of Hexagon AB, 2022, All rights reserved.**

N2 Pulsation damper second stage discharge  
C220006CLC012

Static Calculation

PV Elite 24 SP1 Licensee: PPV-Engineering B.V.

FileName : 2nd-stage Discharge\_LI4736 -----

Element and Detail Weights: Step: 5 9:13am Jun 21, 2022

**Element and Detail Weights:**

From	To	Element Metal Wgt. kgm	Element ID Volume ltr	Corroded Metal Wgt. kgm	Corroded ID Volume ltr	Extra due Misc %
10	20	9.75261	5.37984	6.59643	5.68983	...
20	30	45.0385	38.8465	30.8064	40.6831	...
30	40	9.75261	5.37984	6.59643	5.68983	...
Total		64	49.61	43	52.06	0

**Weight of Details:**

From	Type	Weight of Detail kgm	X Offset, Dtl. Cent. mm	Y Offset, Dtl. Cent. mm	Z Offset, Dtl. Cent. mm	Description
10	Noz1	5.21238	-63.615	...	...	Noz N1
20	Noz1	5.24528	674	-158.553	...	N2
20	Noz1	0.28886	375	-147.44	...	N3

**Total Weight of Each Detail Type:**

Nozzles	10.7
-----	
Sum of the Detail Weights	10.7 kgm

**Weight Summation Results: (kgm)**

	Fabricated	Shop Test	Shipping	Erected	Empty	Operating
Main Elements	64.5	64.5	64.5	64.5	64.5	64.5
Nozzles	10.7	10.7	10.7	10.7	10.7	10.7
Test Liquid	...	49.6	...	...	...	...
Totals	75.3	124.9	75.3	75.3	75.3	75.3

**Weight Summary:**

Fabricated Wt.	- Bare Weight without Removable Internals	75.3 kgm
Shop Test Wt.	- Fabricated Weight + Water ( Full )	124.9 kgm
Shipping Wt.	- Fab. Weight + removable Intls.+ Shipping App.	75.3 kgm
Erected Wt.	- Fab. Wt + or - loose items (trays,platforms etc.)	75.3 kgm
Ope. Wt. no Liq	- Fab. Weight + Internals. + Details + Weights	75.3 kgm
Operating Wt.	- Empty Weight + Operating Liq. Uncorroded	75.3 kgm
Oper. Wt. + CA	- Corr Wt. + Operating Liquid	54.7 kgm
Field Test Wt.	- Empty Weight + Water (Full)	124.9 kgm

Note:

The Corroded Weight and thickness are used in the Horizontal Vessel Analysis (Ope Case) and Earthquake Load Calculations.

**Outside Surface Areas of Elements:**

From	To	Surface Area
------	----	--------------

N2 Pulsation damper second stage discharge

C220006CLC012

Static Calculation

PV Elite 24 SP1 Licensee: PPV-Engineering B.V.

FileName : 2nd-stage Discharge\_LI4736 -----

Element and Detail Weights: Step: 5 9:13am Jun 21, 2022

		mm <sup>2</sup>
10	20	135129
20	30	648708
30	40	135129
Total		918966.188 mm <sup>2</sup>

PV Elite is a trademark of Hexagon AB, 2022, All rights reserved.

N2 Pulsation damper second stage discharge  
 C220006CLC012

Static Calculation

PV Elite 24 SP1 Licensee: PPV-Engineering B.V.

FileName : 2nd-stage Discharge\_LI4736 -----

Nozzle Flange MAWP: Step: 6 9:13am Jun 21,2022

**Nozzle Flange MAWP Results: (MPa & °C)**

Nozzle Description	Flange Rating		Design	Class	Grade/Group	Equiv. Press	Max Pressure		
	Op.	Ambient	Temp				UG-44(b)	50%	DNV
Noz N1	4.66	5.11	100	300	GR 1.1	...	...	...	...
N2	4.66	5.11	100	300	GR 1.1	...	...	...	...
Min Rating	4.660	5.110 MPa [for Core Elements]					...	...	...

Pressure Ratings are per ASME B16.5 2017 Metric Edition

**PV Elite is a trademark of Hexagon AB, 2022, All rights reserved.**

N2 Pulsation damper second stage discharge  
 C220006CLC012

Static Calculation

PV Elite 24 SP1 Licensee: PPV-Engineering B.V.

FileName : 2nd-stage Discharge\_LI4736 -----

Nozzle Calcs.: Noz N1 Nozl: 13 9:13am Jun 21, 2022

**Input, Nozzle Desc: Noz N1 From: 10**

Pressure for Reinforcement Calculations	P	2.5000	MPa
Temperature for Internal Pressure	Temp	100	°C
Parent Material		SA-234	WPB
Parent Allowable Stress at Temperature	Sv	117.90	MPa
Parent Allowable Stress At Ambient	Sva	117.90	MPa
Inside Diameter of Elliptical Head	D	254.46	mm
Aspect Ratio of Elliptical Head	Ar	2.00	
Head Finished (Minimum) Thickness	t	9.2700	mm
Head Internal Corrosion Allowance	c	3.0000	mm
Head External Corrosion Allowance	co	0.0000	mm
Distance from Head Centerline	L1	0.0000	mm
User Entered Minimum Design Metal Temperature		-28.89	°C

**Type of Element Connected to the Parent : Nozzle**

Material		SA-106	B
Material UNS Number		K03006	
Material Specification/Type		Smls.	pipe
Allowable Stress at Temperature	Sn	117.90	MPa
Allowable Stress At Ambient	Sna	117.90	MPa
Diameter Basis (for tr calc only)		Outside	
Layout Angle		0.00	deg
Diameter		50.0000	mm
Size and Thickness Basis		Nominal	
Nominal Thickness		160	
Flange Material		SA-105	
Flange Type		Weld Neck	Flange
Corrosion Allowance	can	3.0000	mm
Joint Efficiency of Shell Seam at Nozzle	E1	1.00	
Joint Efficiency of Nozzle Neck	En	1.00	
Outside Projection	ho	65.0000	mm
Weld leg size between Nozzle and Pad/Shell	Wo	7.0000	mm
Groove weld depth between Nozzle and Vessel Wgnv		8.1100	mm
Flange Class		300	
Flange Grade		GR 1.1	

The Pressure Design option was Design Pressure + static head.

**Nozzle Sketch (may not represent actual weld type/configuration)**

N2 Pulsation damper second stage discharge  
C220006CLC012

Static Calculation

PV Elite 24 SP1 Licensee: PPV-Engineering B.V.

FileName : 2nd-stage Discharge\_LI4736 -----

Nozzle Calcs.: Noz N1 Nozl: 13 9:13am Jun 21, 2022

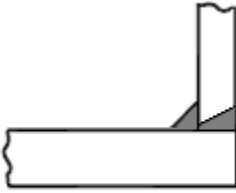

### Abutting/Set-on Nozzle No Pad

### Reinforcement CALCULATION, Description: Noz N1

ASME Code, Section VIII, Div. 1, 2021, UG-37 to UG-45

Actual Outside Diameter Used in Calculation	60.325 mm.
Actual Thickness Used in Calculation	8.738 mm

Nozzle input data check completed without errors.

Reqd thk per UG-37(a) of Elliptical Head, tr [Int. Press]  
 =  $P \cdot D \cdot K1 / (2 \cdot Sv \cdot E - 0.2 \cdot P)$  per Appendix 1-4(c)  
 =  $0.881 \cdot 2.5 \cdot 260.5 / (2 \cdot 117.9 \cdot 1 - 0.2 \cdot 2.5)$   
 = 2.4371 mm

Reqd thk per UG-37(a) of Nozzle Wall, trn [Int. Press]  
 =  $P \cdot Ro / (Sn \cdot E + 0.4 \cdot P)$  per Appendix 1-1 (a)(1)  
 =  $2.5 \cdot 30.16 / (117.9 \cdot 1 + 0.4 \cdot 2.5)$   
 = 0.6342 mm

### UG-40, Limits of Reinforcement : [Internal Pressure]

Parallel to Vessel Wall (Diameter Limit)	D1	97.6996 mm
Parallel to Vessel Wall, opening length	d	48.8498 mm
Normal to Vessel Wall (Thickness Limit), no pad	Tlnp	14.3440 mm

*Taking a UG-36(c)(3)(a) exemption for nozzle: Noz N1.*

*This calculation is valid for nozzles that meet all the requirements of paragraph UG-36. Please check the Code carefully, especially for nozzles that are not isolated or do not meet Code spacing requirements. To force the computation of areas for small nozzles go to Tools->Configuration and check the box to force the UG-37 small nozzle area calculation.*

### UG-45 Minimum Nozzle Neck Thickness Requirement: [Int. Press.]

Wall Thickness for Internal/External pressures	ta = 3.6342 mm
Wall Thickness per UG16(b),	tr16b = 4.5000 mm
Wall Thickness, shell/head, internal pressure	trb1 = 5.6851 mm
Wall Thickness	tb1 = max(trb1, tr16b) = 5.6851 mm
Wall Thickness	tb2 = max(trb2, tr16b) = 4.5000 mm
Wall Thickness per table UG-45	tb3 = 6.4200 mm

Determine Nozzle Thickness candidate [tb]:

= min[ tb3, max( tb1, tb2 ) ]  
 = min[ 6.42, max( 5.685, 4.5 ) ]  
 = 5.6851 mm

Minimum Wall Thickness of Nozzle Necks [tUG-45]:

= max( ta, tb )

N2 Pulsation damper second stage discharge  
C220006CLC012

Static Calculation

PV Elite 24 SP1 Licensee: PPV-Engineering B.V.

FileName : 2nd-stage Discharge\_LI4736 -----

Nozzle Calcs.: Noz N1 Nozl: 13 9:13am Jun 21, 2022

$$= \max( 3.634, 5.685 )$$

$$= 5.6851 \text{ mm}$$

Available Nozzle Neck Thickness =  $0.875 * 8.738 = 7.645 \text{ mm}$  --> OK

### Nozzle Junction Minimum Design Metal Temperature (MDMT) Calculations:

#### Nozzle Neck to Flange Weld, Curve: B

Govrn. thk, tg = 7.645, tr = 0.634, c = 3 mm, E\* = 1  
Thickness Ratio =  $tr * E*/(tg - c) = 0.137$ , Temp. Reduction = 78 °C

Min Metal Temp. w/o impact per UCS-66, Curve B	-29 °C
Min Metal Temp. at Required thickness (UCS 66.1)	-104 °C

#### Nozzle-Shell/Head Weld (UCS-66(a)1(b)), Curve: B

Govrn. thk, tg = 7.645, tr = 0.634, c = 3 mm, E\* = 1  
Thickness Ratio =  $tr * E*/(tg - c) = 0.137$ , Temp. Reduction = 78 °C

Min Metal Temp. w/o impact per UCS-66, Curve B	-29 °C
Min Metal Temp. at Required thickness (UCS 66.1)	-104 °C

Gov. MDMT of the nozzle to shell joint welded assembly : -104 °C

#### Flange MDMT including Temperature reduction per UCS-66.1:

Unadjusted MDMT of ASME B16.5/47 flanges per UCS-66(c)	-18 °C
Flange MDMT with Temp reduction per UCS-66(b)(1)(-b)	-48 °C

Where the Stress Reduction Ratio per UCS-66(b)(1)(-b) is :  
Design Pressure/Ambient Rating =  $2.50/5.11 = 0.489$

#### Weld Size Calculations, Description: Noz N1

Intermediate Calc. for nozzle/shell Welds Tmin 5.7376 mm

#### Results Per UW-16.1:

	Required Thickness	Actual Thickness
Nozzle Weld	$4.0163 = 0.7 * t_{min}$	$4.9490 = 0.7 * W_o$ mm

Skipping the nozzle attachment weld strength calculations. Per UW-15(b)(2) the nozzles exempted by UG-36(c)(3)(a) (small nozzles) do not require a weld strength check.

#### Maximum Allowable Pressure for this Nozzle at this Location:

Converged Maximum Allowable Pressure in the Operating case: 4.69 MPa

Note: The MAWP of this junction was limited by the parent Shell/Head.

The Drop for this Nozzle is : 1.9319 mm  
The Cut Length for this Nozzle is, Drop + Ho + H + T : 76.2019 mm

PV Elite is a trademark of Hexagon AB, 2022, All rights reserved.

N2 Pulsation damper second stage discharge  
 C220006CLC012

Static Calculation

PV Elite 24 SP1 Licensee: PPV-Engineering B.V.

FileName : 2nd-stage Discharge\_LI4736 -----

Nozzle Calcs.: N2 Nozl: 14 9:13am Jun 21, 2022

**Input, Nozzle Desc: N2 From: 20**

Pressure for Reinforcement Calculations	P	2.5000	MPa
Temperature for Internal Pressure	Temp	100	°C
Parent Material		SA-106 B	
Parent Allowable Stress at Temperature	Sv	117.90	MPa
Parent Allowable Stress At Ambient	Sva	117.90	MPa
Inside Diameter of Cylindrical Shell	D	254.46	mm
Shell Finished (Minimum) Thickness	t	8.1100	mm
Shell Internal Corrosion Allowance	c	3.0000	mm
Shell External Corrosion Allowance	co	0.0000	mm
Distance from Bottom/Left Tangent		737.36	mm
User Entered Minimum Design Metal Temperature		-28.89	°C

**Type of Element Connected to the Parent : Nozzle**

Material		SA-106 B	
Material UNS Number		K03006	
Material Specification/Type		Smls. pipe	
Allowable Stress at Temperature	Sn	117.90	MPa
Allowable Stress At Ambient	Sna	117.90	MPa
Diameter Basis (for tr calc only)		Outside	
Layout Angle		270.00	deg
Diameter		50.0000	mm
Size and Thickness Basis		Nominal	
Nominal Thickness		160	
Flange Material		SA-105	
Flange Type		Weld Neck Flange	
Corrosion Allowance	can	3.0000	mm
Joint Efficiency of Shell Seam at Nozzle	E1	1.00	
Joint Efficiency of Nozzle Neck	En	1.00	
Outside Projection	ho	68.0000	mm
Weld leg size between Nozzle and Pad/Shell	Wo	6.0000	mm
Groove weld depth between Nozzle and Vessel Wgnv		8.3400	mm
Flange Class		300	
Flange Grade		GR 1.1	

The Pressure Design option was Design Pressure + static head.

**Nozzle Sketch (may not represent actual weld type/configuration)**

N2 Pulsation damper second stage discharge  
C220006CLC012

Static Calculation

PV Elite 24 SP1 Licensee: PPV-Engineering B.V.

FileName : 2nd-stage Discharge\_LI4736 -----

Nozzle Calcs.: N2 Nozl: 14 9:13am Jun 21, 2022

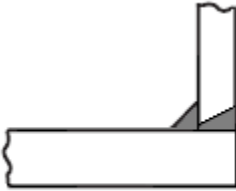

### Abutting/Set-on Nozzle No Pad

### Reinforcement CALCULATION, Description: N2

ASME Code, Section VIII, Div. 1, 2021, UG-37 to UG-45

Actual Outside Diameter Used in Calculation	60.325 mm.
Actual Thickness Used in Calculation	8.738 mm

Nozzle input data check completed without errors.

Reqd thk per UG-37(a) of Cylindrical Shell, tr [Int. Press]

$$= P \cdot R / (S_v \cdot E - 0.6 \cdot P) \text{ per UG-27 (c)(1)}$$

$$= 2.5 \cdot 130.2 / (117.9 \cdot 1 - 0.6 \cdot 2.5)$$

$$= 2.7969 \text{ mm}$$

Reqd thk per UG-37(a) of Nozzle Wall, trn [Int. Press]

$$= P \cdot R_o / (S_n \cdot E + 0.4 \cdot P) \text{ per Appendix 1-1 (a)(1)}$$

$$= 2.5 \cdot 30.16 / (117.9 \cdot 1 + 0.4 \cdot 2.5)$$

$$= 0.6342 \text{ mm}$$

### UG-40, Limits of Reinforcement : [Internal Pressure]

Parallel to Vessel Wall (Diameter Limit)	D1	97.6996 mm
Parallel to Vessel Wall, opening length	d	48.8498 mm
Normal to Vessel Wall (Thickness Limit), no pad	Tlnp	12.7750 mm

*Taking a UG-36(c)(3)(a) exemption for nozzle: N2.*

*This calculation is valid for nozzles that meet all the requirements of paragraph UG-36. Please check the Code carefully, especially for nozzles that are not isolated or do not meet Code spacing requirements. To force the computation of areas for small nozzles go to Tools->Configuration and check the box to force the UG-37 small nozzle area calculation.*

### UG-45 Minimum Nozzle Neck Thickness Requirement: [Int. Press.]

Wall Thickness for Internal/External pressures	ta = 3.6342 mm
Wall Thickness per UG16(b),	tr16b = 4.5000 mm
Wall Thickness, shell/head, internal pressure	trb1 = 5.7969 mm
Wall Thickness	tb1 = max(trb1, tr16b) = 5.7969 mm
Wall Thickness	tb2 = max(trb2, tr16b) = 4.5000 mm
Wall Thickness per table UG-45	tb3 = 6.4200 mm

Determine Nozzle Thickness candidate [tb]:

$$= \min[ tb3, \max( tb1, tb2 ) ]$$

$$= \min[ 6.42, \max( 5.797, 4.5 ) ]$$

$$= 5.7969 \text{ mm}$$

Minimum Wall Thickness of Nozzle Necks [tUG-45]:

$$= \max( ta, tb )$$

N2 Pulsation damper second stage discharge  
C220006CLC012

Static Calculation

PV Elite 24 SP1 Licensee: PPV-Engineering B.V.

FileName : 2nd-stage Discharge\_LI4736 -----

Nozzle Calcs.: N2 Nozl: 14 9:13am Jun 21, 2022

$$= \max( 3.634, 5.797 )$$

$$= 5.7969 \text{ mm}$$

Available Nozzle Neck Thickness =  $0.875 * 8.738 = 7.645 \text{ mm}$  --> OK

### Nozzle Junction Minimum Design Metal Temperature (MDMT) Calculations:

#### Nozzle Neck to Flange Weld, min( Curve:B, Curve:A)

Govrn. thk, tg = 7.645, tr = 0.634, c = 3 mm, E\* = 1  
Thickness Ratio =  $tr * E*/(tg - c) = 0.137$ , Temp. Reduction = 78 °C

Min Metal Temp. w/o impact per UCS-66, Curve A	-8 °C
Min Metal Temp. at Required thickness (UCS 66.1)	-104 °C
Min Metal Temp. w/o impact per UG-20(f)	-29 °C

#### Nozzle-Shell/Head Weld (UCS-66(a)1(b)), Curve: B

Govrn. thk, tg = 7.645, tr = 0.634, c = 3 mm, E\* = 1  
Thickness Ratio =  $tr * E*/(tg - c) = 0.137$ , Temp. Reduction = 78 °C

Min Metal Temp. w/o impact per UCS-66, Curve B	-29 °C
Min Metal Temp. at Required thickness (UCS 66.1)	-104 °C

Gov. MDMT of the nozzle to shell joint welded assembly : -104 °C

#### Flange MDMT including Temperature reduction per UCS-66.1:

Unadjusted MDMT of ASME B16.5/47 flanges per UCS-66(c)	-18 °C
Flange MDMT with Temp reduction per UCS-66(b)(1)(-b)	-48 °C

Where the Stress Reduction Ratio per UCS-66(b)(1)(-b) is :  
Design Pressure/Ambient Rating =  $2.50/5.11 = 0.489$

#### Weld Size Calculations, Description: N2

Intermediate Calc. for nozzle/shell Welds Tmin 5.7376 mm

#### Results Per UW-16.1:

	Required Thickness	Actual Thickness
Nozzle Weld	$4.0163 = 0.7 * t_{min}$	$4.2420 = 0.7 * W_o$ mm

Skipping the nozzle attachment weld strength calculations. Per UW-15(b)(2) the nozzles exempted by UG-36(c)(3)(a) (small nozzles) do not require a weld strength check.

#### Maximum Allowable Pressure for this Nozzle at this Location:

Converged Maximum Allowable Pressure in the Operating case: 3.809 MPa

Note: The MAWP of this junction was limited by the parent Shell/Head.

The Drop for this Nozzle is : 3.6270 mm  
The Cut Length for this Nozzle is, Drop + Ho + H + T : 79.7370 mm

PV Elite is a trademark of Hexagon AB, 2022, All rights reserved.

N2 Pulsation damper second stage discharge  
C220006CLC012

Static Calculation

PV Elite 24 SP1 Licensee: PPV-Engineering B.V.

FileName : 2nd-stage Discharge\_LI4736

Nozzle Calcs.: N3

Noz1: 15 9:13am Jun 21, 2022

**Input, Nozzle Desc: N3**

**From: 20**

Pressure for Reinforcement Calculations	P	2.5000	MPa
Temperature for Internal Pressure	Temp	100	°C
Parent Material		SA-106 B	
Parent Allowable Stress at Temperature	Sv	117.90	MPa
Parent Allowable Stress At Ambient	Sva	117.90	MPa
Inside Diameter of Cylindrical Shell	D	254.46	mm
Shell Finished (Minimum) Thickness	t	8.1100	mm
Shell Internal Corrosion Allowance	c	3.0000	mm
Shell External Corrosion Allowance	co	0.0000	mm
Distance from Bottom/Left Tangent		438.36	mm
User Entered Minimum Design Metal Temperature		-28.89	°C

**Type of Element Connected to the Parent : Nozzle**

Material		SA-106 B	
Material UNS Number		K03006	
Material Specification/Type		Smls. pipe	
Allowable Stress at Temperature	Sn	117.90	MPa
Allowable Stress At Ambient	Sna	117.90	MPa
Diameter Basis (for tr calc only)		Outside	
Layout Angle		270.00	deg
Diameter		38.1000	mm
Size and Thickness Basis		Actual	
Actual Thickness	tn	8.3820	mm
Corrosion Allowance	can	3.0000	mm
Joint Efficiency of Shell Seam at Nozzle	E1	1.00	
Joint Efficiency of Nozzle Neck	En	1.00	
Outside Projection	ho	47.6250	mm
Weld leg size between Nozzle and Pad/Shell	Wo	6.0000	mm
Groove weld depth between Nozzle and Vessel Wgnv		8.3400	mm

The Pressure Design option was Design Pressure + static head.

**Nozzle Sketch (may not represent actual weld type/configuration)**

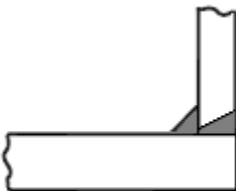

**Abutting/Set-on Nozzle No Pad**

N2 Pulsation damper second stage discharge  
C220006CLC012

Static Calculation

PV Elite 24 SP1 Licensee: PPV-Engineering B.V.

FileName : 2nd-stage Discharge\_LI4736 -----

Nozzle Calcs.: N3 Nozl: 15 9:13am Jun 21, 2022

**Reinforcement CALCULATION, Description: N3**

ASME Code, Section VIII, Div. 1, 2021, UG-37 to UG-45

Actual Outside Diameter Used in Calculation	38.100 mm.
Actual Thickness Used in Calculation	8.382 mm

Nozzle input data check completed without errors.

Reqd thk per UG-37(a) of Cylindrical Shell, tr [Int. Press]

$$= P \cdot R / (S_v \cdot E - 0.6 \cdot P) \text{ per UG-27 (c)(1)}$$

$$= 2.5 \cdot 130.2 / (117.9 \cdot 1 - 0.6 \cdot 2.5)$$

$$= 2.7969 \text{ mm}$$

Reqd thk per UG-37(a) of Nozzle Wall, trn [Int. Press]

$$= P \cdot R_o / (S_n \cdot E + 0.4 \cdot P) \text{ per Appendix 1-1 (a)(1)}$$

$$= 2.5 \cdot 19.05 / (117.9 \cdot 1 + 0.4 \cdot 2.5)$$

$$= 0.4005 \text{ mm}$$

**UG-40, Limits of Reinforcement : [Internal Pressure]**

Parallel to Vessel Wall (Diameter Limit)	D1	54.6720 mm
Parallel to Vessel Wall, opening length	d	27.3360 mm
Normal to Vessel Wall (Thickness Limit), no pad	Tlnp	12.7750 mm

*Taking a UG-36(c)(3)(a) exemption for nozzle: N3.*

*This calculation is valid for nozzles that meet all the requirements of paragraph UG-36. Please check the Code carefully, especially for nozzles that are not isolated or do not meet Code spacing requirements. To force the computation of areas for small nozzles go to Tools->Configuration and check the box to force the UG-37 small nozzle area calculation.*

**UG-45 Minimum Nozzle Neck Thickness Requirement: [Int. Press.]**

Wall Thickness for Internal/External pressures	ta = 3.4005 mm
Wall Thickness per UG16(b),	tr16b = 4.5000 mm
Wall Thickness, shell/head, internal pressure	trb1 = 5.7969 mm
Wall Thickness	tb1 = max(trb1, tr16b) = 5.7969 mm
Wall Thickness	tb2 = max(trb2, tr16b) = 4.5000 mm
Wall Thickness per table UG-45	tb3 = 6.1200 mm

Determine Nozzle Thickness candidate [tb]:

$$= \min[ tb3, \max( tb1, tb2 ) ]$$

$$= \min[ 6.12, \max( 5.797, 4.5 ) ]$$

$$= 5.7969 \text{ mm}$$

Minimum Wall Thickness of Nozzle Necks [tUG-45]:

$$= \max( ta, tb )$$

$$= \max( 3.401, 5.797 )$$

$$= 5.7969 \text{ mm}$$

Available Nozzle Neck Thickness = 8.3820 mm --> OK

**Nozzle Junction Minimum Design Metal Temperature (MDMT) Calculations:**

**Nozzle-Shell/Head Weld (UCS-66(a)1(b)), Curve: B**

Govrn. thk, tg = 8.11, tr = 2.797, c = 3 mm, E\* = 1

Thickness Ratio = tr \* E\*/(tg - c) = 0.547, Temp. Reduction = 27 °C

N2 Pulsation damper second stage discharge

C220006CLC012

Static Calculation

PV Elite 24 SP1 Licensee: PPV-Engineering B.V.

FileName : 2nd-stage Discharge\_LI4736 -----

Nozzle Calcs.: N3 Nozl: 15 9:13am Jun 21,2022

Min Metal Temp. w/o impact per UCS-66, Curve B -29 °C

Min Metal Temp. at Required thickness (UCS 66.1) -48 °C

Gov. MDMT of the nozzle to shell joint welded assembly : -48 °C

Weld Size Calculations, Description: N3

Intermediate Calc. for nozzle/shell Welds Tmin 5.3820 mm

**Results Per UW-16.1:**

	Required Thickness	Actual Thickness
Nozzle Weld	3.7674 = 0.7 * tmin.	4.2420 = 0.7 * Wo mm

Skipping the nozzle attachment weld strength calculations. Per UW-15(b)(2) the nozzles exempted by UG-36(c)(3)(a) (small nozzles) do not require a weld strength check.

**Maximum Allowable Pressure for this Nozzle at this Location:**

Converged Maximum Allowable Pressure in the Operating case: 3.809 MPa

Note: The MAWP of this junction was limited by the parent Shell/Head.

The Drop for this Nozzle is : 1.4343 mm

The Cut Length for this Nozzle is, Drop + Ho + H + T : 57.1692 mm

**PV Elite is a trademark of Hexagon AB, 2022, All rights reserved.**

# Report – N2-Inlet\_LI4734 C220006CLC009

## **PV-Elite Calculation Summary**

Client: Airpack Nederland BV.  
Client location: Zierikzee  
Ref number client: 17811-OO-0702(KP)

### **PPV Engineering**

Author: H.Hoezen  
- Telephone: +31 (0)594 581010  
- E-mail: h.hoezen@ppv-engineering.nl

June 22, 2022  
Order number: P22-115-01  
Document number: 22-11501-C01  
Revision: 1

# Table of Contents

Cover Sheet .....	2
Vessel Design Summary: .....	3
Nozzle Summary: .....	5
Nozzle Schedule: .....	6
Bill of Material: .....	7
Input Echo: .....	8
Internal Pressure Calculations: .....	13
Element and Detail Weights: .....	18
Nozzle Flange MAWP: .....	20
Nozzle Calcs.: N2 .....	21
Nozzle Calcs.: N3 .....	24
Nozzle Calcs.: N1 .....	27

N2 Pulsation damper inlet  
C220006CLC009  
Static Calculation

**DESIGN CALCULATION**

*In Accordance with ASME Section VIII Division 1*

ASME Code Version : 2021

Analysis Performed by : PPV-Engineering B.V.

Job File : ...\\N2-Inlet\_LI4734.pvdb

Date of Analysis : Jun 21,2022 8:26am

**PV Elite 24 SP1, March 2022**

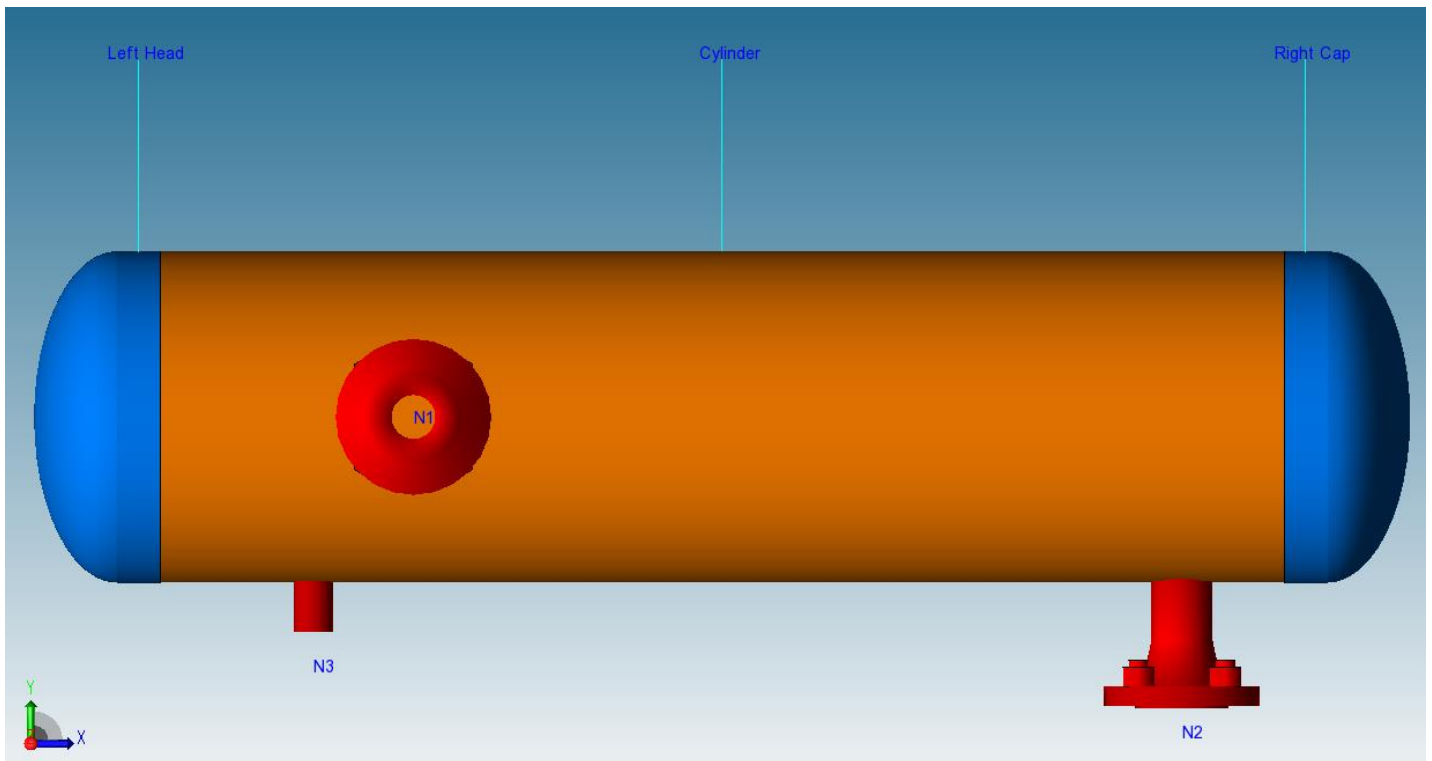

N2 Pulsation damper inlet

C220006CLC009

Static Calculation

PV Elite 24 SP1 Licensee: PPV-Engineering B.V.

FileName : N2-Inlet\_LI4734

Vessel Design Summary:

Step: 15 8:26am Jun 21, 2022

**Vessel Design Summary:****ASME Code, Section VIII Division 1, 2021**

Diameter Spec : 323.800 mm OD  
Vessel Design Length, Tangent to Tangent 1184.63 mm  
Specified Datum Line Distance 42.31 mm  
Internal Design Temperature 85 °C  
Internal Design Pressure 1.250 MPa  
External Design Temperature 85 °C  
Maximum Allowable Working Pressure 1.815 MPa  
Shop Test Pressure 2.550 MPa  
Required Minimum Design Metal Temperature -28.9 °C  
Warmest Computed Minimum Design Metal Temperature -38.0 °C  
Wind Design Code No Wind Loads  
Earthquake Design Code No Seismic

**Materials of Construction:**

Component Type	Material	Class	Thickness	UNS #	Normalized	Impact Tested
Shell	SA-106 B	...	...	K03006	No	No
Head	SA-234 WPB	...	...	K03006	No	No
Nozzle	SA-106 B	...	...	K03006	No	No
Nozzle Flg	SA-105	...	...	K03504	No	No

Normalized is determined based on the UCS-66 material curve selection and Figure UCS-66.  
Impact Tested is based on material selection and material data properties.

**Element Pressures and MAWP (MPa & mm):**

Element Description or Type	Design Pressure + Stat. head	Ext. Press.	Element M.A.W.P	Total Corrosion Allowance	Str. Flg. Gov.	In Creep Range
Left Head	1.250	0.00	3.942	3.0000	Yes	No
Cylinder	1.250	0.00	3.204	3.0000	N/A	No
Right Cap	1.250	0.00	4.107	3.0000	Yes	No

**Element Types and Properties:**

Element Type	"To" Elev mm	Element Length mm	Nominal Thickness mm	Finished Thickness mm	Reqd Thk Internal mm	Reqd Thk External mm	Long Eff	Circ Eff
Ellipse	0.0	42.3	9.3	9.3	4.9	...	0.85	0.85
Cylinder	1100.0	1100.0	9.5	8.1	5.0	...	0.85	0.85
Ellipse	1142.3	42.3	9.5	9.5	4.9	...	0.85	0.85

N2 Pulsation damper inlet

C220006CLC009

Static Calculation

PV Elite 24 SP1 Licensee: PPV-Engineering B.V.

FileName : N2-Inlet\_LI4734 -----

Vessel Design Summary: Step: 15 8:26am Jun 21,2022

**Weights:**

Fabricated - Bare W/O Removable Internals	112.5	kgm
Shop Test - Fabricated + Water ( Full )	207.8	kgm
Shipping - Fab. + Rem. Intls.+ Shipping App.	112.5	kgm
Erected - Fab. + Rem. Intls.+ Insul. (etc)	112.5	kgm
Empty - Fab. + Intls. + Details + Wghts.	112.5	kgm
Operating - Empty + Operating Liquid (No CA)	112.5	kgm
Field Test - Empty Weight + Water (Full)	207.8	kgm

**PV Elite is a trademark of Hexagon AB, 2022, All rights reserved.**

N2 Pulsation damper inlet

C220006CLC009

Static Calculation

PV Elite 24 SP1 Licensee: PPV-Engineering B.V.

FileName : N2-Inlet\_LI4734

Nozzle Summary:

Step: 13 8:26am Jun 21, 2022

### Nozzle Calculation Summary (MPa & mm):

Description	MAWP	Ext	MAPNC	UG-45	[tr]	Weld Path	Areas or Stresses
N2	3.204	...	...	OK	4.66	OK	No Calc[*]
N3	3.204	...	...	OK	4.66	OK	No Calc[*]
N1	3.204	...	...	OK	4.66	OK	No Calc[*]

### Nozzle MAWP Summary:

Minimum MAWP Nozzles : 3.204 Nozzle : N1

Minimum MAWP Shells/Flanges : 1.815 MPa

Computed Vessel M.A.W.P. : 1.815 MPa

[\*] - This was a small opening and the areas were not computed.

Note: MAWPs (Internal Case) shown above are at the High Point.

Multiple output lines for the same nozzle indicates required Code calculations in both the longitudinal and circumferential planes of reinforcement where applicable.

### Check the Spatial Relationship between the Nozzles:

From Node	Nozzle Description	X Coordinate mm	Layout Angle deg	Dia. Limit mm
20	N2	1042.315	270.000	97.700
20	N3	192.315	270.000	54.672
20	N1	290.315	0.000	97.700

### The nozzle spacing is computed by the following:

=  $\sqrt{l^2 + l_c^2}$  where

l - Arc length along the inside vessel surface in the long. direction.

l<sub>c</sub> - Arc length along the inside vessel surface in the circ. direction

If any interferences/violations are found, they will be noted below.

No interference violations have been detected!

PV Elite is a trademark of Hexagon AB, 2022, All rights reserved.

N2 Pulsation damper inlet

C220006CLC009

Static Calculation

PV Elite 24 SP1 Licensee: PPV-Engineering B.V.

FileName : N2-Inlet\_LI4734

Nozzle Schedule: Step: 12 8:26am Jun 21, 2022

**Nozzle Schedule:**

Description	Nominal or Actual Size	Schd or FVC Type	Flg Type	Nozzle O/Dia mm	Wall Thk mm	Reinforcing Diameter	Pad Thk mm	Cut Length mm	Flg Class
N3	38 mm	Actual	None	38.1	8.382	...	...	56	...
N2	50 mm	160	WNF	60.3	8.738	...	...	68	150
N1	50 mm	160	WNF	60.3	8.738	...	...	68	150

General Notes for the above table:

The Cut Length is the Outside Projection + Inside Projection + Drop + In Plane Shell Thickness. This value does not include weld gaps, nor does it account for shrinkage.

In the case of Oblique Nozzles, the Outside Diameter must be increased. The Re-Pad WIDTH around the nozzle is calculated as follows:  
Width of Pad = (Pad Outside Dia. (per above) - Nozzle Outside Dia.)/2

For hub nozzles, the thickness and diameter shown are those of the smaller and thinner section.

**Nozzle Material and Weld Fillet Leg Size Details (mm):**

Description	Material	Shl Grve Weld	Noz Shl/Pad Weld	Pad OD Weld	Pad Grve Weld	Inside Weld
N3	SA-106 B	8.340	6.000	...	...	...
N2	SA-106 B	8.340	6.000	...	...	...
N1	SA-106 B	8.340	6.000	...	...	...

Note: The Outside projections below do not include the flange thickness.

**Nozzle Miscellaneous Data:**

Description	Elev/Distance From Datum mm	Layout Angle deg	Proj Outside mm	Proj Inside mm	Installed in Component
N3	150.000	270.0	47.62	0.00	Cylinder
N2	1000.000	270.0	57.00	0.00	Cylinder
N1	248.000	0.0	57.00	0.00	Cylinder

PV Elite is a trademark of Hexagon AB, 2022, All rights reserved.

N2 Pulsation damper inlet

C220006CLC009

Static Calculation

PV Elite 24 SP1 Licensee: PPV-Engineering B.V.

FileName : N2-Inlet\_LI4734

Bill of Material:

Step: 11 8:26am Jun 21,2022

**Bill of Materials:**

QTY	DESCRIPTION	MATERIAL
1	ELLIPTICAL HEAD: 2.0 X 1, 9.3mm THK X 305.3mm ID X 42.3mm	SA-234 WPB
1	CYLINDER: 9.5mm THK X 307.6mm ID X 1100.0mm	SA-106 B
1	ELLIPTICAL HEAD: 2.0 X 1, 9.5mm THK X 304.8mm ID X 42.3mm	SA-234 WPB
1	NAMEPLATE	...

PV Elite is a trademark of Hexagon AB, 2022, All rights reserved.

N2 Pulsation damper inlet

C220006CLC009

Static Calculation

PV Elite 24 SP1 Licensee: PPV-Engineering B.V.

FileName : N2-Inlet\_LI4734

Input Echo:

Step: 1 8:26am Jun 21, 2022

**Units used in this Analysis (SI\_ASME):**

Name	System Unit	Constant	User Unit
Length	Feet	304.8000	mm
Force	Pounds	4.4480	N
Mass	Pounds	0.4536	kgm
Area	sq. inches	645.1600	mm <sup>2</sup>
Moment	ft. lbs.	1356.3000	N-mm
Stress	lbs./sq.in.	0.0069	MPa
Temperature	Degrees F	0.5556	°C
Pressure	psig	0.0069	MPa
Elast. Modulus	lbs./sq.in.	0.0069	MPa
Pipe Density	lbs./cu.in.	0.0277	kg/cm <sup>3</sup>
Ins. Density	lbs./cu.ft.	0.1602E-04	kg/cm <sup>3</sup>
Fluid Density	lbs./cu.ft.	0.1602E-04	kg/cm <sup>3</sup>
Wind Speed	miles/hr	1.6093	km/hr
Tray Weight	lbs./sq.ft.	0.0005	kg/cm <sup>2</sup>
Inertia	in.**4	416231.0000	mm**4
G Load	G's	1.0000	g's
Wind Load	lbs./sq.ft.	0.0479	kPa
Elevation	Feet	304.8000	mm
Volume	in.**3	0.0164	ltr
Diameter	inches	25.4000	mm
Thickness	inches	25.4000	mm

**PV Elite Vessel Analysis Program: Input Data**

N2 Pulsation damper inlet

C220006CLC009

Static Calculation

Design Internal Pressure (for Hydrotest)	1.25	MPa
Design Internal Temperature	85.0	°C
Projection of Nozzle from Vessel Top	0	mm
Projection of Nozzle from Vessel Bottom	0	mm
Minimum Design Metal Temperature	-28.9	°C
Type of Construction	Welded	
Special Service	None	
Degree of Radiography	RT-3	
Use Higher Longitudinal Stresses (Flag)	Y	
Select t for Internal Pressure (Flag)	N	
Select t for External Pressure (Flag)	N	
Select t for Axial Stress (Flag)	N	
Select Location for Stiff. Rings (Flag)	N	
Consider Vortex Shedding	N	

**Shop Pressure Test:**

Type of Pressure Test	User Entered Pressure
Pressure Test Position	Horizontal

Load Case 1	NP+EW+WI+FW+BW
Load Case 2	NP+EW+EE+FS+BS
Load Case 3	NP+OW+WI+FW+BW
Load Case 4	NP+OW+EQ+FS+BS
Load Case 5	NP+HW+HI
Load Case 6	NP+HW+HE

N2 Pulsation damper inlet

C220006CLC009

Static Calculation

PV Elite 24 SP1 Licensee: PPV-Engineering B.V.

FileName : N2-Inlet\_LI4734

Input Echo: Step: 1 8:26am Jun 21, 2022

Load Case 7	IP+OW+WI+FW+BW
Load Case 8	IP+OW+EQ+FS+BS
Load Case 9	EP+OW+WI+FW+BW
Load Case 10	EP+OW+EQ+FS+BS
Load Case 11	HP+HW+HI
Load Case 12	HP+HW+HE
Load Case 13	IP+WE+EW
Load Case 14	IP+WF+CW
Load Case 15	IP+VO+OW
Load Case 16	IP+VE+EW
Load Case 17	NP+VO+OW
Load Case 18	FS+BS+IP+OW
Load Case 19	FS+BS+EP+OW

Wind Design Code No Wind Loads

Seismic Design Code No Seismic

Design Pressure + Static Head	Y
Consider MAP New and Cold in Noz. Design	N
Consider External Loads for Nozzle Des.	Y
Use ASME VIII-1 Appendix 1-9	N

Perform Blast Load Analysis	No
Material Database Year	Current w/Addenda or Code Year

#### Configuration Directives:

Do not use Nozzle MDMT Interpretation VIII-1 01-37	No
Use Table G instead of exact equation for "A"	Yes
Shell Head Joints are Tapered	Yes
Compute "K" in corroded condition	Yes
Use Code Case 2286	No
Use the MAWP to compute the MDMT	Yes
For thickness ratios $\leq 0.35$ , MDMT will be -155F (-104C)	Yes
For PWHT & P1 Materials the MDMT can be $< -55F (-48C)$	No
Using Metric Material Databases, ASME II D	No
Calculate B31.3 type stress for Nozzles with Loads	Yes
Reduce the MDMT due to lower membrane stress	Yes
Consider Longitudinal Stress in MDMT Calculations	Yes

#### Complete Listing of Vessel Elements and Details:

Element From Node	10
Element To Node	20
Element Type	Elliptical
Description	Left Head
Distance "FROM" to "TO"	42.315 mm
Element Outside Diameter	323.8 mm
Element Thickness	9.27 mm
Internal Corrosion Allowance	3 mm
Nominal Thickness	9.27 mm
External Corrosion Allowance	0 mm
Design Internal Pressure	1.25 MPa
Design Temperature Internal Pressure	85 °C
Design External Pressure	0 MPa
Design Temperature External Pressure	85 °C
Effective Diameter Multiplier	1.2

N2 Pulsation damper inlet  
C220006CLC009

Static Calculation

PV Elite 24 SP1 Licensee: PPV-Engineering B.V.

FileName : N2-Inlet\_LI4734

Input Echo: Step: 1 8:26am Jun 21,2022

Material Name	SA-234 WPB	
Allowable Stress, Ambient	117.9	MPa
Allowable Stress, Operating	117.9	MPa
Allowable Stress, Hydrotest	153.28	MPa
Material Density	0.00775	kg/cm <sup>3</sup>
P Number Thickness	30.988	mm
Yield Stress, Operating	222.99	MPa
UCS-66 Chart Curve Designation	B	
External Pressure Chart Name	CS-2	
UNS Number	K03006	
Product Form	Smls. & wld. fittings	
Efficiency, Longitudinal Seam	0.85	
Efficiency, Circumferential Seam	0.85	
Elliptical Head Factor	2.0	
Weld is pre-Heated	No	

Element From Node	20	
Element To Node	30	
Element Type	Cylinder	
Description	Cylinder	
Distance "FROM" to "TO"	1100	mm
Element Outside Diameter	323.8	mm
Element Thickness	8.11	mm
Internal Corrosion Allowance	3	mm
Nominal Thickness	9.53	mm
External Corrosion Allowance	0	mm
Design Internal Pressure	1.25	MPa
Design Temperature Internal Pressure	85	°C
Design External Pressure	0	MPa
Design Temperature External Pressure	85	°C
Effective Diameter Multiplier	1.2	
Material Name	SA-106 B	
Allowable Stress, Ambient	117.9	MPa
Allowable Stress, Operating	117.9	MPa
Allowable Stress, Hydrotest	153.28	MPa
Material Density	0.00775	kg/cm <sup>3</sup>
P Number Thickness	30.988	mm
Yield Stress, Operating	222.99	MPa
UCS-66 Chart Curve Designation	B	
External Pressure Chart Name	CS-2	
UNS Number	K03006	
Product Form	Smls. pipe	
Efficiency, Longitudinal Seam	0.85	
Efficiency, Circumferential Seam	0.85	
Weld is pre-Heated	No	

Element From Node	20	
Detail Type	Nozzle	
Detail ID	N2	
Dist. from "FROM" Node / Offset dist	1000	mm
Nozzle Diameter	50	mm
Nozzle Schedule	160	
Nozzle Class	150	
Layout Angle	270.0	
Blind Flange (Y/N)	N	
Weight of Nozzle ( Used if > 0 )	0	N
Grade of Attached Flange	GR 1.1	

N2 Pulsation damper inlet

C220006CLC009

Static Calculation

PV Elite 24 SP1 Licensee: PPV-Engineering B.V.

FileName : N2-Inlet\_LI4734

Input Echo:

Step: 1 8:26am Jun 21,2022

```

Nozzle Matl                      SA-106 B

Element From Node                 20
Detail Type                       Nozzle
Detail ID                         N3
Dist. from "FROM" Node / Offset dist 150 mm
Nozzle Diameter                   38.1 mm
Nozzle Schedule                   None
Nozzle Class                      None
Layout Angle                      270.0
Blind Flange (Y/N)               N
Weight of Nozzle ( Used if > 0 )  0 N
Grade of Attached Flange         None
Nozzle Matl                      SA-106 B

Element From Node                 20
Detail Type                       Nozzle
Detail ID                         N1
Dist. from "FROM" Node / Offset dist 248 mm
Nozzle Diameter                   50 mm
Nozzle Schedule                   160
Nozzle Class                      150
Layout Angle                      0.0
Blind Flange (Y/N)               N
Weight of Nozzle ( Used if > 0 )  0 N
Grade of Attached Flange         GR 1.1
Nozzle Matl                      SA-106 B

```

```

-----
Element From Node                 30
Element To Node                   40
Element Type                      Elliptical
Description                       Right Cap
Distance "FROM" to "TO"          42.315 mm
Element Outside Diameter         323.9 mm
Element Thickness                 9.53 mm
Internal Corrosion Allowance      3 mm
Nominal Thickness                 9.53 mm
External Corrosion Allowance      0 mm
Design Internal Pressure          1.25 MPa
Design Temperature Internal Pressure 85 °C
Design External Pressure          0 MPa
Design Temperature External Pressure 85 °C
Effective Diameter Multiplier     1.2
Material Name                     SA-234 WPB
  Allowable Stress, Ambient        117.9 MPa
  Allowable Stress, Operating      117.9 MPa
  Allowable Stress, Hydrotest     153.28 MPa
  Material Density                 0.00775 kg/cm³
  P Number Thickness              30.988 mm
  Yield Stress, Operating          222.99 MPa
  UCS-66 Chart Curve Designation  B
  External Pressure Chart Name     CS-2
  UNS Number                      K03006
  Product Form                    Smls. & wld. fittings
Efficiency, Longitudinal Seam     0.85
Efficiency, Circumferential Seam  0.85
Elliptical Head Factor            2.0

```

N2 Pulsation damper inlet

C220006CLC009

Static Calculation

PV Elite 24 SP1 Licensee: PPV-Engineering B.V.

FileName : N2-Inlet\_LI4734 -----

Input Echo: Step: 1 8:26am Jun 21,2022

Weld is pre-Heated

No

**PV Elite is a trademark of Hexagon AB, 2022, All rights reserved.**

N2 Pulsation damper inlet  
C220006CLC009

Static Calculation

PV Elite 24 SP1 Licensee: PPV-Engineering B.V.

FileName : N2-Inlet\_LI4734

Internal Pressure Calculations: Step: 3 8:26am Jun 21, 2022

### Internal Pressure Results Summary:

#### Element Thickness, Pressure, Diameter and Allowable Stress :

From	To	Int. Press + Liq. Hd MPa	Nominal Thickness mm	Total Corr Allowance mm	Element Diameter mm	Allowable Stress(SE) MPa
Left Head		1.25	9.27	3	323.8	100.22
Cylinder		1.25	9.53	3	323.8	100.22
Right Cap		1.25	9.53	3	323.9	100.22

#### Element Required Thickness and MAWP :

From	To	Design Pressure MPa	M.A.W.P. Corroded MPa	M.A.P. New & Cold MPa	Minimum Thickness mm	Required Thickness mm
Left Head		1.25	3.942	6.05	9.27	4.94764
Cylinder		1.25	3.204	5.123	8.11	5.00931
Right Cap		1.25	4.107	6.227	9.53	4.94817
Minimum			1.815	1.96		

Note : The M.A.W.P is Governed by a Standard Flange !

Note : The M.A.P.(NC) is Governed by a Flange !

Elements Suitable for Design Internal Pressure.

### Internal Pressure Calculation Results:

#### ASME Code, Section VIII Division 1, 2021

#### Elliptical Head From 10 To 20 SA-234 WPB , UCS-66 Crv. B at 85 °C

Left Head

Longitudinal Joint: User Defined

Material UNS Number: K03006

Required Thickness due to Internal Pressure [tr]:

$$\begin{aligned}
 &= (P \cdot D_o \cdot K_{cor}) / (2 \cdot S \cdot E + 2 \cdot P \cdot (K_{cor} - 0.1)) \text{ per Appendix 1-4 (c)} \\
 &= (1.25 \cdot 323.8 \cdot 0.975) / (2 \cdot 117.9 \cdot 0.85 + 2 \cdot 1.25 \cdot (0.975 - 0.1)) \\
 &= 1.9476 + 3.0000 = 4.9476 \text{ mm}
 \end{aligned}$$

Max. Allowable Working Pressure at given Thickness, corroded [MAWP]:

$$\begin{aligned}
 &= (2 \cdot S \cdot E \cdot t) / (K_{cor} \cdot D_o - 2 \cdot t \cdot (K_{cor} - 0.1)) \text{ per Appendix 1-4 (c)} \\
 &= (2 \cdot 117.9 \cdot 0.85 \cdot 6.27) / (0.975 \cdot 323.8 - 2 \cdot 6.27 \cdot (0.975 - 0.1)) \\
 &= 4.124 \text{ MPa}
 \end{aligned}$$

Maximum Allowable Pressure, New and Cold [MAPNC]:

$$\begin{aligned}
 &= (2 \cdot S \cdot E \cdot t) / (K \cdot D_o - 2 \cdot t \cdot (K - 0.1)) \text{ per Appendix 1-4 (c)} \\
 &= (2 \cdot 117.9 \cdot 0.85 \cdot 9.27) / (1 \cdot 323.8 - 2 \cdot 9.27 \cdot (1 - 0.1)) \\
 &= 6.05 \text{ MPa}
 \end{aligned}$$

N2 Pulsation damper inlet

C220006CLC009

Static Calculation

PV Elite 24 SP1 Licensee: PPV-Engineering B.V.

FileName : N2-Inlet\_LI4734

Internal Pressure Calculations: Step: 3 8:26am Jun 21, 2022

Actual stress at given pressure and thickness, corroded [Sact]:

$$\begin{aligned}
 &= (P \cdot (K_{cor} \cdot D_o - 2 \cdot t) \cdot (K_{cor} - 0.1)) / (2 \cdot E \cdot t) \\
 &= (1.25 \cdot (0.975 \cdot 323.8 - 2 \cdot 6.27) \cdot (0.975 - 0.1)) / (2 \cdot 0.85 \cdot 6.27) \\
 &= 35.737 \text{ MPa}
 \end{aligned}$$

Straight Flange Required Thickness:

$$\begin{aligned}
 &= (P \cdot R_o) / (S \cdot E + 0.4 \cdot P) + c_a \text{ per Appendix 1-1 (a)(1)} \\
 &= (1.25 \cdot 161.9) / (117.9 \cdot 0.85 + 0.4 \cdot 1.25) + 3 \\
 &= 5.009 \text{ mm}
 \end{aligned}$$

Straight Flange Maximum Allowable Working Pressure:

$$\begin{aligned}
 &= (S \cdot E \cdot t) / (R_o - 0.4 \cdot t) \text{ per Appendix 1-1 (a)(1)} \\
 &= (117.9 \cdot 0.85 \cdot 6.27) / (161.9 - 0.4 \cdot 6.27) \\
 &= 3.942 \text{ MPa}
 \end{aligned}$$

Factor K, corroded condition [Kcor]:

$$\begin{aligned}
 &= (2 + (\text{Inside Diameter} / (2 \cdot \text{Inside Head Depth}))^2) / 6 \\
 &= (2 + (311.3 / (2 \cdot 79.31))^2) / 6 \\
 &= 0.975023
 \end{aligned}$$

#### MDMT Calculations in the Knuckle Portion:

Govern. thk,  $t_g = 9.27$ ,  $t_r = 2.814$ ,  $c = 3$  mm,  $E^* = 0.85$

Thickness Ratio =  $t_r \cdot E^* / (t_g - c) = 0.382$ , Temp. Reduction = 56 °C

Min Metal Temp. w/o impact per UCS-66, Curve B -29 °C  
 Min Metal Temp. at Required thickness (UCS 66.1) -48 °C

#### MDMT Calculations in the Head Straight Flange:

Govern. thk,  $t_g = 9.27$ ,  $t_r = 2.911$ ,  $c = 3$  mm,  $E^* = 0.85$

Thickness Ratio =  $t_r \cdot E^* / (t_g - c) = 0.395$ , Temp. Reduction = 52 °C

Min Metal Temp. w/o impact per UCS-66, Curve B -29 °C  
 Min Metal Temp. at Required thickness (UCS 66.1) -48 °C

#### Cylindrical Shell From 20 To 30 SA-106 B , UCS-66 Crv. B at 85 °C

Cylinder

Longitudinal Joint: Spot Radiography per UW-11(b) Type 1

Material UNS Number: K03006

Required Thickness due to Internal Pressure [tr]:

$$\begin{aligned}
 &= (P \cdot R_o) / (S \cdot E + 0.4 \cdot P) \text{ per Appendix 1-1 (a)(1)} \\
 &= (1.25 \cdot 161.9) / (117.9 \cdot 0.85 + 0.4 \cdot 1.25) \\
 &= 2.0093 + 3.0000 = 5.0093 \text{ mm}
 \end{aligned}$$

Max. Allowable Working Pressure at given Thickness, corroded [MAWP]:

$$\begin{aligned}
 &= (S \cdot E \cdot t) / (R_o - 0.4 \cdot t) \text{ per Appendix 1-1 (a)(1)} \\
 &= (117.9 \cdot 0.85 \cdot 5.11) / (161.9 - 0.4 \cdot 5.11) \\
 &= 3.204 \text{ MPa}
 \end{aligned}$$

Maximum Allowable Pressure, New and Cold [MAPNC]:

$$\begin{aligned}
 &= (S \cdot E \cdot t) / (R_o - 0.4 \cdot t) \text{ per Appendix 1-1 (a)(1)} \\
 &= (117.9 \cdot 0.85 \cdot 8.11) / (161.9 - 0.4 \cdot 8.11) \\
 &= 5.123 \text{ MPa}
 \end{aligned}$$

N2 Pulsation damper inlet

C220006CLC009

Static Calculation

PV Elite 24 SP1 Licensee: PPV-Engineering B.V.

FileName : N2-Inlet\_LI4734

Internal Pressure Calculations: Step: 3 8:26am Jun 21, 2022

Actual stress at given pressure and thickness, corroded [Sact]:

$$\begin{aligned}
 &= (P \cdot (R_o - 0.4 \cdot t)) / (E \cdot t) \\
 &= (1.25 \cdot ((161.9 - 0.4 \cdot 5.11)) / (0.85 \cdot 5.11)) \\
 &= 46.004 \text{ MPa}
 \end{aligned}$$

**Minimum Design Metal Temperature Results:**

Govrn. thk, tg = 8.11, tr = 1.415, c = 3 mm, E\* = 0.85

Thickness Ratio = tr \* E\*/(tg - c) = 0.235, Temp. Reduction = 78 °C

Min Metal Temp. w/o impact per UCS-66, Curve B -29 °C

Min Metal Temp. at Required thickness (UCS 66.1) -104 °C

**Elliptical Head From 30 To 40 SA-234 WPB, UCS-66 Crv. B at 85 °C**

Right Cap

Longitudinal Joint: User Defined

Material UNS Number: K03006

Required Thickness due to Internal Pressure [tr]:

$$\begin{aligned}
 &= (P \cdot D_o \cdot K_{cor}) / (2 \cdot S \cdot E + 2 \cdot P \cdot (K_{cor} - 0.1)) \text{ per Appendix 1-4 (c)} \\
 &= (1.25 \cdot 323.9 \cdot 0.975) / (2 \cdot 117.9 \cdot 0.85 + 2 \cdot 1.25 \cdot (0.975 - 0.1)) \\
 &= 1.9482 + 3.0000 = 4.9482 \text{ mm}
 \end{aligned}$$

Max. Allowable Working Pressure at given Thickness, corroded [MAWP]:

$$\begin{aligned}
 &= (2 \cdot S \cdot E \cdot t) / (K_{cor} \cdot D_o - 2 \cdot t \cdot (K_{cor} - 0.1)) \text{ per Appendix 1-4 (c)} \\
 &= (2 \cdot 117.9 \cdot 0.85 \cdot 6.53) / (0.975 \cdot 323.9 - 2 \cdot 6.53 \cdot (0.975 - 0.1)) \\
 &= 4.3 \text{ MPa}
 \end{aligned}$$

Maximum Allowable Pressure, New and Cold [MAPNC]:

$$\begin{aligned}
 &= (2 \cdot S \cdot E \cdot t) / (K \cdot D_o - 2 \cdot t \cdot (K - 0.1)) \text{ per Appendix 1-4 (c)} \\
 &= (2 \cdot 117.9 \cdot 0.85 \cdot 9.53) / (1 \cdot 323.9 - 2 \cdot 9.53 \cdot (1 - 0.1)) \\
 &= 6.227 \text{ MPa}
 \end{aligned}$$

Actual stress at given pressure and thickness, corroded [Sact]:

$$\begin{aligned}
 &= (P \cdot (K_{cor} \cdot D_o - 2 \cdot t \cdot (K_{cor} - 0.1))) / (2 \cdot E \cdot t) \\
 &= (1.25 \cdot (0.975 \cdot 323.9 - 2 \cdot 6.53 \cdot (0.975 - 0.1))) / (2 \cdot 0.85 \cdot 6.53) \\
 &= 34.273 \text{ MPa}
 \end{aligned}$$

Straight Flange Required Thickness:

$$\begin{aligned}
 &= (P \cdot R_o) / (S \cdot E + 0.4 \cdot P) + c_a \text{ per Appendix 1-1 (a)(1)} \\
 &= (1.25 \cdot 161.9) / (117.9 \cdot 0.85 + 0.4 \cdot 1.25) + 3 \\
 &= 5.010 \text{ mm}
 \end{aligned}$$

Straight Flange Maximum Allowable Working Pressure:

$$\begin{aligned}
 &= (S \cdot E \cdot t) / (R_o - 0.4 \cdot t) \text{ per Appendix 1-1 (a)(1)} \\
 &= (117.9 \cdot 0.85 \cdot 6.53) / (161.9 - 0.4 \cdot 6.53) \\
 &= 4.107 \text{ MPa}
 \end{aligned}$$

Factor K, corroded condition [Kcor]:

$$\begin{aligned}
 &= (2 + (\text{Inside Diameter} / (2 \cdot \text{Inside Head Depth}))^2) / 6 \\
 &= (2 + (310.8 / (2 \cdot 79.21))^2) / 6 \\
 &= 0.974990
 \end{aligned}$$

**MDMT Calculations in the Knuckle Portion:**

Govrn. thk, tg = 9.53, tr = 2.815, c = 3 mm, E\* = 0.85

N2 Pulsation damper inlet

C220006CLC009

Static Calculation

PV Elite 24 SP1 Licensee: PPV-Engineering B.V.

FileName : N2-Inlet\_LI4734

Internal Pressure Calculations: Step: 3 8:26am Jun 21, 2022

Thickness Ratio =  $tr * E^*/(tg - c) = 0.366$ , Temp. Reduction = 66 °C

Min Metal Temp. w/o impact per UCS-66, Curve B -29 °C

Min Metal Temp. at Required thickness (UCS 66.1) -48 °C

**MDMT Calculations in the Head Straight Flange:**

Govrn. thk,  $tg = 9.53$ ,  $tr = 2.912$ ,  $c = 3$  mm,  $E^* = 0.85$

Thickness Ratio =  $tr * E^*/(tg - c) = 0.379$ , Temp. Reduction = 56 °C

Min Metal Temp. w/o impact per UCS-66, Curve B -29 °C

Min Metal Temp. at Required thickness (UCS 66.1) -48 °C

Note: Heads and Shells Exempted to -20F (-29C) by paragraph UG-20F

**Hydrostatic Test Pressure Results:**

Pressure per UG99b	= 1.30 * M.A.W.P. * Sa/S	2.360 MPa
Pressure per UG99b[35]	= 1.30 * Design Pres * Sa/S	1.625 MPa
Pressure per UG99c	= 1.30 * M.A.P. - Head(Hyd)	2.548 MPa
Pressure per UG100	= 1.10 * M.A.W.P. * Sa/S	1.997 MPa
Pressure per PED	= max(1.43*DP, 1.25*DP*ratio)	1.787 MPa
Pressure per App 27-4	= M.A.W.P.	1.815 MPa

User Defined Hydrostatic Test Pressure at High Point 2.550 MPa

**Horizontal Test performed per: User Hydro Pressure**

Please note that Nozzle, Shell, Head, Flange, etc MAWPs are all considered when determining the hydrotest pressure for those test types that are based on the MAWP of the vessel.

**Stresses on Elements due to Test Pressure (MPa):**

From To	Stress	Allowable	Ratio	Pressure
Left Head	49.8	153.3	0.325	2.55
Cylinder	58.8	153.3	0.383	2.55
Right Cap	48.3	153.3	0.315	2.55

**Stress ratios for Nozzle and Pad Materials (MPa):**

Description	Pad/Nozzle	Ambient	Operating	Ratio
N2	Nozzle	117.90	117.90	1.000
N3	Nozzle	117.90	117.90	1.000
N1	Nozzle	117.90	117.90	1.000
Minimum				1.000

**Stress ratios for Pressurized Vessel Elements (MPa):**

Description	Ambient	Operating	Ratio
Left Head	117.90	117.90	1.000
Cylinder	117.90	117.90	1.000
Right Cap	117.90	117.90	1.000

N2 Pulsation damper inlet

C220006CLC009

Static Calculation

PV Elite 24 SP1 Licensee: PPV-Engineering B.V.

FileName : N2-Inlet\_LI4734 -----

Internal Pressure Calculations: Step: 3 8:26am Jun 21,2022

-----  
 Minimum 1.000

**Hoop Stress in Nozzle Wall during Pressure Test (MPa):**

Description	Ambient	Operating	Ratio
N2	7.79	153.28	0.051
N3	4.78	153.28	0.031
N1	7.79	153.28	0.051

Elements Suitable for Test Pressure.

PV Elite is a trademark of Hexagon AB, 2022, All rights reserved.

N2 Pulsation damper inlet  
C220006CLC009

Static Calculation

PV Elite 24 SP1 Licensee: PPV-Engineering B.V.

FileName : N2-Inlet\_LI4734

Element and Detail Weights: Step: 5 8:26am Jun 21, 2022

**Element and Detail Weights:**

From	To	Element Metal Wgt. kgm	Element ID Volume ltr	Corroded Metal Wgt. kgm	Corroded ID Volume ltr	Extra due Misc %
10	20	11.5111	6.82157	7.78581	7.16848	...
20	30	80.9422	81.7479	55.9867	84.9683	...
30	40	11.8235	6.79771	8.10149	7.14383	...
Total		104	95.37	71	99.28	0

**Weight of Details:**

From	Type	Weight of Detail kgm	X Offset, Dtl. Cent. mm	Y Offset, Dtl. Cent. mm	Z Offset, Dtl. Cent. mm	Description
20	Noz1	3.95534	1000	-183.952	...	N2
20	Noz1	0.28886	150	-172.84	...	N3
20	Noz1	3.95534	248	...	183.952	N1

**Total Weight of Each Detail Type:**

Nozzles	8.2
Sum of the Detail Weights	8.2 kgm

**Weight Summation Results: (kgm)**

	Fabricated	Shop Test	Shipping	Erected	Empty	Operating
Main Elements	104.3	104.3	104.3	104.3	104.3	104.3
Nozzles	8.2	8.2	8.2	8.2	8.2	8.2
Test Liquid	...	95.3	...	...	...	...
Totals	112.5	207.8	112.5	112.5	112.5	112.5

**Weight Summary:**

Fabricated Wt.	- Bare Weight without Removable Internals	112.5 kgm
Shop Test Wt.	- Fabricated Weight + Water ( Full )	207.8 kgm
Shipping Wt.	- Fab. Weight + removable Intls.+ Shipping App.	112.5 kgm
Erected Wt.	- Fab. Wt + or - loose items (trays,platforms etc.)	112.5 kgm
Ope. Wt. no Liq	- Fab. Weight + Internals. + Details + Weights	112.5 kgm
Operating Wt.	- Empty Weight + Operating Liq. Uncorroded	112.5 kgm
Oper. Wt. + CA	- Corr Wt. + Operating Liquid	80.1 kgm
Field Test Wt.	- Empty Weight + Water (Full)	207.8 kgm

Note:

The Corroded Weight and thickness are used in the Horizontal Vessel Analysis (Ope Case) and Earthquake Load Calculations.

**Outside Surface Areas of Elements:**

From	To	Surface Area
------	----	--------------

N2 Pulsation damper inlet

C220006CLC009

Static Calculation

PV Elite 24 SP1 Licensee: PPV-Engineering B.V.

FileName : N2-Inlet\_LI4734

Element and Detail Weights: Step: 5 8:26am Jun 21,2022

		mm <sup>2</sup>
10	20	156697
20	30	1128786
30	40	156780
Total		1442264.125 mm <sup>2</sup>

PV Elite is a trademark of Hexagon AB, 2022, All rights reserved.

N2 Pulsation damper inlet

C220006CLC009

Static Calculation

PV Elite 24 SP1 Licensee: PPV-Engineering B.V.

FileName : N2-Inlet\_LI4734

Nozzle Flange MAWP: Step: 6 8:26am Jun 21,2022

**Nozzle Flange MAWP Results: (MPa & °C)**

Nozzle Description	Flange Rating		Design Temp	Class	Grade/Group	Equiv. Press	Max Pressure		
	Op.	Ambient					UG-44(b)	50%	DNV
N2	1.82	1.96	85	150	GR 1.1	...	...	...	...
N1	1.82	1.96	85	150	GR 1.1	...	...	...	...
Min Rating	1.815	1.960 MPa [for Core Elements]					...	...	...

Pressure Ratings are per ASME B16.5 2017 Metric Edition

PV Elite is a trademark of Hexagon AB, 2022, All rights reserved.

N2 Pulsation damper inlet  
C220006CLC009

Static Calculation

PV Elite 24 SP1 Licensee: PPV-Engineering B.V.

FileName : N2-Inlet\_LI4734

Nozzle Calcs.: N2

-----  
Nozl: 13 8:26am Jun 21, 2022

**Input, Nozzle Desc: N2**

**From: 20**

Pressure for Reinforcement Calculations	P	1.2500	MPa
Temperature for Internal Pressure	Temp	85	°C
Parent Material		SA-106 B	
Parent Allowable Stress at Temperature	Sv	117.90	MPa
Parent Allowable Stress At Ambient	Sva	117.90	MPa
Inside Diameter of Cylindrical Shell	D	304.74	mm
Shell Finished (Minimum) Thickness	t	8.1100	mm
Shell Internal Corrosion Allowance	c	3.0000	mm
Shell External Corrosion Allowance	co	0.0000	mm
Distance from Bottom/Left Tangent		1042.31	mm
User Entered Minimum Design Metal Temperature		-28.89	°C

**Type of Element Connected to the Parent : Nozzle**

Material		SA-106 B	
Material UNS Number		K03006	
Material Specification/Type		Smls. pipe	
Allowable Stress at Temperature	Sn	117.90	MPa
Allowable Stress At Ambient	Sna	117.90	MPa
Diameter Basis (for tr calc only)		Outside	
Layout Angle		270.00	deg
Diameter		50.0000	mm
Size and Thickness Basis		Nominal	
Nominal Thickness		160	
Flange Material		SA-105	
Flange Type		Weld Neck Flange	
Corrosion Allowance	can	3.0000	mm
Joint Efficiency of Shell Seam at Nozzle	E1	1.00	
Joint Efficiency of Nozzle Neck	En	1.00	
Outside Projection	ho	57.0000	mm
Weld leg size between Nozzle and Pad/Shell	Wo	6.0000	mm
Groove weld depth between Nozzle and Vessel Wgnv		8.3400	mm
Flange Class		150	
Flange Grade		GR 1.1	

The Pressure Design option was Design Pressure + static head.

**Nozzle Sketch (may not represent actual weld type/configuration)**

N2 Pulsation damper inlet

C220006CLC009

Static Calculation

PV Elite 24 SP1 Licensee: PPV-Engineering B.V.

FileName : N2-Inlet\_LI4734

Nozzle Calcs.: N2

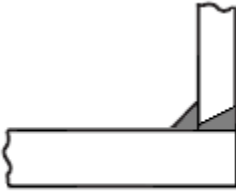
-----  
Nozl: 13 8:26am Jun 21,2022**Abutting/Set-on Nozzle No Pad****Reinforcement CALCULATION, Description: N2**

ASME Code, Section VIII, Div. 1, 2021, UG-37 to UG-45

Actual Outside Diameter Used in Calculation	60.325 mm.
Actual Thickness Used in Calculation	8.738 mm

Nozzle input data check completed without errors.

Reqd thk per UG-37(a) of Cylindrical Shell, tr [Int. Press]

$$= P \cdot R_o / (S_v \cdot E - 0.6 \cdot P) \text{ per UG-27 (c)(1)}$$

$$= 1.25 \cdot 155.4 / (117.9 \cdot 1 - 0.6 \cdot 1.25)$$

$$= 1.6577 \text{ mm}$$

Reqd thk per UG-37(a) of Nozzle Wall, trn [Int. Press]

$$= P \cdot R_o / (S_n \cdot E + 0.4 \cdot P) \text{ per Appendix 1-1 (a)(1)}$$

$$= 1.25 \cdot 30.16 / (117.9 \cdot 1 + 0.4 \cdot 1.25)$$

$$= 0.3184 \text{ mm}$$

**UG-40, Limits of Reinforcement : [Internal Pressure]**

Parallel to Vessel Wall (Diameter Limit)	D1	97.6996 mm
Parallel to Vessel Wall, opening length	d	48.8498 mm
Normal to Vessel Wall (Thickness Limit), no pad	Tlnp	12.7750 mm

*Taking a UG-36(c)(3)(a) exemption for nozzle: N2.*

*This calculation is valid for nozzles that meet all the requirements of paragraph UG-36. Please check the Code carefully, especially for nozzles that are not isolated or do not meet Code spacing requirements. To force the computation of areas for small nozzles go to Tools->Configuration and check the box to force the UG-37 small nozzle area calculation.*

**UG-45 Minimum Nozzle Neck Thickness Requirement: [Int. Press.]**

Wall Thickness for Internal/External pressures	ta	= 3.3184 mm
Wall Thickness per UG16(b),	tr16b	= 4.5000 mm
Wall Thickness, shell/head, internal pressure	trb1	= 4.6577 mm
Wall Thickness	tb1 = max(trb1, tr16b)	= 4.6577 mm
Wall Thickness	tb2 = max(trb2, tr16b)	= 4.5000 mm
Wall Thickness per table UG-45	tb3	= 6.4200 mm

Determine Nozzle Thickness candidate [tb]:

$$= \min[ tb3, \max( tb1, tb2 ) ]$$

$$= \min[ 6.42, \max( 4.658, 4.5 ) ]$$

$$= 4.6577 \text{ mm}$$

Minimum Wall Thickness of Nozzle Necks [tUG-45]:

$$= \max( ta, tb )$$

N2 Pulsation damper inlet

C220006CLC009

Static Calculation

PV Elite 24 SP1 Licensee: PPV-Engineering B.V.

FileName : N2-Inlet\_LI4734

Nozzle Calcs.: N2

Noz1: 13 8:26am Jun 21, 2022

$$= \max( 3.318, 4.658 )$$

$$= 4.6577 \text{ mm}$$

Available Nozzle Neck Thickness =  $0.875 * 8.738 = 7.645 \text{ mm}$  --> OK

### Nozzle Junction Minimum Design Metal Temperature (MDMT) Calculations:

#### Nozzle Neck to Flange Weld, min( Curve:B, Curve:A)

Govrn. thk, tg = 7.645, tr = 0.318, c = 3 mm, E\* = 1

Thickness Ratio =  $tr * E*/(tg - c) = 0.0685$ , Temp. Reduction = 78 °C

Min Metal Temp. w/o impact per UCS-66, Curve A -8 °C

Min Metal Temp. at Required thickness (UCS 66.1) -104 °C

Min Metal Temp. w/o impact per UG-20(f) -29 °C

#### Nozzle-Shell/Head Weld (UCS-66(a)1(b)), Curve: B

Govrn. thk, tg = 7.645, tr = 0.318, c = 3 mm, E\* = 1

Thickness Ratio =  $tr * E*/(tg - c) = 0.0685$ , Temp. Reduction = 78 °C

Min Metal Temp. w/o impact per UCS-66, Curve B -29 °C

Min Metal Temp. at Required thickness (UCS 66.1) -104 °C

Gov. MDMT of the nozzle to shell joint welded assembly : -104 °C

#### Flange MDMT including Temperature reduction per UCS-66.1:

Unadjusted MDMT of ASME B16.5/47 flanges per UCS-66(c) -18 °C

Flange MDMT with Temp reduction per UCS-66(b)(1)(-b) -38 °C

Where the Stress Reduction Ratio per UCS-66(b)(1)(-b) is :

$$\text{Design Pressure/Ambient Rating} = 1.25/1.96 = 0.638$$

#### Weld Size Calculations, Description: N2

Intermediate Calc. for nozzle/shell Welds Tmin 5.7376 mm

#### Results Per UW-16.1:

	Required Thickness	Actual Thickness
Nozzle Weld	$4.0163 = 0.7 * t_{min}$	$4.2420 = 0.7 * W_o$ mm

Skipping the nozzle attachment weld strength calculations. Per UW-15(b)(2) the nozzles exempted by UG-36(c)(3)(a) (small nozzles) do not require a weld strength check.

#### Maximum Allowable Pressure for this Nozzle at this Location:

Converged Maximum Allowable Pressure in the Operating case: 3.204 MPa

Note: The MAWP of this junction was limited by the parent Shell/Head.

The Drop for this Nozzle is : 3.0153 mm

The Cut Length for this Nozzle is, Drop + Ho + H + T : 68.1253 mm

PV Elite is a trademark of Hexagon AB, 2022, All rights reserved.

N2 Pulsation damper inlet

C220006CLC009

Static Calculation

PV Elite 24 SP1 Licensee: PPV-Engineering B.V.

FileName : N2-Inlet\_LI4734

Nozzle Calcs.: N3 Nozl: 14 8:26am Jun 21,2022

**Input, Nozzle Desc: N3****From: 20**

Pressure for Reinforcement Calculations	P	1.2500	MPa
Temperature for Internal Pressure	Temp	85	°C
Parent Material		SA-106 B	
Parent Allowable Stress at Temperature	Sv	117.90	MPa
Parent Allowable Stress At Ambient	Sva	117.90	MPa
Inside Diameter of Cylindrical Shell	D	304.74	mm
Shell Finished (Minimum) Thickness	t	8.1100	mm
Shell Internal Corrosion Allowance	c	3.0000	mm
Shell External Corrosion Allowance	co	0.0000	mm
Distance from Bottom/Left Tangent		192.32	mm
User Entered Minimum Design Metal Temperature		-28.89	°C

**Type of Element Connected to the Parent : Nozzle**

Material		SA-106 B	
Material UNS Number		K03006	
Material Specification/Type		Smls. pipe	
Allowable Stress at Temperature	Sn	117.90	MPa
Allowable Stress At Ambient	Sna	117.90	MPa
Diameter Basis (for tr calc only)		Outside	
Layout Angle		270.00	deg
Diameter		38.1000	mm
Size and Thickness Basis		Actual	
Actual Thickness	tn	8.3820	mm
Corrosion Allowance	can	3.0000	mm
Joint Efficiency of Shell Seam at Nozzle	E1	1.00	
Joint Efficiency of Nozzle Neck	En	1.00	
Outside Projection	ho	47.6250	mm
Weld leg size between Nozzle and Pad/Shell	Wo	6.0000	mm
Groove weld depth between Nozzle and Vessel Wgnv		8.3400	mm

The Pressure Design option was Design Pressure + static head.

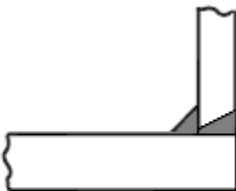
**Nozzle Sketch (may not represent actual weld type/configuration)****Abutting/Set-on Nozzle No Pad**

N2 Pulsation damper inlet  
C220006CLC009

Static Calculation

PV Elite 24 SP1 Licensee: PPV-Engineering B.V.

FileName : N2-Inlet\_LI4734

Nozzle Calcs.: N3

Noz1: 14 8:26am Jun 21, 2022

### Reinforcement CALCULATION, Description: N3

ASME Code, Section VIII, Div. 1, 2021, UG-37 to UG-45

Actual Outside Diameter Used in Calculation	38.100 mm.
Actual Thickness Used in Calculation	8.382 mm

Nozzle input data check completed without errors.

Reqd thk per UG-37(a) of Cylindrical Shell, tr [Int. Press]

$$= P \cdot R / (S_v \cdot E - 0.6 \cdot P) \text{ per UG-27 (c)(1)}$$

$$= 1.25 \cdot 155.4 / (117.9 \cdot 1 - 0.6 \cdot 1.25)$$

$$= 1.6577 \text{ mm}$$

Reqd thk per UG-37(a) of Nozzle Wall, trn [Int. Press]

$$= P \cdot R_o / (S_n \cdot E + 0.4 \cdot P) \text{ per Appendix 1-1 (a)(1)}$$

$$= 1.25 \cdot 19.05 / (117.9 \cdot 1 + 0.4 \cdot 1.25)$$

$$= 0.2011 \text{ mm}$$

### UG-40, Limits of Reinforcement : [Internal Pressure]

Parallel to Vessel Wall (Diameter Limit)	D1	54.6720 mm
Parallel to Vessel Wall, opening length	d	27.3360 mm
Normal to Vessel Wall (Thickness Limit), no pad	Tlnp	12.7750 mm

*Taking a UG-36(c)(3)(a) exemption for nozzle: N3.*

*This calculation is valid for nozzles that meet all the requirements of paragraph UG-36. Please check the Code carefully, especially for nozzles that are not isolated or do not meet Code spacing requirements. To force the computation of areas for small nozzles go to Tools->Configuration and check the box to force the UG-37 small nozzle area calculation.*

### UG-45 Minimum Nozzle Neck Thickness Requirement: [Int. Press.]

Wall Thickness for Internal/External pressures	ta = 3.2011 mm
Wall Thickness per UG16(b),	tr16b = 4.5000 mm
Wall Thickness, shell/head, internal pressure	trb1 = 4.6577 mm
Wall Thickness	tb1 = max(trb1, tr16b) = 4.6577 mm
Wall Thickness	tb2 = max(trb2, tr16b) = 4.5000 mm
Wall Thickness per table UG-45	tb3 = 6.1200 mm

Determine Nozzle Thickness candidate [tb]:

$$= \min[ tb3, \max( tb1, tb2 ) ]$$

$$= \min[ 6.12, \max( 4.658, 4.5 ) ]$$

$$= 4.6577 \text{ mm}$$

Minimum Wall Thickness of Nozzle Necks [tUG-45]:

$$= \max( ta, tb )$$

$$= \max( 3.201, 4.658 )$$

$$= 4.6577 \text{ mm}$$

Available Nozzle Neck Thickness = 8.3820 mm --> OK

### Nozzle Junction Minimum Design Metal Temperature (MDMT) Calculations:

#### Nozzle-Shell/Head Weld (UCS-66(a)1(b)), Curve: B

Govrn. thk, tg = 8.11, tr = 1.658, c = 3 mm, E\* = 1

Thickness Ratio =  $tr \cdot E^* / (tg - c) = 0.324$ , Temp. Reduction = 78 °C

N2 Pulsation damper inlet

C220006CLC009

Static Calculation

PV Elite 24 SP1 Licensee: PPV-Engineering B.V.

FileName : N2-Inlet\_LI4734

Nozzle Calcs.: N3 Nozl: 14 8:26am Jun 21, 2022

Min Metal Temp. w/o impact per UCS-66, Curve B -29 °C

Min Metal Temp. at Required thickness (UCS 66.1) -104 °C

Gov. MDMT of the nozzle to shell joint welded assembly : -104 °C

Weld Size Calculations, Description: N3

Intermediate Calc. for nozzle/shell Welds Tmin 5.3820 mm

**Results Per UW-16.1:**

	Required Thickness	Actual Thickness
Nozzle Weld	3.7674 = 0.7 * tmin.	4.2420 = 0.7 * Wo mm

Skipping the nozzle attachment weld strength calculations. Per UW-15(b)(2) the nozzles exempted by UG-36(c)(3)(a) (small nozzles) do not require a weld strength check.

**Maximum Allowable Pressure for this Nozzle at this Location:**

Converged Maximum Allowable Pressure in the Operating case: 3.204 MPa

Note: The MAWP of this junction was limited by the parent Shell/Head.

The Drop for this Nozzle is : 1.1956 mm

The Cut Length for this Nozzle is, Drop + Ho + H + T : 56.9305 mm

**PV Elite is a trademark of Hexagon AB, 2022, All rights reserved.**

N2 Pulsation damper inlet

C220006CLC009

Static Calculation

PV Elite 24 SP1 Licensee: PPV-Engineering B.V.

FileName : N2-Inlet\_LI4734

Nozzle Calcs.: N1

Nozl: 15 8:26am Jun 21,2022

**Input, Nozzle Desc: N1****From: 20**

Pressure for Reinforcement Calculations	P	1.2500	MPa
Temperature for Internal Pressure	Temp	85	°C
Parent Material		SA-106 B	
Parent Allowable Stress at Temperature	Sv	117.90	MPa
Parent Allowable Stress At Ambient	Sva	117.90	MPa
Inside Diameter of Cylindrical Shell	D	304.74	mm
Shell Finished (Minimum) Thickness	t	8.1100	mm
Shell Internal Corrosion Allowance	c	3.0000	mm
Shell External Corrosion Allowance	co	0.0000	mm
Distance from Bottom/Left Tangent		290.32	mm
User Entered Minimum Design Metal Temperature		-28.89	°C

**Type of Element Connected to the Parent : Nozzle**

Material		SA-106 B	
Material UNS Number		K03006	
Material Specification/Type		Smls. pipe	
Allowable Stress at Temperature	Sn	117.90	MPa
Allowable Stress At Ambient	Sna	117.90	MPa
Diameter Basis (for tr calc only)		Outside	
Layout Angle		0.00	deg
Diameter		50.0000	mm
Size and Thickness Basis		Nominal	
Nominal Thickness		160	
Flange Material		SA-105	
Flange Type		Weld Neck Flange	
Corrosion Allowance	can	3.0000	mm
Joint Efficiency of Shell Seam at Nozzle	E1	1.00	
Joint Efficiency of Nozzle Neck	En	1.00	
Outside Projection	ho	57.0000	mm
Weld leg size between Nozzle and Pad/Shell	Wo	6.0000	mm
Groove weld depth between Nozzle and Vessel Wgnv		8.3400	mm
Flange Class		150	
Flange Grade		GR 1.1	

The Pressure Design option was Design Pressure + static head.

**Nozzle Sketch (may not represent actual weld type/configuration)**

N2 Pulsation damper inlet

C220006CLC009

Static Calculation

PV Elite 24 SP1 Licensee: PPV-Engineering B.V.

FileName : N2-Inlet\_LI4734

Nozzle Calcs.: N1

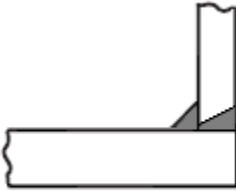
-----  
Nozl: 15 8:26am Jun 21,2022**Abutting/Set-on Nozzle No Pad****Reinforcement CALCULATION, Description: N1**

ASME Code, Section VIII, Div. 1, 2021, UG-37 to UG-45

Actual Outside Diameter Used in Calculation	60.325 mm.
Actual Thickness Used in Calculation	8.738 mm

Nozzle input data check completed without errors.

Reqd thk per UG-37(a) of Cylindrical Shell, tr [Int. Press]

$$= P \cdot R_o / (S_v \cdot E - 0.6 \cdot P) \text{ per UG-27 (c)(1)}$$

$$= 1.25 \cdot 155.4 / (117.9 \cdot 1 - 0.6 \cdot 1.25)$$

$$= 1.6577 \text{ mm}$$

Reqd thk per UG-37(a) of Nozzle Wall, trn [Int. Press]

$$= P \cdot R_o / (S_n \cdot E + 0.4 \cdot P) \text{ per Appendix 1-1 (a)(1)}$$

$$= 1.25 \cdot 30.16 / (117.9 \cdot 1 + 0.4 \cdot 1.25)$$

$$= 0.3184 \text{ mm}$$

**UG-40, Limits of Reinforcement : [Internal Pressure]**

Parallel to Vessel Wall (Diameter Limit)	D1	97.6996 mm
Parallel to Vessel Wall, opening length	d	48.8498 mm
Normal to Vessel Wall (Thickness Limit), no pad	Tlnp	12.7750 mm

*Taking a UG-36(c)(3)(a) exemption for nozzle: N1.*

*This calculation is valid for nozzles that meet all the requirements of paragraph UG-36. Please check the Code carefully, especially for nozzles that are not isolated or do not meet Code spacing requirements. To force the computation of areas for small nozzles go to Tools->Configuration and check the box to force the UG-37 small nozzle area calculation.*

**UG-45 Minimum Nozzle Neck Thickness Requirement: [Int. Press.]**

Wall Thickness for Internal/External pressures	ta = 3.3184 mm
Wall Thickness per UG16(b),	tr16b = 4.5000 mm
Wall Thickness, shell/head, internal pressure	trb1 = 4.6577 mm
Wall Thickness	tb1 = max(trb1, tr16b) = 4.6577 mm
Wall Thickness	tb2 = max(trb2, tr16b) = 4.5000 mm
Wall Thickness per table UG-45	tb3 = 6.4200 mm

Determine Nozzle Thickness candidate [tb]:

$$= \min[ tb3, \max( tb1, tb2 ) ]$$

$$= \min[ 6.42, \max( 4.658, 4.5 ) ]$$

$$= 4.6577 \text{ mm}$$

Minimum Wall Thickness of Nozzle Necks [tUG-45]:

$$= \max( ta, tb )$$

N2 Pulsation damper inlet

C220006CLC009

Static Calculation

PV Elite 24 SP1 Licensee: PPV-Engineering B.V.

FileName : N2-Inlet\_LI4734

Nozzle Calcs.: N1

Noz1: 15 8:26am Jun 21, 2022

$$= \max( 3.318, 4.658 )$$

$$= 4.6577 \text{ mm}$$

Available Nozzle Neck Thickness =  $0.875 * 8.738 = 7.645 \text{ mm}$  --> OK

### Nozzle Junction Minimum Design Metal Temperature (MDMT) Calculations:

#### Nozzle Neck to Flange Weld, Curve: B

Govrn. thk, tg = 7.645, tr = 0.318, c = 3 mm, E\* = 1

Thickness Ratio =  $tr * E*/(tg - c) = 0.0685$ , Temp. Reduction = 78 °C

Min Metal Temp. w/o impact per UCS-66, Curve B -29 °C

Min Metal Temp. at Required thickness (UCS 66.1) -104 °C

#### Nozzle-Shell/Head Weld (UCS-66(a)1(b)), Curve: B

Govrn. thk, tg = 7.645, tr = 0.318, c = 3 mm, E\* = 1

Thickness Ratio =  $tr * E*/(tg - c) = 0.0685$ , Temp. Reduction = 78 °C

Min Metal Temp. w/o impact per UCS-66, Curve B -29 °C

Min Metal Temp. at Required thickness (UCS 66.1) -104 °C

Gov. MDMT of the nozzle to shell joint welded assembly : -104 °C

#### Flange MDMT including Temperature reduction per UCS-66.1:

Unadjusted MDMT of ASME B16.5/47 flanges per UCS-66(c) -18 °C

Flange MDMT with Temp reduction per UCS-66(b)(1)(-b) -38 °C

Where the Stress Reduction Ratio per UCS-66(b)(1)(-b) is :

$$\text{Design Pressure/Ambient Rating} = 1.25/1.96 = 0.638$$

#### Weld Size Calculations, Description: N1

Intermediate Calc. for nozzle/shell Welds Tmin 5.7376 mm

#### Results Per UW-16.1:

	Required Thickness	Actual Thickness
Nozzle Weld	$4.0163 = 0.7 * t_{min}$	$4.2420 = 0.7 * W_o$ mm

Skipping the nozzle attachment weld strength calculations. Per UW-15(b)(2) the nozzles exempted by UG-36(c)(3)(a) (small nozzles) do not require a weld strength check.

#### Maximum Allowable Pressure for this Nozzle at this Location:

Converged Maximum Allowable Pressure in the Operating case: 3.204 MPa

Note: The MAWP of this junction was limited by the parent Shell/Head.

The Drop for this Nozzle is : 3.0153 mm

The Cut Length for this Nozzle is, Drop + Ho + H + T : 68.1253 mm

PV Elite is a trademark of Hexagon AB, 2022, All rights reserved.

# Report – 1-stage Discharge\_LI4734 C220006CLC010

## **PV-Elite Calculation Summary**

Client: Airpack Nederland BV.  
Client location: Zierikzee  
Ref number client: 17811-OO-0702(KP)

### **PPV Engineering**

Author: H.Hoezen  
- Telephone: +31 (0)594 581010  
- E-mail: h.hoezen@ppv-engineering.nl

June 22, 2022  
Order number: P22-115-01  
Document number: 22-11501-C02  
Revision: 1

# Table of Contents

Cover Sheet .....	2
Vessel Design Summary: .....	3
Nozzle Summary: .....	5
Nozzle Schedule: .....	6
Bill of Material: .....	7
Input Echo: .....	8
Internal Pressure Calculations: .....	13
Element and Detail Weights: .....	18
Nozzle Flange MAWP: .....	20
Nozzle Calcs.: N1 .....	21
Nozzle Calcs.: N2 .....	24
Nozzle Calcs.: N3 .....	27

N2 Pulsation damper first stage discharge  
C220006CLC010  
Static Calculation

**DESIGN CALCULATION**

*In Accordance with ASME Section VIII Division 1*

ASME Code Version : 2021

Analysis Performed by : PPV-Engineering B.V.

Job File : ...\\1-stage Discharge\_LI4734.pvdb

Date of Analysis : Jun 21,2022 1:55pm

**PV Elite 24 SP1, March 2022**

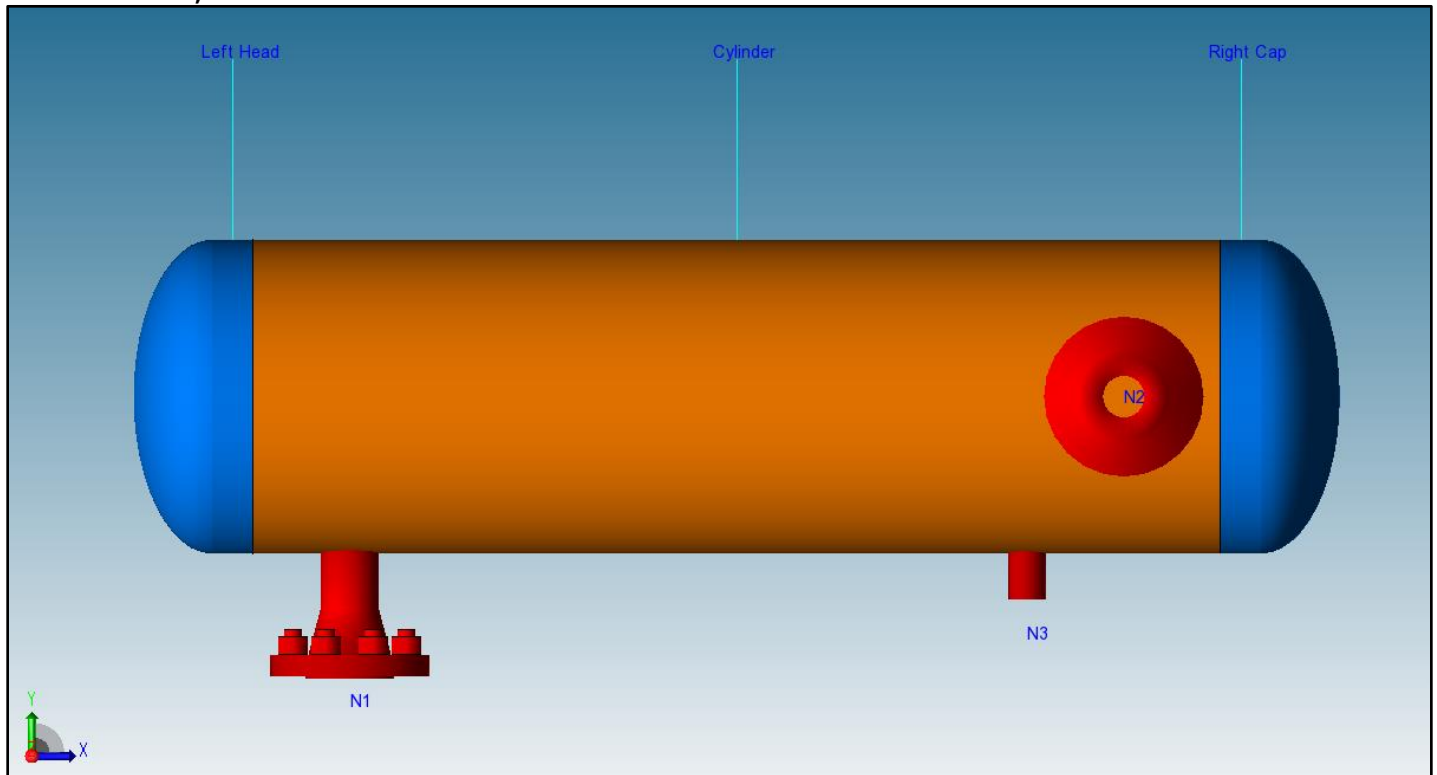

N2 Pulsation damper first stage discharge  
C220006CLC010

Static Calculation

PV Elite 24 SP1 Licensee: PPV-Engineering B.V.

FileName : 1-stage Discharge\_LI4734

Vessel Design Summary: Step: 15 1:55pm Jun 21, 2022

### Vessel Design Summary:

#### ASME Code, Section VIII Division 1, 2021

Diameter Spec : 323.800 mm OD  
Vessel Design Length, Tangent to Tangent 1084.63 mm  
Specified Datum Line Distance 42.31 mm  
Internal Design Temperature 170 °C  
Internal Design Pressure 2.400 MPa  
External Design Temperature 170 °C  
Maximum Allowable Working Pressure 3.35 MPa  
Shop Test Pressure 6.640 MPa  
Required Minimum Design Metal Temperature -28.9 °C  
Warmest Computed Minimum Design Metal Temperature -46.0 °C  
Wind Design Code No Wind Loads  
Earthquake Design Code No Seismic

### Materials of Construction:

Component Type	Material	Class	Thickness	UNS #	Normalized	Impact Tested
Shell	SA-106 B	...	...	K03006	No	No
Head	SA-234 WPB	...	...	K03006	No	No
Nozzle	SA-106 B	...	...	K03006	No	No
Nozzle Flg	SA-105	...	...	K03504	No	No

Normalized is determined based on the UCS-66 material curve selection and Figure UCS-66.  
Impact Tested is based on material selection and material data properties.

### Element Pressures and MAWP (MPa & mm):

Element Description or Type	Design Pressure + Stat. head	Ext. Press.	Element M.A.W.P	Total Corrosion Allowance	Str. Flg. Gov.	In Creep Range
Left Head	2.400	0.00	4.108	3.0000	Yes	No
Cylinder	2.400	0.00	3.350	3.0000	N/A	No
Right Cap	2.400	0.00	4.108	3.0000	Yes	No

### Element Types and Properties:

Element Type	"To" Elev mm	Element Length mm	Nominal Thickness mm	Finished Thickness mm	Reqd Thk Internal mm	Reqd Thk External mm	Long Eff	Circ Eff
Ellipse	0.0	42.3	9.5	9.5	6.7	...	0.85	0.85
Cylinder	1000.0	1000.0	9.5	8.3	6.8	...	0.85	0.85
Ellipse	1042.3	42.3	9.5	9.5	6.7	...	0.85	0.85

N2 Pulsation damper first stage discharge

C220006CLC010

Static Calculation

PV Elite 24 SP1 Licensee: PPV-Engineering B.V.

FileName : 1-stage Discharge\_LI4734

Vessel Design Summary:

-----  
Step: 15 1:55pm Jun 21,2022

**Weights:**

Fabricated - Bare W/O Removable Internals	107.7	kgm
Shop Test - Fabricated + Water ( Full )	195.3	kgm
Shipping - Fab. + Rem. Intls.+ Shipping App.	107.7	kgm
Erected - Fab. + Rem. Intls.+ Insul. (etc)	107.7	kgm
Empty - Fab. + Intls. + Details + Wghts.	107.7	kgm
Operating - Empty + Operating Liquid (No CA)	107.7	kgm
Field Test - Empty Weight + Water (Full)	195.3	kgm

**PV Elite is a trademark of Hexagon AB, 2022, All rights reserved.**

N2 Pulsation damper first stage discharge

C220006CLC010

Static Calculation

PV Elite 24 SP1 Licensee: PPV-Engineering B.V.

FileName : 1-stage Discharge\_LI4734

Nozzle Summary:

Step: 13 1:55pm Jun 21,2022

### Nozzle Calculation Summary (MPa & mm):

Description	MAWP	Ext	MAPNC	UG-45	[tr]	Weld Path	Areas or Stresses
N1	3.35	...	...	OK	6.20	OK	No Calc[*]
N2	3.35	...	...	OK	6.20	OK	No Calc[*]
N3	3.35	...	...	OK	6.12	OK	No Calc[*]

### Nozzle MAWP Summary:

Minimum MAWP Nozzles : 3.35 Nozzle : N3  
 Minimum MAWP Shells/Flanges : 3.35 Element : Cylinder  
 Minimum MAPnc Shells/Flanges : 5.271 Element : Cylinder

Computed Vessel M.A.W.P. : 3.35 MPa

[\*] - This was a small opening and the areas were not computed.

Note: MAWPs (Internal Case) shown above are at the High Point.

*Multiple output lines for the same nozzle indicates required Code calculations in both the longitudinal and circumferential planes of reinforcement where applicable.*

### Check the Spatial Relationship between the Nozzles:

From Node	Nozzle Description	X Coordinate mm	Layout Angle deg	Dia. Limit mm
20	N1	142.315	270.000	97.700
20	N2	942.315	0.000	97.700
20	N3	842.315	270.000	54.672

### The nozzle spacing is computed by the following:

= sqrt( ll<sup>2</sup> + lc<sup>2</sup> ) where

ll - Arc length along the inside vessel surface in the long. direction.

lc - Arc length along the inside vessel surface in the circ. direction

If any interferences/violations are found, they will be noted below.

No interference violations have been detected!

**PV Elite is a trademark of Hexagon AB, 2022, All rights reserved.**

## N2 Pulsation damper first stage discharge

C220006CLC010

## Static Calculation

PV Elite 24 SP1 Licensee: PPV-Engineering B.V.

FileName : 1-stage Discharge\_LI4734

Nozzle Schedule: Step: 12 1:55pm Jun 21, 2022

**Nozzle Schedule:**

Description	Nominal or Actual Size	Schd or FVC Type	Flg Type	Nozzle O/Dia mm	Wall Thk mm	Reinforcing Diameter	Pad Thk mm	Cut Length mm	Flg Class
N3	38 mm	Actual	None	38.1	8.382	...	...	57	...
N1	50 mm	160	WNF	60.3	8.738	...	...	68	300
N2	50 mm	160	WNF	60.3	8.738	...	...	68	300

*General Notes for the above table:*

The Cut Length is the Outside Projection + Inside Projection + Drop + In Plane Shell Thickness. This value does not include weld gaps, nor does it account for shrinkage.

In the case of Oblique Nozzles, the Outside Diameter must be increased. The Re-Pad WIDTH around the nozzle is calculated as follows:  
Width of Pad = (Pad Outside Dia. (per above) - Nozzle Outside Dia.)/2

For hub nozzles, the thickness and diameter shown are those of the smaller and thinner section.

**Nozzle Material and Weld Fillet Leg Size Details (mm):**

Description	Material	Shl Grve Weld	Noz Shl/Pad Weld	Pad OD Weld	Pad Grve Weld	Inside Weld
N3	SA-106 B	8.340	6.000	...	...	...
N1	SA-106 B	8.340	6.000	...	...	...
N2	SA-106 B	8.340	6.000	...	...	...

Note: The Outside projections below do not include the flange thickness.

**Nozzle Miscellaneous Data:**

Description	Elev/Distance From Datum mm	Layout Angle deg	Proj Outside mm	Proj Inside mm	Installed in Component
N3	800.000	270.0	47.62	0.00	Cylinder
N1	100.000	270.0	57.10	0.00	Cylinder
N2	900.000	0.0	57.10	0.00	Cylinder

PV Elite is a trademark of Hexagon AB, 2022, All rights reserved.

N2 Pulsation damper first stage discharge

C220006CLC010

Static Calculation

PV Elite 24 SP1 Licensee: PPV-Engineering B.V.

FileName : 1-stage Discharge\_LI4734 -----

Bill of Material: Step: 11 1:55pm Jun 21,2022

**Bill of Materials:**

QTY	DESCRIPTION	MATERIAL
2	ELLIPTICAL HEAD: 2.0 X 1, 9.5mm THK X 304.7mm ID X 42.3mm	SA-234 WPB
1	CYLINDER: 9.5mm THK X 307.1mm ID X 1000.0mm	SA-106 B
1	NAMEPLATE	...

PV Elite is a trademark of Hexagon AB, 2022, All rights reserved.

N2 Pulsation damper first stage discharge

C220006CLC010

Static Calculation

PV Elite 24 SP1 Licensee: PPV-Engineering B.V.

FileName : 1-stage Discharge\_LI4734

Input Echo:

-----  
Step: 1 1:55pm Jun 21, 2022

### Units used in this Analysis (SI\_ASME):

Name	System Unit	Constant	User Unit
Length	Feet	304.8000	mm
Force	Pounds	4.4480	N
Mass	Pounds	0.4536	kgm
Area	sq. inches	645.1600	mm <sup>2</sup>
Moment	ft. lbs.	1356.3000	N-mm
Stress	lbs./sq.in.	0.0069	MPa
Temperature	Degrees F	0.5556	°C
Pressure	psig	0.0069	MPa
Elast. Modulus	lbs./sq.in.	0.0069	MPa
Pipe Density	lbs./cu.in.	0.0277	kg/cm <sup>3</sup>
Ins. Density	lbs./cu.ft.	0.1602E-04	kg/cm <sup>3</sup>
Fluid Density	lbs./cu.ft.	0.1602E-04	kg/cm <sup>3</sup>
Wind Speed	miles/hr	1.6093	km/hr
Tray Weight	lbs./sq.ft.	0.0005	kg/cm <sup>2</sup>
Inertia	in.**4	416231.0000	mm**4
G Load	G's	1.0000	g's
Wind Load	lbs./sq.ft.	0.0479	kPa
Elevation	Feet	304.8000	mm
Volume	in.**3	0.0164	ltr
Diameter	inches	25.4000	mm
Thickness	inches	25.4000	mm

### PV Elite Vessel Analysis Program: Input Data

N2 Pulsation damper first stage discharge

C220006CLC010

Static Calculation

Design Internal Pressure (for Hydrotest)	2.4	MPa
Design Internal Temperature	170.0	°C
Projection of Nozzle from Vessel Top	0	mm
Projection of Nozzle from Vessel Bottom	0	mm
Minimum Design Metal Temperature	-28.9	°C
Type of Construction	Welded	
Special Service	None	
Degree of Radiography	RT-3	
Use Higher Longitudinal Stresses (Flag)	Y	
Select t for Internal Pressure (Flag)	N	
Select t for External Pressure (Flag)	N	
Select t for Axial Stress (Flag)	N	
Select Location for Stiff. Rings (Flag)	N	
Consider Vortex Shedding	N	

### Shop Pressure Test:

Type of Pressure Test	User Entered Pressure
Pressure Test Position	Horizontal

Load Case 1	NP+EW+WI+FW+BW
Load Case 2	NP+EW+EE+FS+BS
Load Case 3	NP+OW+WI+FW+BW
Load Case 4	NP+OW+EQ+FS+BS
Load Case 5	NP+HW+HI
Load Case 6	NP+HW+HE

## N2 Pulsation damper first stage discharge

C220006CLC010

## Static Calculation

PV Elite 24 SP1 Licensee: PPV-Engineering B.V.

FileName : 1-stage Discharge\_LI4734

Input Echo:

-----  
Step: 1 1:55pm Jun 21, 2022

Load Case 7	IP+OW+WI+FW+BW
Load Case 8	IP+OW+EQ+FS+BS
Load Case 9	EP+OW+WI+FW+BW
Load Case 10	EP+OW+EQ+FS+BS
Load Case 11	HP+HW+HI
Load Case 12	HP+HW+HE
Load Case 13	IP+WE+EW
Load Case 14	IP+WF+CW
Load Case 15	IP+VO+OW
Load Case 16	IP+VE+EW
Load Case 17	NP+VO+OW
Load Case 18	FS+BS+IP+OW
Load Case 19	FS+BS+EP+OW

Wind Design Code No Wind Loads

Seismic Design Code No Seismic

Design Pressure + Static Head	Y
Consider MAP New and Cold in Noz. Design	N
Consider External Loads for Nozzle Des.	Y
Use ASME VIII-1 Appendix 1-9	N

Perform Blast Load Analysis	No
Material Database Year	Current w/Addenda or Code Year

**Configuration Directives:**

Do not use Nozzle MDMT Interpretation VIII-1 01-37	No
Use Table G instead of exact equation for "A"	Yes
Shell Head Joints are Tapered	Yes
Compute "K" in corroded condition	Yes
Use Code Case 2286	No
Use the MAWP to compute the MDMT	Yes
For thickness ratios $\leq 0.35$ , MDMT will be -155F (-104C)	Yes
For PWHT & P1 Materials the MDMT can be $< -55F (-48C)$	No
Using Metric Material Databases, ASME II D	No
Calculate B31.3 type stress for Nozzles with Loads	Yes
Reduce the MDMT due to lower membrane stress	Yes
Consider Longitudinal Stress in MDMT Calculations	Yes

**Complete Listing of Vessel Elements and Details:**

Element From Node	10
Element To Node	20
Element Type	Elliptical
Description	Left Head
Distance "FROM" to "TO"	42.315 mm
Element Outside Diameter	323.8 mm
Element Thickness	9.53 mm
Internal Corrosion Allowance	3 mm
Nominal Thickness	9.53 mm
External Corrosion Allowance	0 mm
Design Internal Pressure	2.4 MPa
Design Temperature Internal Pressure	170 °C
Design External Pressure	0 MPa
Design Temperature External Pressure	170 °C
Effective Diameter Multiplier	1.2

N2 Pulsation damper first stage discharge

C220006CLC010

Static Calculation

PV Elite 24 SP1 Licensee: PPV-Engineering B.V.

FileName : 1-stage Discharge\_LI4734

Input Echo: Step: 1 1:55pm Jun 21,2022

Material Name	SA-234 WPB	
Allowable Stress, Ambient	117.9	MPa
Allowable Stress, Operating	117.9	MPa
Allowable Stress, Hydrotest	153.31	MPa
Material Density	0.00775	kg/cm <sup>3</sup>
P Number Thickness	30.988	mm
Yield Stress, Operating	210.91	MPa
UCS-66 Chart Curve Designation	B	
External Pressure Chart Name	CS-2	
UNS Number	K03006	
Product Form	Smls. & wld. fittings	
Efficiency, Longitudinal Seam	0.85	
Efficiency, Circumferential Seam	0.85	
Elliptical Head Factor	2.0	
Weld is pre-Heated	No	

Element From Node	20	
Element To Node	30	
Element Type	Cylinder	
Description	Cylinder	
Distance "FROM" to "TO"	1000	mm
Element Outside Diameter	323.8	mm
Element Thickness	8.34	mm
Internal Corrosion Allowance	3	mm
Nominal Thickness	9.53	mm
External Corrosion Allowance	0	mm
Design Internal Pressure	2.4	MPa
Design Temperature Internal Pressure	170	°C
Design External Pressure	0	MPa
Design Temperature External Pressure	170	°C
Effective Diameter Multiplier	1.2	
Material Name	SA-106 B	
Allowable Stress, Ambient	117.9	MPa
Allowable Stress, Operating	117.9	MPa
Allowable Stress, Hydrotest	153.31	MPa
Material Density	0.00775	kg/cm <sup>3</sup>
P Number Thickness	30.988	mm
Yield Stress, Operating	210.91	MPa
UCS-66 Chart Curve Designation	B	
External Pressure Chart Name	CS-2	
UNS Number	K03006	
Product Form	Smls. pipe	
Efficiency, Longitudinal Seam	0.85	
Efficiency, Circumferential Seam	0.85	
Weld is pre-Heated	No	

Element From Node	20	
Detail Type	Nozzle	
Detail ID	N1	
Dist. from "FROM" Node / Offset dist	100	mm
Nozzle Diameter	50	mm
Nozzle Schedule	160	
Nozzle Class	300	
Layout Angle	270.0	
Blind Flange (Y/N)	N	
Weight of Nozzle ( Used if > 0 )	0	N
Grade of Attached Flange	GR 1.1	

N2 Pulsation damper first stage discharge

C220006CLC010

Static Calculation

PV Elite 24 SP1 Licensee: PPV-Engineering B.V.

FileName : 1-stage Discharge\_LI4734

Input Echo:

-----  
Step: 1 1:55pm Jun 21,2022

Nozzle Matl	SA-106 B
Element From Node	20
Detail Type	Nozzle
Detail ID	N2
Dist. from "FROM" Node / Offset dist	900 mm
Nozzle Diameter	50 mm
Nozzle Schedule	160
Nozzle Class	300
Layout Angle	0.0
Blind Flange (Y/N)	N
Weight of Nozzle ( Used if > 0 )	0 N
Grade of Attached Flange	GR 1.1
Nozzle Matl	SA-106 B
Element From Node	20
Detail Type	Nozzle
Detail ID	N3
Dist. from "FROM" Node / Offset dist	800 mm
Nozzle Diameter	38.1 mm
Nozzle Schedule	None
Nozzle Class	None
Layout Angle	270.0
Blind Flange (Y/N)	N
Weight of Nozzle ( Used if > 0 )	0 N
Grade of Attached Flange	None
Nozzle Matl	SA-106 B

-----

N2 Pulsation damper first stage discharge

C220006CLC010

Static Calculation

PV Elite 24 SP1 Licensee: PPV-Engineering B.V.

FileName : 1-stage Discharge\_LI4734

Input Echo: Step: 1 1:55pm Jun 21,2022

Element From Node	30	
Element To Node	40	
Element Type	Elliptical	
Description	Right Cap	
Distance "FROM" to "TO"	42.315	mm
Element Outside Diameter	323.8	mm
Element Thickness	9.53	mm
Internal Corrosion Allowance	3	mm
Nominal Thickness	9.53	mm
External Corrosion Allowance	0	mm
Design Internal Pressure	2.4	MPa
Design Temperature Internal Pressure	170	°C
Design External Pressure	0	MPa
Design Temperature External Pressure	170	°C
Effective Diameter Multiplier	1.2	
Material Name	SA-234 WPB	
Allowable Stress, Ambient	117.9	MPa
Allowable Stress, Operating	117.9	MPa
Allowable Stress, Hydrotest	153.31	MPa
Material Density	0.00775	kg/cm <sup>3</sup>
P Number Thickness	30.988	mm
Yield Stress, Operating	210.91	MPa
UCS-66 Chart Curve Designation	B	
External Pressure Chart Name	CS-2	
UNS Number	K03006	
Product Form	Smls. & wld. fittings	
Efficiency, Longitudinal Seam	0.85	
Efficiency, Circumferential Seam	0.85	
Elliptical Head Factor	2.0	
Weld is pre-Heated	No	

PV Elite is a trademark of Hexagon AB, 2022, All rights reserved.

N2 Pulsation damper first stage discharge  
C220006CLC010

Static Calculation

PV Elite 24 SP1 Licensee: PPV-Engineering B.V.

FileName : 1-stage Discharge\_LI4734

Internal Pressure Calculations: Step: 3 1:55pm Jun 21, 2022

### Internal Pressure Results Summary:

#### Element Thickness, Pressure, Diameter and Allowable Stress :

From	To	Int. Press + Liq. Hd MPa	Nominal Thickness mm	Total Corr Allowance mm	Element Diameter mm	Allowable Stress(SE) MPa
Left Head		2.4	9.53	3	323.8	100.22
Cylinder		2.4	9.53	3	323.8	100.22
Right Cap		2.4	9.53	3	323.8	100.22

#### Element Required Thickness and MAWP :

From	To	Design Pressure MPa	M.A.W.P. Corroded MPa	M.A.P. New & Cold MPa	Minimum Thickness mm	Required Thickness mm
Left Head		2.4	4.108	6.229	9.53	6.70255
Cylinder		2.4	3.35	5.271	8.34	6.84034
Right Cap		2.4	4.108	6.229	9.53	6.70255
Minimum			3.35	5.11		

Note : The M.A.P.(NC) is Governed by a Flange !

MAWP: 3.35 MPa, limited by: Cylinder.

Elements Suitable for Design Internal Pressure.

### Internal Pressure Calculation Results:

#### ASME Code, Section VIII Division 1, 2021

#### Elliptical Head From 10 To 20 SA-234 WPB , UCS-66 Crv. B at 170 °C

Left Head

Longitudinal Joint: User Defined

Material UNS Number: K03006

Required Thickness due to Internal Pressure [tr]:

$$\begin{aligned}
 &= (P \cdot D_o \cdot K_{cor}) / (2 \cdot S \cdot E + 2 \cdot P \cdot (K_{cor} - 0.1)) \text{ per Appendix 1-4 (c)} \\
 &= (2.4 \cdot 323.8 \cdot 0.975) / (2 \cdot 117.9 \cdot 0.85 + 2 \cdot 2.4 \cdot (0.975 - 0.1)) \\
 &= 3.7025 + 3.0000 = 6.7025 \text{ mm}
 \end{aligned}$$

Max. Allowable Working Pressure at given Thickness, corroded [MAWP]:

$$\begin{aligned}
 &= (2 \cdot S \cdot E \cdot t) / (K_{cor} \cdot D_o - 2 \cdot t \cdot (K_{cor} - 0.1)) \text{ per Appendix 1-4 (c)} \\
 &= (2 \cdot 117.9 \cdot 0.85 \cdot 6.53) / (0.975 \cdot 323.8 - 2 \cdot 6.53 \cdot (0.975 - 0.1)) \\
 &= 4.302 \text{ MPa}
 \end{aligned}$$

Maximum Allowable Pressure, New and Cold [MAPNC]:

$$\begin{aligned}
 &= (2 \cdot S \cdot E \cdot t) / (K \cdot D_o - 2 \cdot t \cdot (K - 0.1)) \text{ per Appendix 1-4 (c)} \\
 &= (2 \cdot 117.9 \cdot 0.85 \cdot 9.53) / (1 \cdot 323.8 - 2 \cdot 9.53 \cdot (1 - 0.1)) \\
 &= 6.229 \text{ MPa}
 \end{aligned}$$

N2 Pulsation damper first stage discharge  
C220006CLC010

**Static Calculation**

PV Elite 24 SP1 Licensee: PPV-Engineering B.V.

FileName : 1-stage Discharge\_LI4734 -----

Internal Pressure Calculations: Step: 3 1:55pm Jun 21, 2022

Actual stress at given pressure and thickness, corroded [Sact]:

$$= (P*(Kcor*Do-2*t*(Kcor-0.1)))/(2*E*t)$$

$$= (2.4*(0.975*323.8-2*6.53*(0.975-0.1)))/(2*0.85*6.53)$$

$$= 65.783 \text{ MPa}$$

Straight Flange Required Thickness:

$$= (P*Ro)/(S*E+0.4*P) + ca \text{ per Appendix 1-1 (a)(1)}$$

$$= (2.4*161.9)/(117.9*0.85+0.4*2.4)+3$$

$$= 6.840 \text{ mm}$$

Straight Flange Maximum Allowable Working Pressure:

$$= (S*E*t)/(Ro-0.4*t) \text{ per Appendix 1-1 (a)(1)}$$

$$= (117.9 * 0.85 * 6.53 )/(161.9 - 0.4 * 6.53 )$$

$$= 4.108 \text{ MPa}$$

Factor K, corroded condition [Kcor]:

$$= ( 2 + ( \text{Inside Diameter}/( 2 * \text{Inside Head Depth} ) )^2)/6$$

$$= ( 2 + ( 310.7/( 2 * 79.18 ) )^2)/6$$

$$= 0.974982$$

**MDMT Calculations in the Knuckle Portion:**

Govrn. thk, tg = 9.53, tr = 5.126, c = 3 mm, E\* = 0.85

Thickness Ratio = tr \* E\*/(tg - c) = 0.667, Temp. Reduction = 18 °C

Min Metal Temp. w/o impact per UCS-66, Curve B -29 °C  
Min Metal Temp. at Required thickness (UCS 66.1) -47 °C

**MDMT Calculations in the Head Straight Flange:**

Govrn. thk, tg = 9.53, tr = 5.34, c = 3 mm, E\* = 0.85

Thickness Ratio = tr \* E\*/(tg - c) = 0.695, Temp. Reduction = 17 °C

Min Metal Temp. w/o impact per UCS-66, Curve B -29 °C  
Min Metal Temp. at Required thickness (UCS 66.1) -46 °C

**Cylindrical Shell From 20 To 30 SA-106 B , UCS-66 Crv. B at 170 °C**

Cylinder

Longitudinal Joint: Spot Radiography per UW-11(b) Type 1

Material UNS Number: K03006

Required Thickness due to Internal Pressure [tr]:

$$= (P*Ro) / (S*E+0.4*P) \text{ per Appendix 1-1 (a)(1)}$$

$$= (2.4*161.9)/(117.9*0.85+0.4*2.4)$$

$$= 3.8403 + 3.0000 = 6.8403 \text{ mm}$$

Max. Allowable Working Pressure at given Thickness, corroded [MAWP]:

$$= (S*E*t)/(Ro-0.4*t) \text{ per Appendix 1-1 (a)(1)}$$

$$= (117.9*0.85*5.34)/(161.9-0.4*5.34)$$

$$= 3.35 \text{ MPa}$$

Maximum Allowable Pressure, New and Cold [MAPNC]:

$$= (S*E*t)/(Ro-0.4*t) \text{ per Appendix 1-1 (a)(1)}$$

$$= (117.9*0.85*8.34)/(161.9-0.4*8.34)$$

$$= 5.271 \text{ MPa}$$

N2 Pulsation damper first stage discharge  
C220006CLC010

Static Calculation

PV Elite 24 SP1 Licensee: PPV-Engineering B.V.

FileName : 1-stage Discharge\_LI4734

Internal Pressure Calculations: Step: 3 1:55pm Jun 21, 2022

Actual stress at given pressure and thickness, corroded [Sact]:

$$= (P*(Ro-0.4*t))/(E*t)$$

$$= (2.4*((161.9-0.4*5.34))/(0.85*5.34))$$

$$= 84.475 \text{ MPa}$$

**Minimum Design Metal Temperature Results:**

Govrn. thk, tg = 8.34, tr = 2.599, c = 3 mm, E\* = 0.85

Thickness Ratio = tr \* E\*/(tg - c) = 0.414, Temp. Reduction = 47 °C

Min Metal Temp. w/o impact per UCS-66, Curve B -29 °C

Min Metal Temp. at Required thickness (UCS 66.1) -48 °C

**Elliptical Head From 30 To 40 SA-234 WPB, UCS-66 Crv. B at 170 °C**

Right Cap

Longitudinal Joint: User Defined

Material UNS Number: K03006

Required Thickness due to Internal Pressure [tr]:

$$= (P*Do*Kcor)/(2*S*E+2*P*(Kcor-0.1)) \text{ per Appendix 1-4 (c)}$$

$$= (2.4*323.8*0.975)/(2*117.9*0.85+2*2.4*(0.975-0.1))$$

$$= 3.7025 + 3.0000 = 6.7025 \text{ mm}$$

Max. Allowable Working Pressure at given Thickness, corroded [MAWP]:

$$= (2*S*E*t)/(Kcor*Do-2*t*(Kcor-0.1)) \text{ per Appendix 1-4 (c)}$$

$$= (2*117.9*0.85*6.53)/(0.975*323.8-2*6.53*(0.975-0.1))$$

$$= 4.302 \text{ MPa}$$

Maximum Allowable Pressure, New and Cold [MAPNC]:

$$= (2*S*E*t)/(K*Do-2*t*(K-0.1)) \text{ per Appendix 1-4 (c)}$$

$$= (2*117.9*0.85*9.53)/(1*323.8-2*9.53*(1-0.1))$$

$$= 6.229 \text{ MPa}$$

Actual stress at given pressure and thickness, corroded [Sact]:

$$= (P*(Kcor*Do-2*t*(Kcor-0.1)))/(2*E*t)$$

$$= (2.4*(0.975*323.8-2*6.53*(0.975-0.1)))/(2*0.85*6.53)$$

$$= 65.783 \text{ MPa}$$

Straight Flange Required Thickness:

$$= (P*Ro)/(S*E+0.4*P) + ca \text{ per Appendix 1-1 (a)(1)}$$

$$= (2.4*161.9)/(117.9*0.85+0.4*2.4)+3$$

$$= 6.840 \text{ mm}$$

Straight Flange Maximum Allowable Working Pressure:

$$= (S*E*t)/(Ro-0.4*t) \text{ per Appendix 1-1 (a)(1)}$$

$$= (117.9 * 0.85 * 6.53)/(161.9 - 0.4 * 6.53)$$

$$= 4.108 \text{ MPa}$$

Factor K, corroded condition [Kcor]:

$$= (2 + (\text{Inside Diameter}/(2 * \text{Inside Head Depth}))^2)/6$$

$$= (2 + (310.7/(2 * 79.18))^2)/6$$

$$= 0.974982$$

**MDMT Calculations in the Knuckle Portion:**

Govrn. thk, tg = 9.53, tr = 5.126, c = 3 mm, E\* = 0.85

N2 Pulsation damper first stage discharge  
C220006CLC010

Static Calculation

PV Elite 24 SP1 Licensee: PPV-Engineering B.V.

FileName : 1-stage Discharge\_LI4734

Internal Pressure Calculations: Step: 3 1:55pm Jun 21, 2022

Thickness Ratio =  $tr * E^*/(tg - c) = 0.667$ , Temp. Reduction = 18 °C

Min Metal Temp. w/o impact per UCS-66, Curve B -29 °C  
Min Metal Temp. at Required thickness (UCS 66.1) -47 °C

MDMT Calculations in the Head Straight Flange:

Govrn. thk, tg = 9.53, tr = 5.34, c = 3 mm,  $E^* = 0.85$   
Thickness Ratio =  $tr * E^*/(tg - c) = 0.695$ , Temp. Reduction = 17 °C

Min Metal Temp. w/o impact per UCS-66, Curve B -29 °C  
Min Metal Temp. at Required thickness (UCS 66.1) -46 °C

Note: Heads and Shells Exempted to -20F (-29C) by paragraph UG-20F

Hydrostatic Test Pressure Results:

Pressure per UG99b =  $1.30 * M.A.W.P. * Sa/S$  4.355 MPa  
Pressure per UG99b[35] =  $1.30 * Design Pres * Sa/S$  3.120 MPa  
Pressure per UG99c =  $1.30 * M.A.P. - Head(Hyd)$  6.643 MPa  
Pressure per UG100 =  $1.10 * M.A.W.P. * Sa/S$  3.685 MPa  
Pressure per PED =  $\max(1.43*DP, 1.25*DP*ratio)$  3.432 MPa  
Pressure per App 27-4 = M.A.W.P. 3.350 MPa  
  
User Defined Hydrostatic Test Pressure at High Point 6.640 MPa

Horizontal Test performed per: User Hydro Pressure

Please note that Nozzle, Shell, Head, Flange, etc MAWPs are all considered when determining the hydrotest pressure for those test types that are based on the MAWP of the vessel.

Stresses on Elements due to Test Pressure (MPa):

From To	Stress	Allowable	Ratio	Pressure
Left Head	125.7	153.3	0.820	6.64
Cylinder	148.6	153.3	0.969	6.64
Right Cap	125.7	153.3	0.820	6.64

Stress ratios for Nozzle and Pad Materials (MPa):

Description	Pad/Nozzle	Ambient	Operating	Ratio
N1	Nozzle	117.90	117.90	1.000
N2	Nozzle	117.90	117.90	1.000
N3	Nozzle	117.90	117.90	1.000
Minimum				1.000

Stress ratios for Pressurized Vessel Elements (MPa):

Description	Ambient	Operating	Ratio
Left Head	117.90	117.90	1.000
Cylinder	117.90	117.90	1.000
Right Cap	117.90	117.90	1.000

N2 Pulsation damper first stage discharge

C220006CLC010

Static Calculation

PV Elite 24 SP1 Licensee: PPV-Engineering B.V.

FileName : 1-stage Discharge\_LI4734 -----

Internal Pressure Calculations: Step: 3 1:55pm Jun 21,2022

-----  
Minimum 1.000

**Hoop Stress in Nozzle Wall during Pressure Test (MPa):**

Description	Ambient	Operating	Ratio
N1	20.28	153.28	0.132
N2	20.28	153.28	0.132
N3	12.44	153.28	0.081

-----

Elements Suitable for Test Pressure.

**PV Elite is a trademark of Hexagon AB, 2022, All rights reserved.**

N2 Pulsation damper first stage discharge  
C220006CLC010

Static Calculation

PV Elite 24 SP1 Licensee: PPV-Engineering B.V.

FileName : 1-stage Discharge\_LI4734

Element and Detail Weights: Step: 5 1:55pm Jun 21, 2022

**Element and Detail Weights:**

From	To	Element Metal Wgt. kgm	Element ID Volume ltr	Corroded Metal Wgt. kgm	Corroded ID Volume ltr	Extra due Misc %
10	20	11.8169	6.79203	8.09701	7.13797	...
20	30	73.4771	74.0942	50.8239	77.0175	...
30	40	11.8169	6.79203	8.09701	7.13797	...
Total		97	87.68	67	91.29	0

**Weight of Details:**

From	Type	Weight of Detail kgm	X Offset, Dtl. Cent. mm	Y Offset, Dtl. Cent. mm	Z Offset, Dtl. Cent. mm	Description
20	Noz1	5.12569	100	-183.723	...	N1
20	Noz1	5.12569	900	...	183.723	N2
20	Noz1	0.28886	800	-172.61	...	N3

**Total Weight of Each Detail Type:**

Nozzles	10.5
-----	
Sum of the Detail Weights	10.5 kgm

**Weight Summation Results: (kgm)**

	Fabricated	Shop Test	Shipping	Erected	Empty	Operating
Main Elements	97.1	97.1	97.1	97.1	97.1	97.1
Nozzles	10.5	10.5	10.5	10.5	10.5	10.5
Test Liquid	...	87.6	...	...	...	...
Totals	107.7	195.3	107.7	107.7	107.7	107.7

**Weight Summary:**

Fabricated Wt.	- Bare Weight without Removable Internals	107.7 kgm
Shop Test Wt.	- Fabricated Weight + Water ( Full )	195.3 kgm
Shipping Wt.	- Fab. Weight + removable Intls.+ Shipping App.	107.7 kgm
Erected Wt.	- Fab. Wt + or - loose items (trays,platforms etc.)	107.7 kgm
Ope. Wt. no Liq	- Fab. Weight + Internals. + Details + Weights	107.7 kgm
Operating Wt.	- Empty Weight + Operating Liq. Uncorroded	107.7 kgm
Oper. Wt. + CA	- Corr Wt. + Operating Liquid	77.6 kgm
Field Test Wt.	- Empty Weight + Water (Full)	195.3 kgm

Note:

The Corroded Weight and thickness are used in the Horizontal Vessel Analysis (Ope Case) and Earthquake Load Calculations.

**Outside Surface Areas of Elements:**

From	To	Surface Area
------	----	--------------

N2 Pulsation damper first stage discharge

C220006CLC010

Static Calculation

PV Elite 24 SP1 Licensee: PPV-Engineering B.V.

FileName : 1-stage Discharge\_LI4734 -----

Element and Detail Weights: Step: 5 1:55pm Jun 21,2022

		mm <sup>2</sup>
10	20	156697
20	30	1024724
30	40	156697
Total		1338118.375 mm <sup>2</sup>

PV Elite is a trademark of Hexagon AB, 2022, All rights reserved.

N2 Pulsation damper first stage discharge

C220006CLC010

Static Calculation

PV Elite 24 SP1 Licensee: PPV-Engineering B.V.

FileName : 1-stage Discharge\_LI4734

Nozzle Flange MAWP: Step: 6 1:55pm Jun 21,2022

**Nozzle Flange MAWP Results: (MPa & °C)**

Nozzle Description	Flange Rating		Design Temp	Class	Grade/Group	Equiv. Press	Max Pressure		
	Op.	Ambient					UG-44(b)	50%	DNV
N1	4.46	5.11	170	300	GR 1.1	...	...	...	...
N2	4.46	5.11	170	300	GR 1.1	...	...	...	...
Min Rating	4.458	5.110 MPa [for Core Elements]					...	...	...

Pressure Ratings are per ASME B16.5 2017 Metric Edition

PV Elite is a trademark of Hexagon AB, 2022, All rights reserved.

N2 Pulsation damper first stage discharge  
C220006CLC010

Static Calculation

PV Elite 24 SP1 Licensee: PPV-Engineering B.V.

FileName : 1-stage Discharge\_LI4734

Nozzle Calcs.: N1 Nozl: 13 1:55pm Jun 21,2022

**Input, Nozzle Desc: N1**

**From: 20**

Pressure for Reinforcement Calculations	P	2.4000	MPa
Temperature for Internal Pressure	Temp	170	°C
Parent Material		SA-106 B	
Parent Allowable Stress at Temperature	Sv	117.90	MPa
Parent Allowable Stress At Ambient	Sva	117.90	MPa
Inside Diameter of Cylindrical Shell	D	304.74	mm
Shell Finished (Minimum) Thickness	t	8.3400	mm
Shell Internal Corrosion Allowance	c	3.0000	mm
Shell External Corrosion Allowance	co	0.0000	mm
Distance from Bottom/Left Tangent		142.32	mm
User Entered Minimum Design Metal Temperature		-28.89	°C

**Type of Element Connected to the Parent : Nozzle**

Material		SA-106 B	
Material UNS Number		K03006	
Material Specification/Type		Smls. pipe	
Allowable Stress at Temperature	Sn	117.90	MPa
Allowable Stress At Ambient	Sna	117.90	MPa
Diameter Basis (for tr calc only)		Outside	
Layout Angle		270.00	deg
Diameter		50.0000	mm
Size and Thickness Basis		Nominal	
Nominal Thickness		160	
Flange Material		SA-105	
Flange Type		Weld Neck Flange	
Corrosion Allowance	can	3.0000	mm
Joint Efficiency of Shell Seam at Nozzle	E1	1.00	
Joint Efficiency of Nozzle Neck	En	1.00	
Outside Projection	ho	57.1000	mm
Weld leg size between Nozzle and Pad/Shell	Wo	6.0000	mm
Groove weld depth between Nozzle and Vessel Wgnv		8.3400	mm
Flange Class		300	
Flange Grade		GR 1.1	

The Pressure Design option was Design Pressure + static head.

**Nozzle Sketch (may not represent actual weld type/configuration)**

N2 Pulsation damper first stage discharge

C220006CLC010

Static Calculation

PV Elite 24 SP1 Licensee: PPV-Engineering B.V.

FileName : 1-stage Discharge\_LI4734

Nozzle Calcs.: N1

Nozl: 13 1:55pm Jun 21,2022

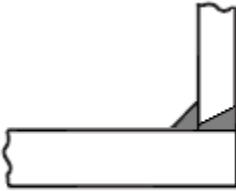

### Abutting/Set-on Nozzle No Pad

### Reinforcement CALCULATION, Description: N1

ASME Code, Section VIII, Div. 1, 2021, UG-37 to UG-45

Actual Outside Diameter Used in Calculation	60.325 mm.
Actual Thickness Used in Calculation	8.738 mm

Nozzle input data check completed without errors.

Reqd thk per UG-37(a) of Cylindrical Shell, tr [Int. Press]

$$= P \cdot R / (S_v \cdot E - 0.6 \cdot P) \text{ per UG-27 (c)(1)}$$

$$= 2.4 \cdot 155.4 / (117.9 \cdot 1 - 0.6 \cdot 2.4)$$

$$= 3.2017 \text{ mm}$$

Reqd thk per UG-37(a) of Nozzle Wall, trn [Int. Press]

$$= P \cdot R_o / (S_n \cdot E + 0.4 \cdot P) \text{ per Appendix 1-1 (a)(1)}$$

$$= 2.4 \cdot 30.16 / (117.9 \cdot 1 + 0.4 \cdot 2.4)$$

$$= 0.6090 \text{ mm}$$

### UG-40, Limits of Reinforcement : [Internal Pressure]

Parallel to Vessel Wall (Diameter Limit)	D1	97.6996 mm
Parallel to Vessel Wall, opening length	d	48.8498 mm
Normal to Vessel Wall (Thickness Limit), no pad	Tlnp	13.3500 mm

*Taking a UG-36(c)(3)(a) exemption for nozzle: N1.*

*This calculation is valid for nozzles that meet all the requirements of paragraph UG-36. Please check the Code carefully, especially for nozzles that are not isolated or do not meet Code spacing requirements. To force the computation of areas for small nozzles go to Tools->Configuration and check the box to force the UG-37 small nozzle area calculation.*

### UG-45 Minimum Nozzle Neck Thickness Requirement: [Int. Press.]

Wall Thickness for Internal/External pressures	ta = 3.6090 mm
Wall Thickness per UG16(b),	tr16b = 4.5000 mm
Wall Thickness, shell/head, internal pressure	trb1 = 6.2017 mm
Wall Thickness	tb1 = max(trb1, tr16b) = 6.2017 mm
Wall Thickness	tb2 = max(trb2, tr16b) = 4.5000 mm
Wall Thickness per table UG-45	tb3 = 6.4200 mm

Determine Nozzle Thickness candidate [tb]:

$$= \min[ tb3, \max( tb1, tb2 ) ]$$

$$= \min[ 6.42, \max( 6.202, 4.5 ) ]$$

$$= 6.2017 \text{ mm}$$

Minimum Wall Thickness of Nozzle Necks [tUG-45]:

$$= \max( ta, tb )$$

**N2 Pulsation damper first stage discharge**

C220006CLC010

**Static Calculation**

PV Elite 24 SP1 Licensee: PPV-Engineering B.V.

FileName : 1-stage Discharge\_LI4734 -----

Nozzle Calcs.: N1 Nozl: 13 1:55pm Jun 21, 2022

$$= \max( 3.609, 6.202 )$$

$$= 6.2017 \text{ mm}$$

Available Nozzle Neck Thickness =  $0.875 * 8.738 = 7.645 \text{ mm}$  --> OK**Nozzle Junction Minimum Design Metal Temperature (MDMT) Calculations:****Nozzle Neck to Flange Weld, min( Curve:B, Curve:A)**

Govrn. thk, tg = 7.645, tr = 0.609, c = 3 mm, E\* = 1

Thickness Ratio =  $tr * E*/(tg - c) = 0.131$ , Temp. Reduction = 78 °C

Min Metal Temp. w/o impact per UCS-66, Curve A -8 °C

Min Metal Temp. at Required thickness (UCS 66.1) -104 °C

Min Metal Temp. w/o impact per UG-20(f) -29 °C

**Nozzle-Shell/Head Weld (UCS-66(a)1(b)), Curve: B**

Govrn. thk, tg = 7.645, tr = 0.609, c = 3 mm, E\* = 1

Thickness Ratio =  $tr * E*/(tg - c) = 0.131$ , Temp. Reduction = 78 °C

Min Metal Temp. w/o impact per UCS-66, Curve B -29 °C

Min Metal Temp. at Required thickness (UCS 66.1) -104 °C

Gov. MDMT of the nozzle to shell joint welded assembly : -104 °C

**Flange MDMT including Temperature reduction per UCS-66.1:**

Unadjusted MDMT of ASME B16.5/47 flanges per UCS-66(c) -18 °C

Flange MDMT with Temp reduction per UCS-66(b)(1)(-b) -48 °C

Where the Stress Reduction Ratio per UCS-66(b)(1)(-b) is :

$$\text{Design Pressure/Ambient Rating} = 2.40/5.11 = 0.470$$

**Weld Size Calculations, Description: N1**

Intermediate Calc. for nozzle/shell Welds Tmin 5.7376 mm

**Results Per UW-16.1:**

	Required Thickness	Actual Thickness
Nozzle Weld	$4.0163 = 0.7 * t_{min}$	$4.2420 = 0.7 * W_o$ mm

Skipping the nozzle attachment weld strength calculations. Per UW-15(b)(2) the nozzles exempted by UG-36(c)(3)(a) (small nozzles) do not require a weld strength check.

**Maximum Allowable Pressure for this Nozzle at this Location:**

Converged Maximum Allowable Pressure in the Operating case: 3.35 MPa

Note: The MAWP of this junction was limited by the parent Shell/Head.

The Drop for this Nozzle is : 3.0152 mm

The Cut Length for this Nozzle is, Drop + Ho + H + T : 68.4552 mm

**PV Elite is a trademark of Hexagon AB, 2022, All rights reserved.**

N2 Pulsation damper first stage discharge  
 C220006CLC010

Static Calculation

PV Elite 24 SP1 Licensee: PPV-Engineering B.V.

FileName : 1-stage Discharge\_LI4734

Nozzle Calcs.: N2 Nozl: 14 1:55pm Jun 21,2022

**Input, Nozzle Desc: N2**

**From: 20**

Pressure for Reinforcement Calculations	P	2.4000	MPa
Temperature for Internal Pressure	Temp	170	°C
Parent Material		SA-106 B	
Parent Allowable Stress at Temperature	Sv	117.90	MPa
Parent Allowable Stress At Ambient	Sva	117.90	MPa
Inside Diameter of Cylindrical Shell	D	304.74	mm
Shell Finished (Minimum) Thickness	t	8.3400	mm
Shell Internal Corrosion Allowance	c	3.0000	mm
Shell External Corrosion Allowance	co	0.0000	mm
Distance from Bottom/Left Tangent		942.32	mm
User Entered Minimum Design Metal Temperature		-28.89	°C

**Type of Element Connected to the Parent : Nozzle**

Material		SA-106 B	
Material UNS Number		K03006	
Material Specification/Type		Smls. pipe	
Allowable Stress at Temperature	Sn	117.90	MPa
Allowable Stress At Ambient	Sna	117.90	MPa
Diameter Basis (for tr calc only)		Outside	
Layout Angle		0.00	deg
Diameter		50.0000	mm
Size and Thickness Basis		Nominal	
Nominal Thickness		160	
Flange Material		SA-105	
Flange Type		Weld Neck Flange	
Corrosion Allowance	can	3.0000	mm
Joint Efficiency of Shell Seam at Nozzle	E1	1.00	
Joint Efficiency of Nozzle Neck	En	1.00	
Outside Projection	ho	57.1000	mm
Weld leg size between Nozzle and Pad/Shell	Wo	6.0000	mm
Groove weld depth between Nozzle and Vessel Wgnv		8.3400	mm
Flange Class		300	
Flange Grade		GR 1.1	

The Pressure Design option was Design Pressure + static head.

**Nozzle Sketch (may not represent actual weld type/configuration)**

N2 Pulsation damper first stage discharge

C220006CLC010

Static Calculation

PV Elite 24 SP1 Licensee: PPV-Engineering B.V.

FileName : 1-stage Discharge\_LI4734

Nozzle Calcs.: N2

Nozl: 14 1:55pm Jun 21,2022

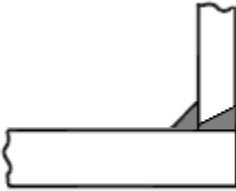

### Abutting/Set-on Nozzle No Pad

### Reinforcement CALCULATION, Description: N2

ASME Code, Section VIII, Div. 1, 2021, UG-37 to UG-45

Actual Outside Diameter Used in Calculation	60.325 mm.
Actual Thickness Used in Calculation	8.738 mm

Nozzle input data check completed without errors.

Reqd thk per UG-37(a) of Cylindrical Shell, tr [Int. Press]

$$= P \cdot R / (S_v \cdot E - 0.6 \cdot P) \text{ per UG-27 (c)(1)}$$

$$= 2.4 \cdot 155.4 / (117.9 \cdot 1 - 0.6 \cdot 2.4)$$

$$= 3.2017 \text{ mm}$$

Reqd thk per UG-37(a) of Nozzle Wall, trn [Int. Press]

$$= P \cdot R_o / (S_n \cdot E + 0.4 \cdot P) \text{ per Appendix 1-1 (a)(1)}$$

$$= 2.4 \cdot 30.16 / (117.9 \cdot 1 + 0.4 \cdot 2.4)$$

$$= 0.6090 \text{ mm}$$

### UG-40, Limits of Reinforcement : [Internal Pressure]

Parallel to Vessel Wall (Diameter Limit)	D1	97.6996 mm
Parallel to Vessel Wall, opening length	d	48.8498 mm
Normal to Vessel Wall (Thickness Limit), no pad	Tlnp	13.3500 mm

*Taking a UG-36(c)(3)(a) exemption for nozzle: N2.*

*This calculation is valid for nozzles that meet all the requirements of paragraph UG-36. Please check the Code carefully, especially for nozzles that are not isolated or do not meet Code spacing requirements. To force the computation of areas for small nozzles go to Tools->Configuration and check the box to force the UG-37 small nozzle area calculation.*

### UG-45 Minimum Nozzle Neck Thickness Requirement: [Int. Press.]

Wall Thickness for Internal/External pressures	ta = 3.6090 mm
Wall Thickness per UG16(b),	tr16b = 4.5000 mm
Wall Thickness, shell/head, internal pressure	trb1 = 6.2017 mm
Wall Thickness	tb1 = max(trb1, tr16b) = 6.2017 mm
Wall Thickness	tb2 = max(trb2, tr16b) = 4.5000 mm
Wall Thickness per table UG-45	tb3 = 6.4200 mm

Determine Nozzle Thickness candidate [tb]:

$$= \min[ tb3, \max( tb1, tb2 ) ]$$

$$= \min[ 6.42, \max( 6.202, 4.5 ) ]$$

$$= 6.2017 \text{ mm}$$

Minimum Wall Thickness of Nozzle Necks [tUG-45]:

$$= \max( ta, tb )$$

**N2 Pulsation damper first stage discharge**

C220006CLC010

**Static Calculation**

PV Elite 24 SP1 Licensee: PPV-Engineering B.V.

FileName : 1-stage Discharge\_LI4734 -----

Nozzle Calcs.: N2 Nozl: 14 1:55pm Jun 21, 2022

$$= \max( 3.609, 6.202 )$$

$$= 6.2017 \text{ mm}$$

Available Nozzle Neck Thickness =  $0.875 * 8.738 = 7.645 \text{ mm}$  --> OK**Nozzle Junction Minimum Design Metal Temperature (MDMT) Calculations:****Nozzle Neck to Flange Weld, min( Curve:B, Curve:A)**

Govrn. thk, tg = 7.645, tr = 0.609, c = 3 mm, E\* = 1  
 Thickness Ratio =  $tr * E*/(tg - c) = 0.131$ , Temp. Reduction = 78 °C

Min Metal Temp. w/o impact per UCS-66, Curve A	-8 °C
Min Metal Temp. at Required thickness (UCS 66.1)	-104 °C
Min Metal Temp. w/o impact per UG-20(f)	-29 °C

**Nozzle-Shell/Head Weld (UCS-66(a)1(b)), Curve: B**

Govrn. thk, tg = 7.645, tr = 0.609, c = 3 mm, E\* = 1  
 Thickness Ratio =  $tr * E*/(tg - c) = 0.131$ , Temp. Reduction = 78 °C

Min Metal Temp. w/o impact per UCS-66, Curve B	-29 °C
Min Metal Temp. at Required thickness (UCS 66.1)	-104 °C

Gov. MDMT of the nozzle to shell joint welded assembly : -104 °C

**Flange MDMT including Temperature reduction per UCS-66.1:**

Unadjusted MDMT of ASME B16.5/47 flanges per UCS-66(c)	-18 °C
Flange MDMT with Temp reduction per UCS-66(b)(1)(-b)	-48 °C

Where the Stress Reduction Ratio per UCS-66(b)(1)(-b) is :  
 Design Pressure/Ambient Rating =  $2.40/5.11 = 0.470$

**Weld Size Calculations, Description: N2**

Intermediate Calc. for nozzle/shell Welds Tmin 5.7376 mm

**Results Per UW-16.1:**

	Required Thickness	Actual Thickness
Nozzle Weld	$4.0163 = 0.7 * t_{min}$	$4.2420 = 0.7 * W_o$ mm

Skipping the nozzle attachment weld strength calculations. Per UW-15(b)(2) the nozzles exempted by UG-36(c)(3)(a) (small nozzles) do not require a weld strength check.

**Maximum Allowable Pressure for this Nozzle at this Location:**

Converged Maximum Allowable Pressure in the Operating case: 3.35 MPa

Note: The MAWP of this junction was limited by the parent Shell/Head.

The Drop for this Nozzle is : 3.0152 mm

The Cut Length for this Nozzle is, Drop + Ho + H + T : 68.4552 mm

**PV Elite is a trademark of Hexagon AB, 2022, All rights reserved.**

N2 Pulsation damper first stage discharge  
C220006CLC010

Static Calculation

PV Elite 24 SP1 Licensee: PPV-Engineering B.V.

FileName : 1-stage Discharge\_LI4734

Nozzle Calcs.: N3 Nozl: 15 1:55pm Jun 21, 2022

**Input, Nozzle Desc: N3**

**From: 20**

Pressure for Reinforcement Calculations	P	2.4000	MPa
Temperature for Internal Pressure	Temp	170	°C
Parent Material		SA-106 B	
Parent Allowable Stress at Temperature	Sv	117.90	MPa
Parent Allowable Stress At Ambient	Sva	117.90	MPa
Inside Diameter of Cylindrical Shell	D	304.74	mm
Shell Finished (Minimum) Thickness	t	8.3400	mm
Shell Internal Corrosion Allowance	c	3.0000	mm
Shell External Corrosion Allowance	co	0.0000	mm
Distance from Bottom/Left Tangent		842.32	mm
User Entered Minimum Design Metal Temperature		-28.89	°C

**Type of Element Connected to the Parent : Nozzle**

Material		SA-106 B	
Material UNS Number		K03006	
Material Specification/Type		Smls. pipe	
Allowable Stress at Temperature	Sn	117.90	MPa
Allowable Stress At Ambient	Sna	117.90	MPa
Diameter Basis (for tr calc only)		Outside	
Layout Angle		270.00	deg
Diameter		38.1000	mm
Size and Thickness Basis		Actual	
Actual Thickness	tn	8.3820	mm
Corrosion Allowance	can	3.0000	mm
Joint Efficiency of Shell Seam at Nozzle	E1	1.00	
Joint Efficiency of Nozzle Neck	En	1.00	
Outside Projection	ho	47.6250	mm
Weld leg size between Nozzle and Pad/Shell	Wo	6.0000	mm
Groove weld depth between Nozzle and Vessel Wgnv		8.3400	mm

The Pressure Design option was Design Pressure + static head.

**Nozzle Sketch (may not represent actual weld type/configuration)**

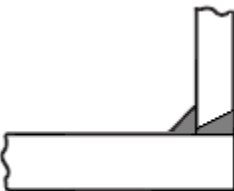

**Abutting/Set-on Nozzle No Pad**

N2 Pulsation damper first stage discharge  
C220006CLC010

Static Calculation

PV Elite 24 SP1 Licensee: PPV-Engineering B.V.

FileName : 1-stage Discharge\_LI4734

Nozzle Calcs.: N3

Noz1: 15 1:55pm Jun 21, 2022

**Reinforcement CALCULATION, Description: N3**

ASME Code, Section VIII, Div. 1, 2021, UG-37 to UG-45

Actual Outside Diameter Used in Calculation	38.100 mm.
Actual Thickness Used in Calculation	8.382 mm

Nozzle input data check completed without errors.

Reqd thk per UG-37(a) of Cylindrical Shell, tr [Int. Press]

$$= P \cdot R / (S_v \cdot E - 0.6 \cdot P) \text{ per UG-27 (c)(1)}$$

$$= 2.4 \cdot 155.4 / (117.9 \cdot 1 - 0.6 \cdot 2.4)$$

$$= 3.2017 \text{ mm}$$

Reqd thk per UG-37(a) of Nozzle Wall, trn [Int. Press]

$$= P \cdot R_o / (S_n \cdot E + 0.4 \cdot P) \text{ per Appendix 1-1 (a)(1)}$$

$$= 2.4 \cdot 19.05 / (117.9 \cdot 1 + 0.4 \cdot 2.4)$$

$$= 0.3846 \text{ mm}$$

**UG-40, Limits of Reinforcement : [Internal Pressure]**

Parallel to Vessel Wall (Diameter Limit)	D1	54.6720 mm
Parallel to Vessel Wall, opening length	d	27.3360 mm
Normal to Vessel Wall (Thickness Limit), no pad	Tlnp	13.3500 mm

*Taking a UG-36(c)(3)(a) exemption for nozzle: N3.*

*This calculation is valid for nozzles that meet all the requirements of paragraph UG-36. Please check the Code carefully, especially for nozzles that are not isolated or do not meet Code spacing requirements. To force the computation of areas for small nozzles go to Tools->Configuration and check the box to force the UG-37 small nozzle area calculation.*

**UG-45 Minimum Nozzle Neck Thickness Requirement: [Int. Press.]**

Wall Thickness for Internal/External pressures	ta = 3.3846 mm
Wall Thickness per UG16(b),	tr16b = 4.5000 mm
Wall Thickness, shell/head, internal pressure	trb1 = 6.2017 mm
Wall Thickness	tb1 = max(trb1, tr16b) = 6.2017 mm
Wall Thickness	tb2 = max(trb2, tr16b) = 4.5000 mm
Wall Thickness per table UG-45	tb3 = 6.1200 mm

Determine Nozzle Thickness candidate [tb]:

$$= \min[ tb3, \max( tb1, tb2 ) ]$$

$$= \min[ 6.12, \max( 6.202, 4.5 ) ]$$

$$= 6.1200 \text{ mm}$$

Minimum Wall Thickness of Nozzle Necks [tUG-45]:

$$= \max( ta, tb )$$

$$= \max( 3.385, 6.12 )$$

$$= 6.1200 \text{ mm}$$

Available Nozzle Neck Thickness = 8.3820 mm --> OK

**Nozzle Junction Minimum Design Metal Temperature (MDMT) Calculations:**

**Nozzle-Shell/Head Weld (UCS-66(a)1(b)), Curve: B**

Govrn. thk, tg = 8.34, tr = 3.202, c = 3 mm, E\* = 1

Thickness Ratio = tr \* E\*/(tg - c) = 0.6, Temp. Reduction = 23 °C

N2 Pulsation damper first stage discharge

C220006CLC010

Static Calculation

PV Elite 24 SP1 Licensee: PPV-Engineering B.V.

FileName : 1-stage Discharge\_LI4734 -----

Nozzle Calcs.: N3 Nozl: 15 1:55pm Jun 21,2022

Min Metal Temp. w/o impact per UCS-66, Curve B -29 °C

Min Metal Temp. at Required thickness (UCS 66.1) -48 °C

Gov. MDMT of the nozzle to shell joint welded assembly : -48 °C

Weld Size Calculations, Description: N3

Intermediate Calc. for nozzle/shell Welds Tmin 5.3820 mm

**Results Per UW-16.1:**

	Required Thickness	Actual Thickness
Nozzle Weld	3.7674 = 0.7 * tmin.	4.2420 = 0.7 * Wo mm

Skipping the nozzle attachment weld strength calculations. Per UW-15(b)(2) the nozzles exempted by UG-36(c)(3)(a) (small nozzles) do not require a weld strength check.

**Maximum Allowable Pressure for this Nozzle at this Location:**

Converged Maximum Allowable Pressure in the Operating case: 3.35 MPa

Note: The MAWP of this junction was limited by the parent Shell/Head.

The Drop for this Nozzle is : 1.1956 mm

The Cut Length for this Nozzle is, Drop + Ho + H + T : 57.1605 mm

**PV Elite is a trademark of Hexagon AB, 2022, All rights reserved.**

e