





OWNER:  شرکت سست و سویی توهمه ایرانیان (سهامی عامه)	BUSHEHR PETROCHEMICAL COMPANY MEG PLANT						EPC CONTRACTOR:  Chagalesh-Enerechimi-Steam Joint Venture BUPC-MEG PLANT PROJECT		
	AFTER COOLER MECHANICAL STRENGHT CALCULATION FOR NITROGEN GAS BOOSTER								
MC :  شرکت سست و سویی توهمه ایرانیان (سهامی عامه)	Project	Area	Phase	Unit	Dis.	Doc.	Seq.	Contract No : 52-98/445	
Owner Document Number: 17811-24A	BU	20	VD	303	ME	CAL	0016	Rev.:	Page
								04	1 of 124

AFTER COOLER MECHANICAL STRENGHT CALCULATION FOR NITROGEN GAS BOOSTER

04	13/07/2022	Approved for Construction	KP	CL	JR	
03	16/06/2022	For approval	KP	LdM	JR	
02	09/05/2022	For approval	KP	LdM	JR	
01	05/05/2022	For approval	KP	LdM	JR	
00	17/02/2022	For approval	KP	LdM	JR	
Rev.	Date	Purpose of Issue	Prepared	Checked	Approved	AC Code
					Class: 1	Phase: P

Table of Contents

Cover Sheet.....	2
Vessel Design Summary:	3
Nozzle Summary:.....	5
Nozzle Schedule:	7
Bill of Material:.....	8
MDMT Summary:.....	9
Warnings and Errors:.....	11
Input Echo:.....	12
XY Coordinate Calculations:	19
Flg Calc [Int P]: Channel Fla.....	20
Flg Calc [Int P]: Shell Fl. 1.....	25
Flg Calc [Int P]: Shell Fl. 2.....	30
Flg Calc [Int P]: Cover head.....	35
Internal Pressure Calculations:.....	39
External Pressure Calculations:.....	44
Element and Detail Weights:	46
Nozzle Flange MAWP:.....	48
Center of Gravity Calculation:.....	49
Nozzle Calcs.: Noz N1 Fr10 - T.....	50
Nozzle Calcs.: Noz N2 Fr10.....	53
Nozzle Calcs.: Noz N3 - Shell.....	56
Nozzle Calcs.: Noz N4 - Shell.....	59

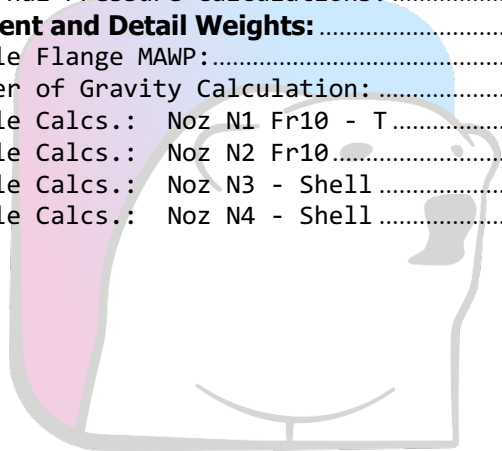

Strength Calculation PV-Elite
IWS-Monje Heat Exchangers GmbH
Wittener Str. 102, 44789 Bochum, Germany

Reference # : Project 17811
Revision # : 00
Client Name : Airpack Nederland BV
Drawing # : K12-3108

DESIGN CALCULATION

In Accordance with ASME Section VIII Division 1

ASME Code Version : 2021

Analysis Performed by : IWS-Monje Heat Exchangers GmbH

Job File : Y:\Airpack\BK12-3108-L800_Airpack-17811_Rev00.pvdb

Date of Analysis : May 5, 2022 11:11am

PV Elite 24, January 2022



Strength Calculation PV-Elite
 IWS-Monje Heat Exchangers GmbH
 Wittener Str. 102, 44789 Bochum, Germany
 PV Elite 24 Licensee: IWS-Monje? Heat Exchangers GmbH
 FileName : BK12-3102-L800_Airpack-17811_Rev00 -----
 Vessel Design Summary: Step: 20 11:11am May 5,2022

Vessel Design Summary:

ASME Code, Section VIII Division 1, 2021

Diameter Spec : 160.000 x 141.300 mm OD
 Vessel Design Length, Tangent to Tangent 962.85 mm

Specified Datum Line Distance 0.00 mm

Shell Side Design Temperature 210 °C
 Channel Side Design Temperature 95 °C

Shell Side Design Pressure 2.500 MPa
 Channel Side Design Pressure 1.000 MPa

Shop Shell Side Test Pressure 3.750 MPa
 Shop Channel Side Test Pressure 1.500 MPa

Wind Design Code No Wind Loads
 Earthquake Design Code No Seismic

Materials of Construction:

Component Type	Material	Class	Thickness	UNS #	Normal ized	Impact Tested
Shell	SA-516 70	K02700	No	No
Shell	SA-312 TP316	S31600	No	No
Cover	SA-516 70	K02700	No	No
Flange	SA-516 70	K02700	No	No
Flange	SA-182 F316	...	> 5	S31600	No	No
Nozzle	SA-106 B	K03006	No	No
Nozzle	SA-312 TP316	S31600	No	No
Nozzle Flg	SA-182 F316	...	> 5	S31600	No	No
Tubes	SB-111 061	061	...	C70600	No	No
Tubesheet	SB-148 M01	M01	...	C95200	No	No
Flg Bolting	SA-193 B7	...	<= 2 1/2	G41400	No	No

Normalized is determined based on the UCS-66 material curve selection and Figure UCS-66.
 Impact Tested is based on material selection and material data properties.

Element Pressures and MAWP (MPa & mm):

Element Description or Type	Design Pressure + Stat. head	Ext. Press.	Element M.A.W.P	Total Corrosion Allowance	Str. Flg. Gov.	In Creep Range
Channel head flat	1.000	0.10	26.000	1.0000	N/A	No
Channel head cylinder	1.000	0.10	22.000	1.0000	N/A	No
Channel head flange	1.000	0.10	2.000	1.0000	N/A	No
Shell flange ring 1	1.000	0.10	2.000	0.0000	N/A	No
Main Shell	2.500	0.10	6.000	0.0000	N/A	No
Shell flange ring 2	1.000	0.10	2.000	0.0000	N/A	No
Cover head	1.000	0.10	3.000	1.0000	N/A	No

Strength Calculation PV-Elite
 IWS-Monje Heat Exchangers GmbH
 Wittener Str. 102, 44789 Bochum, Germany
 PV Elite 24 Licensee: IWS-Monje? Heat Exchangers GmbH
 FileName : BK12-3102-L800_Airpack-17811_Rev00 -----
 Vessel Design Summary: Step: 20 11:11am May 5,2022

Element Types and Properties:

Element Type	"To" Elev mm	Element Length mm	Nominal Thickness mm	Finished Thickness mm	Reqd Thk Internal mm	Reqd Thk External mm	Long Eff	Circ Eff
Wld Flat	27.0	27.0	27.0	27.0	6.1	...	1.00	1.00
Cylinder	57.0	30.0	13.0	13.0	3.5	1.3	1.00	1.00
Body Flg	57.0	18.0	18.0	18.0	14.2	10.4	1.00	1.00
Body Flg	134.5	36.0	...	18.0	12.1	7.0	1.00	1.00
Cylinder	888.3	753.8	...	3.4	1.5	1.0	1.00	1.00
Body Flg	924.3	36.0	...	18.0	12.1	7.0	1.00	1.00
Body Flg	962.8	25.0	...	25.0	10.0	6.9	1.00	1.00

Weights:

Fabricated - Bare W/O Removable Internals	55.5	kg
Shop Test - Fabricated + Water (Full)	67.2	kg
Shipping - Fab. + Rem. Intls.+ Shipping App.	55.5	kg
Erected - Fab. + Rem. Intls.+ Insul. (etc)	55.5	kg
Empty - Fab. + Intls. + Details + Wghts.	55.5	kg
Operating - Empty + Operating Liquid (No CA)	55.5	kg
Field Test - Empty Weight + Water (Full)	67.2	kg

PV Elite is a trademark of Hexagon AB, 2022, All rights reserved.

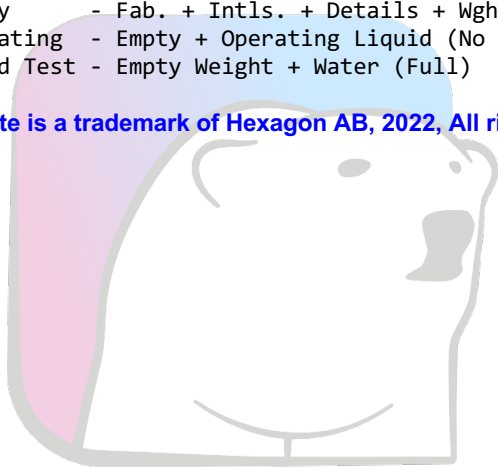

IWS -
 MONJÉ
 HEAT EXCHANGERS

Strength Calculation PV-Elite
 IWS-Monje Heat Exchangers GmbH
 Wittener Str. 102, 44789 Bochum, Germany
 PV Elite 24 Licensee: IWS-Monje? Heat Exchangers GmbH
 FileName : BK12-3102-L800_Airpack-17811_Rev00 -----
 Nozzle Summary: Step: 18 11:11am May 5,2022

Nozzle Calculation Summary (MPa & mm):

Description	MAWP	Ext	MAPNC	UG-45	[tr]	Weld Path	Areas or Stresses
Noz N1 Fr10 - T	1	OK	4.12	OK	No Calc[*]
Noz N2 Fr10	1	OK	4.12	OK	No Calc[*]
Noz N3 - Shell	2	OK	1.50	OK	No Calc[*]
Noz N4 - Shell	2	OK	1.50	OK	No Calc[*]

Nozzle MAWP Summary:

Minimum MAWP Nozzles : 2 Nozzle : Noz N3 - Shell [Shellside]
 Minimum MAWP Nozzles : 1 Nozzle : Noz N1 Fr10 - T [Tubewise]

[*] - This was a small opening and the areas were not computed.

Note: MAWPs (Internal Case) shown above are at the High Point.

Multiple output lines for the same nozzle indicates required Code calculations in both the longitudinal and circumferential planes of reinforcement where applicable.

Check the Spatial Relationship between the Nozzles:

From Node	Nozzle Description	X Coordinate mm	Layout Angle deg	Dia. Limit mm
10	Noz N1 Fr10 - Tu	0.000	90.000	92.000
10	Noz N2 Fr10	0.000	270.000	92.000
50	Noz N3 - Shelli	206.525	270.000	104.600
50	Noz N4 - Shello	826.525	90.000	104.600

The nozzle spacing is computed by the following:

$$= \sqrt{l_l^2 + l_c^2} \text{ where}$$

l_l - Arc length along the inside vessel surface in the long. direction.

l_c - Arc length along the inside vessel surface in the circ. direction

If any interferences/violations are found, they will be noted below.

No interference violations have been detected!

Checking Multiple Nozzles on Flat Head per ASME Sec. VIII Div. 1 UG-39

Comparing Nozzles on Element: Channel head flat

UG-39 Average Nozzle Diameter and Ligament Checks:

Nozzle Pair Description	Avg. dia. mm	Head Dia. /4 mm	Ligament Width mm	Min. dn /4 mm
Noz N1 Fr10 - Tu & No	32	40	52	8

Strength Calculation PV-Elite
 IWS-Monje Heat Exchangers GmbH
 Wittener Str. 102, 44789 Bochum, Germany
 PV Elite 24 Licensee: IWS-Monje? Heat Exchangers GmbH
 FileName : BK12-3102-L800_Airpack-17811_Rev00 -----
 Nozzle Summary: Step: 18 11:11am May 5,2022

UG-39 Nozzle Spacing and Average Area Checks:

Nozzle Pair Description	Center Spacing mm	Avg. dia. * 1.25 mm	Avg. Area Available mm^2	Avg. Area Reqd. mm^2
Noz N1 Fr10 - Tu & No	92	40	No Calc	No Calc

UG-39 Nozzle Diameter and Distance to Edge Checks:

Nozzle Description	Nozzle dia. mm	Head Dia. /2 mm	Distance from Edge mm	Nozzle dia./4 mm
Noz N1 Fr10 - Tu	32	80	27	8
Noz N2 Fr10	32	80	27	8

No Multiple Nozzle spacing violations detected!

PV Elite is a trademark of Hexagon AB, 2022, All rights reserved.

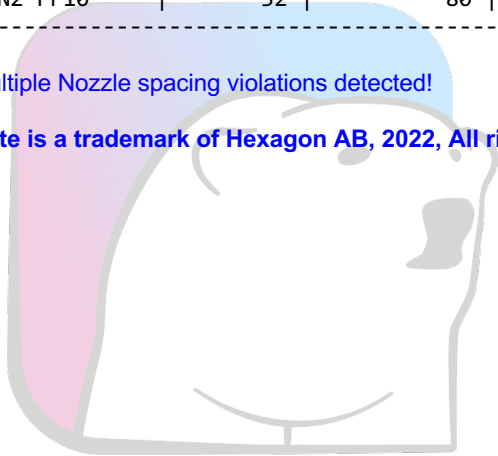

IWS-
MONJÉ
 HEAT EXCHANGERS

Strength Calculation PV-Elite

IWS-Monje Heat Exchangers GmbH

Wittener Str. 102, 44789 Bochum, Germany

PV Elite 24

Licensee: IWS-Monje? Heat Exchangers GmbH

FileName : BK12-3102-L800_Airpack-17811_Rev00

Nozzle Schedule:

Step: 17 11:11am May 5,2022

Nozzle Schedule:

Description	Nominal or Actual Size	Schd or FVC Type	Flg Type	Nozzle O/Dia mm	Wall Thk mm	Reinforcing Pad Diameter	Pad Thk mm	Cut Length mm	Flg Class
Noz N1 Fr10 - Tu	40 mm	Actual	None	40.0	5.000	7	...
Noz N2 Fr10	40 mm	Actual	None	40.0	5.000	7	...
Noz N3 - Shell i	60 mm	Actual	WNF	60.3	4.000	4	300
Noz N4 - Shell o	60 mm	Actual	WNF	60.3	4.000	4	300

General Notes for the above table:

The Cut Length is the Outside Projection + Inside Projection + Drop + In Plane Shell Thickness. This value does not include weld gaps, nor does it account for shrinkage.

In the case of Oblique Nozzles, the Outside Diameter must be increased. The Re-Pad WIDTH around the nozzle is calculated as follows:
Width of Pad = (Pad Outside Dia. (per above) - Nozzle Outside Dia.)/2

For hub nozzles, the thickness and diameter shown are those of the smaller and thinner section.

Nozzle Material and Weld Fillet Leg Size Details (mm):

Description	Material	Shl Grve Weld	Noz Shl/Pad Weld	Pad OD Weld	Pad Grve Weld	Inside Weld
Noz N1 Fr10	SA-106 B	...	10.000
Noz N2 Fr10	SA-106 B	...	10.000
Noz N3 - Sh	SA-312 TP316	...	10.000
Noz N4 - Sh	SA-312 TP316	3.400	10.000

Note: The Outside projections below do not include the flange thickness.

Nozzle Miscellaneous Data:

Description	Elev/Distance From Datum mm	Layout Angle deg	Proj Outside mm	Proj Inside mm	Installed in Component
Noz N1 Fr10 - Tu	...	90.0	50.00	0.00	Channel head fla
Noz N2 Fr10	...	270.0	50.00	0.00	Channel head fla
Noz N3 - Shell i	206.525	270.0	39.00	0.00	Main Shell
Noz N4 - Shell o	826.525	90.0	39.00	0.00	Main Shell

PV Elite is a trademark of Hexagon AB, 2022, All rights reserved.

Strength Calculation PV-Elite
 IWS-Monje Heat Exchangers GmbH
 Wittener Str. 102, 44789 Bochum, Germany
 PV Elite 24 Licensee: IWS-Monje? Heat Exchangers GmbH
 FileName : BK12-3102-L800_Airpack-17811_Rev00 -----
 Bill of Material: Step: 16 11:11am May 5,2022

Bill of Materials:

QTY	DESCRIPTION	MATERIAL
1	FLAT HEAD: 27.0mm THK X 160.0mm OD	SA-516 70
1	CYLINDER: 13.0mm THK X 134.0mm ID X 30.0mm	SA-516 70
1	BODY FLANGE: 18.0mm THK X 220.0mm OD	SA-516 70
2	BODY FLANGE: 18.0mm THK X 220.0mm OD	SA-182 F316
1	CYLINDER: 3.4mm THK X 134.5mm ID X 753.8mm	SA-312 TP316
1	BODY FLANGE: 25.0mm THK X 220.0mm OD	SA-516 70
1	TUBESHEET: 165.0mm X 28.0mm THK	SB-148 M01
72	TUBES: 830.0mm X 8.0mm DIA X 0.5mm THK	SB-111 061
1	FLOATING TUBESHEET: 132.2mm X 28.0mm THK	SB-148 M01
2	GASKET: 165.0mm OD X 155.0mm ID	...
8	BODY FLANGE BOLTS: 12.0mm DIA	SA-193 B7
16	NUTS FOR BODY FLANGE BOLTS: 12.0mm DIA	...
1	NAMEPLATE	...

PV Elite is a trademark of Hexagon AB, 2022, All rights reserved.

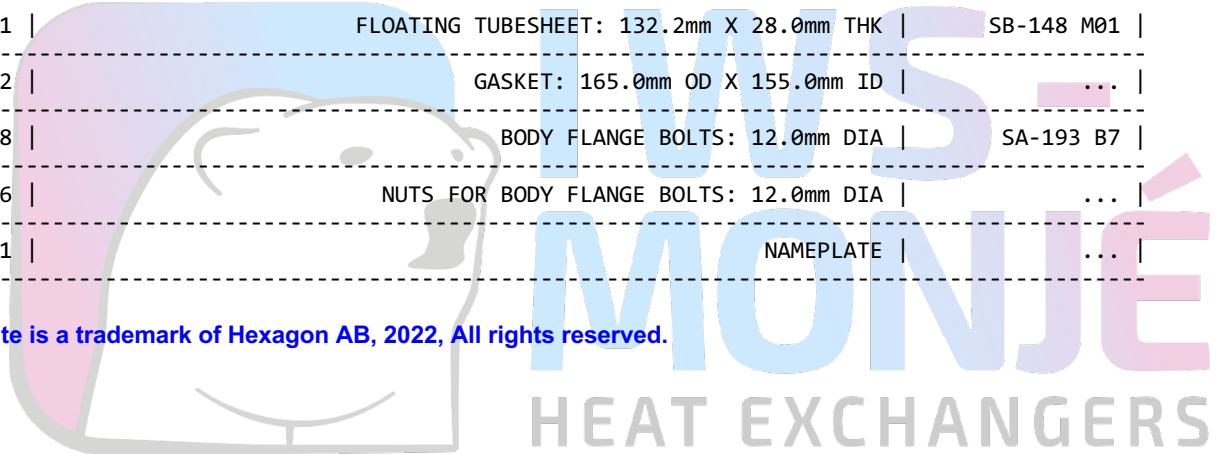

Strength Calculation PV-Elite
 IWS-Monje Heat Exchangers GmbH
 Wittener Str. 102, 44789 Bochum, Germany
 PV Elite 24 Licensee: IWS-Monje? Heat Exchangers GmbH
 FileName : BK12-3102-L800_Airpack-17811_Rev00 -----
 MDMT Summary: Step: 19 11:11am May 5,2022

Minimum Design Metal Temperature Results Summary (°C):

Description	Curve	Basic MDMT	Reduced MDMT	UG-20(f) MDMT	Thickness ratio	Gov Thk mm	E*	PWHT reqd
Main Shell [16]		-196						
Noz N3 - Shel[15]		-196						
Nozzle Flg [5]		-196						
Noz N4 - Shel[15]		-196						
Nozzle Flg [5]		-196						
Nozl. Bolting[22]		-48			1.000	63.500	1.00	No
Tubesheet: SS[13]		-18						No

Warmest MDMT: -18

Shell flange [11]		-196						
Shell flange [11]		-196						
Cover head [11]	B	-29	-48	-29	0.381	6.250	1.00	No
Channel head [12]	B	-21	-104	-29	0.196	13.000	1.00	No
Channel head c[8]	B	-21	-104	-29	0.208	13.000	1.00	No
Noz N1 Fr10 - [1]	B	-29	-104	-29	0.042	5.000	1.00	No
Noz N2 Fr10 [1]	B	-29	-104	-29	0.042	5.000	1.00	No
Tubesheet: CS[14]		-18						No
Bolting [21]		-48						

Warmest MDMT: -18 -48

Exchanger Side	Computed MDMT	Required MDMT	Pass/Fail
Shell	-18.0	-10.0	Pass
Channel/Tube	-18.0	-10.0	Pass

Notes:

- [!] - This was an impact tested material.
- [1] - Governing Nozzle Weld.
- [4] - ASME Flange MDMT Calcs; Thickness ratio per UCS-66(b)(1)(-c).
- [5] - ASME Flange MDMT Calcs; Thickness ratio per UCS-66(b)(1)(-b).
- [6] - MDMT Calculations at the Shell/Head Joint.
- [7] - MDMT Calculations for the Straight Flange.
- [8] - Cylinder/Cone/Flange Junction MDMT.
- [9] - Calculations in the Spherical Portion of the Head.
- [10] - Calculations in the Knuckle Portion of the Head.
- [11] - Calculated (Body Flange) Flange MDMT.
- [12] - Calculated Flat Head MDMT per UCS-66.3
- [13] - Tubesheet MDMT, shell side, if applicable
- [14] - Tubesheet MDMT, tube side, if applicable
- [15] - Nozzle Material
- [16] - Shell or Head Material
- [17] - Impact Testing required
- [18] - Impact Testing not required, see UCS-66(b)(3)
- [20] - Cylinder/Cone Junction MDMT based on Longitudinal Stress considerations
- [21] - Body Flange Bolting Material
- [22] - Nozzle Flange Bolting Material
- [23] - Stiffening Ring to Shell Weld

Strength Calculation PV-Elite
IWS-Monje Heat Exchangers GmbH
Wittener Str. 102, 44789 Bochum, Germany
PV Elite 24 Licensee: IWS-Monje Heat Exchangers GmbH
FileName : BK12-3102-L800_Airpack-17811_Rev00 -----
MDMT Summary: Step: 19 11:11am May 5,2022

[24] - Saddle to Shell Weld

UG-84(b)(2) was not considered.

UCS-66(g) was not considered.

UCS-66(i) was not considered.

Notes:

Impact test temps were not entered in and not considered in the analysis.

UCS-66(i) applies to impact tested materials not by specification and

UCS-66(g) applies to materials impact tested per UG-84.1 General Note (c).

The Basic MDMT includes the (30F) PWHT credit if applicable.

PV Elite is a trademark of Hexagon AB, 2022, All rights reserved.

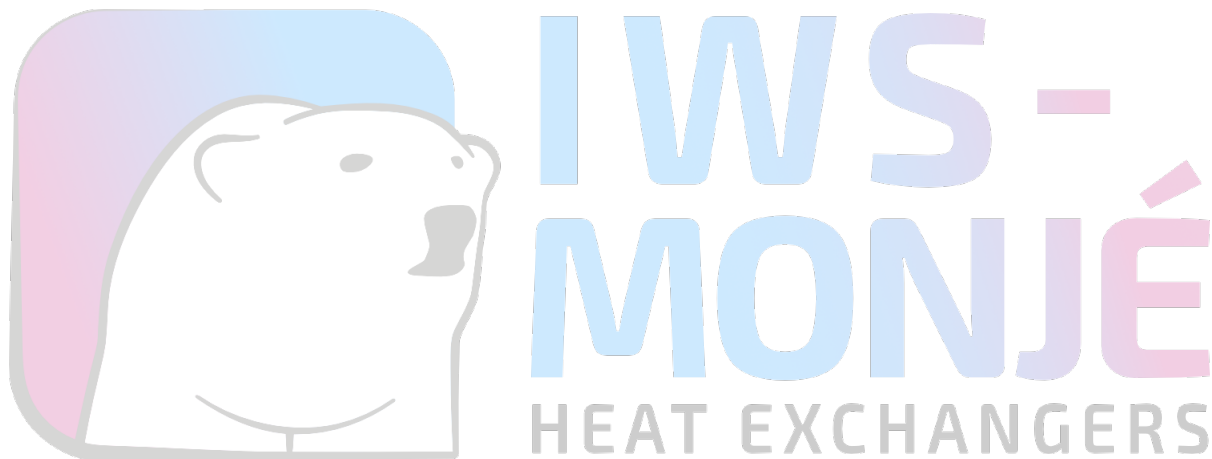

Strength Calculation PV-Elite
IWS-Monje Heat Exchangers GmbH
Wittener Str. 102, 44789 Bochum, Germany
PV Elite 24 Licensee: IWS-Monj? Heat Exchangers GmbH
FileName : BK12-3102-L800_Airpack-17811_Rev00 -----
Warnings and Errors: Step: 0 11:11am May 5,2022

Class From To : Basic Element Checks.

Class From To: Check of Additional Element Data

Please insure the C factor entered is in accordance with Figure UG-34.

There were no geometry errors or warnings.

PV Elite performs all calculations internally in Imperial Units to remain compliant with the ASME Code and any built in assumptions in the ASME Code formulas. The finalized results are reflected to show the set of selected units for this analysis.

PV Elite is a trademark of Hexagon AB, 2022, All rights reserved.

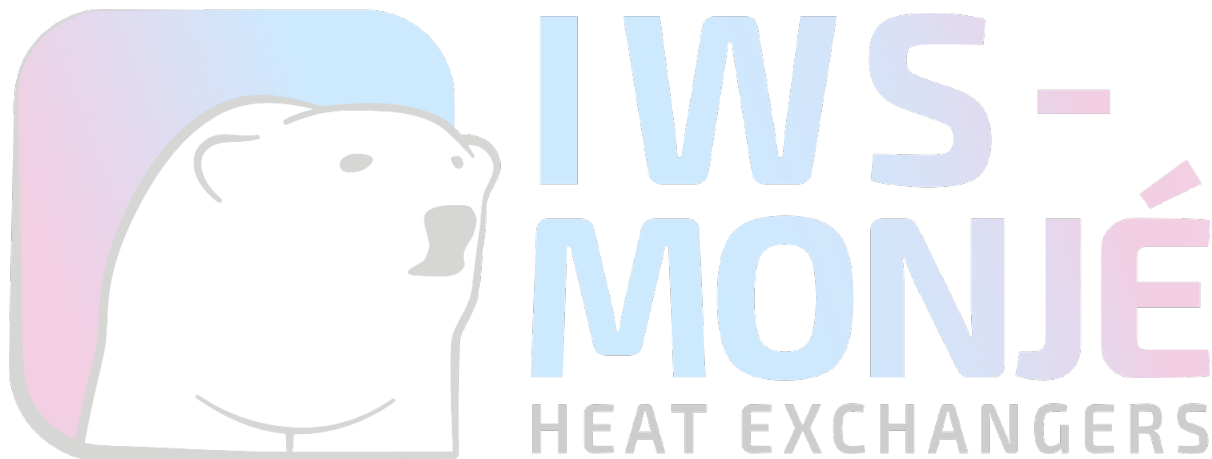

Strength Calculation PV-Elite
 IWS-Monje Heat Exchangers GmbH
 Wittener Str. 102, 44789 Bochum, Germany
 PV Elite 24 Licensee: IWS-Monje? Heat Exchangers GmbH
 FileName : BK12-3102-L800_Airpack-17811_Rev00 -----
 Input Echo: Step: 1 11:11am May 5,2022

Units used in this Analysis (SI_ASME_Unicode):

Name	System Unit	Constant	User Unit
Length	Feet	304.8000	mm
Force	Pounds	4.4480	N
Mass	Pounds	0.4536	kg
Area	sq. inches	645.1600	mm^2
Moment	ft. lbs.	1356.3000	N-mm
Stress	lbs./sq.in.	0.0069	MPa
Temperature	Degrees F	0.5556	°C
Pressure	psig	0.0069	MPa
Elast. Modulus	lbs./sq.in.	0.0069	MPa
Pipe Density	lbs./cu.in.	0.0277	kg/cm^3
Ins. Density	lbs./cu.ft.	0.1602E-04	kg/cm^3
Fluid Density	lbs./cu.ft.	0.1602E-04	kg/cm^3
Wind Speed	miles/hr	1.6093	km/hr
Tray Weight	lbs./sq.ft.	0.0005	kgs/cm^2
Inertia	in.**4	416231.0000	mm^4
G Load	G's	1.0000	g's
Wind Load	lbs./sq.ft.	0.0479	kPa
Elevation	Feet	304.8000	mm
Volume	in.**3	0.0164	ltr
Diameter	inches	25.4000	mm
Thickness	inches	25.4000	mm

PV Elite Vessel Analysis Program: Input Data

Strength Calculation PV-Elite
 IWS-Monje Heat Exchangers GmbH
 Wittener Str. 102, 44789 Bochum, Germany

Exchanger Design Pressures and Temperatures

Shell Side Design Pressure	2.5	MPa
Channel Side Design Pressure	1	MPa
Shell Side Design Temperature	210.0	°C
Channel Side Design Temperature	95.0	°C
Radiography, Shell Side	RT-3	
Radiography, Channel Side	RT-1	
Service Type, Shell Side	Air/Water/Steam	
Service Type, Channel Side	Air/Water/Steam	
MDMT (CET), Shell Side	-10.0	°C
MDMT (CET), Tube Side	-10.0	°C
User defined MAWP, Shell Side	2.5	MPa
User defined MAWP, Channel Side	1	MPa
User defined MAPnc, Shell Side	2.5	MPa
User defined MAPnc, Channel Side	1	MPa
User defined Test Pres., Shell Side	3.75	MPa
User defined Test Pres., Channel Side	1.5	MPa

Projection of Nozzle from Vessel Top	0	mm
Projection of Nozzle from Vessel Bottom	0	mm

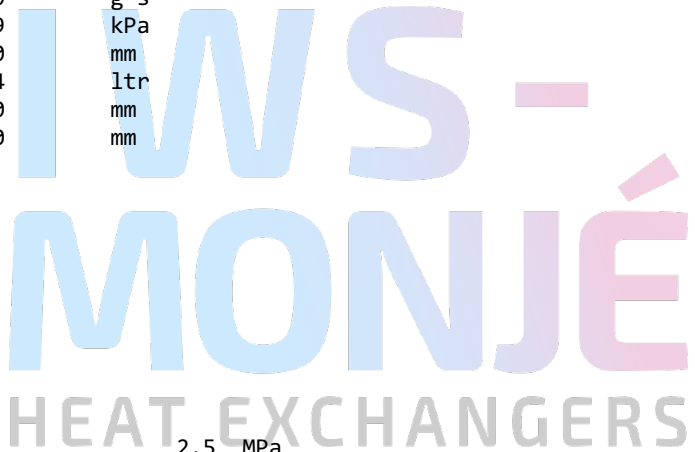

Strength Calculation PV-Elite

IWS-Monje Heat Exchangers GmbH

Wittener Str. 102, 44789 Bochum, Germany

PV Elite 24 Licensee: IWS-Monje? Heat Exchangers GmbH

FileName : BK12-3102-L800_Airpack-17811_Rev00 -----

Input Echo: Step: 1 11:11am May 5,2022

Type of Construction	Welded
Use Higher Longitudinal Stresses (Flag)	N
Select t for Internal Pressure (Flag)	N
Select t for External Pressure (Flag)	N
Select t for Axial Stress (Flag)	N
Select Location for Stiff. Rings (Flag)	N
Consider Vortex Shedding	N

Shop Pressure Test:

Type of Pressure Test	User Entered Pressure
Pressure Test Position	Horizontal
Load Case 1	NP+EW+WI+FW+BW
Load Case 2	NP+EW+EE+FS+BS
Load Case 3	NP+OW+WI+FW+BW
Load Case 4	NP+OW+EQ+FS+BS
Load Case 5	NP+HW+HI
Load Case 6	NP+HW+HE
Load Case 7	IP+OW+WI+FW+BW
Load Case 8	IP+OW+EQ+FS+BS
Load Case 9	EP+OW+WI+FW+BW
Load Case 10	EP+OW+EQ+FS+BS
Load Case 11	HP+HW+HI
Load Case 12	HP+HW+HE
Load Case 13	IP+WE+EW
Load Case 14	IP+WF+CW
Load Case 15	IP+VO+OW
Load Case 16	IP+VE+EW
Load Case 17	NP+VO+OW
Load Case 18	FS+BS+IP+OW
Load Case 19	FS+BS+EP+OW
Load Case 20	BL+IP+OW
Wind Design Code	No Wind Loads
Seismic Design Code	No Seismic
Design Pressure + Static Head	Y
Consider MAP New and Cold in Noz. Design	N
Consider External Loads for Nozzle Des.	Y
Use ASME VIII-1 Appendix 1-9	N
Perform Blast Load Analysis	No
Material Database Year	Current w/Addenda or Code Year

Configuration Directives:

Do not use Nozzle MDMT Interpretation VIII-1 01-37	No
Use Table G instead of exact equation for "A"	Yes
Shell Head Joints are Tapered	Yes
Compute "K" in corroded condition	Yes
Use Code Case 2286	No
Use the MAWP to compute the MDMT	Yes
For thickness ratios ≤ 0.35 , MDMT will be -155F (-104C)	Yes
For PWHT & P1 Materials the MDMT can be $< -55F (-48C)$	No
Using Metric Material Databases, ASME II D	No

Strength Calculation PV-Elite
 IWS-Monje Heat Exchangers GmbH
 Wittener Str. 102, 44789 Bochum, Germany
 PV Elite 24 Licensee: IWS-Monje? Heat Exchangers GmbH
 FileName : BK12-3102-L800_Airpack-17811_Rev00 -----
 Input Echo: Step: 1 11:11am May 5,2022

Calculate B31.3 type stress for Nozzles with Loads Yes
 Reduce the MDMT due to lower membrane stress Yes
 Consider Longitudinal Stress in MDMT Calculations Yes

Complete Listing of Vessel Elements and Details:

Element From Node 10
 Element To Node 20
 Element Type Flat
 Description Channel head flat
 Distance "FROM" to "TO" 27 mm
 Element Outside Diameter 160 mm
 Element Thickness 27 mm
 Internal Corrosion Allowance 1 mm
 Nominal Thickness 27 mm
 External Corrosion Allowance 0 mm
 Design Internal Pressure 1 MPa
 Design Temperature Internal Pressure 95 °C
 Design External Pressure 0.1013 MPa
 Design Temperature External Pressure 95 °C
 Effective Diameter Multiplier 1.0
 Material Name SA-516 70
 Allowable Stress, Ambient 137.9 MPa
 Allowable Stress, Operating 137.9 MPa
 Allowable Stress, Hydrotest 179.27 MPa
 Material Density 0.00775 kg/cm³
 P Number Thickness 31.75 mm
 Yield Stress, Operating 239.7 MPa
 UCS-66 Chart Curve Designation B
 External Pressure Chart Name CS-2
 UNS Number K02700
 Product Form Plate
 Efficiency, Longitudinal Seam 1.0
 Efficiency, Circumferential Seam 1.0
 Flat Head Attachment Factor 0.2
 Small diameter if Non-Circular 0 mm
 Weld is pre-Heated No

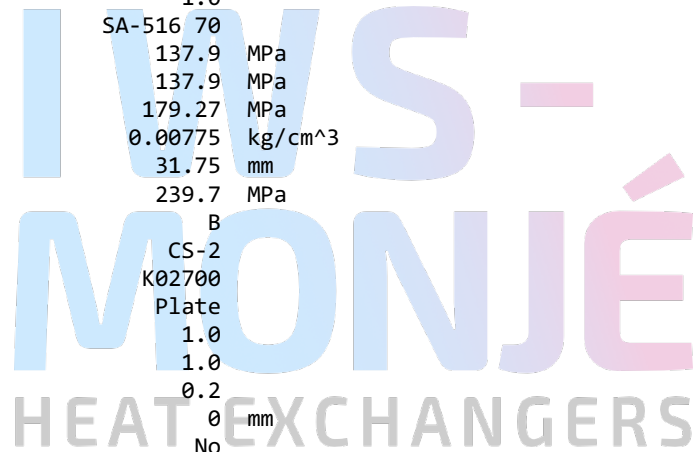

Element From Node 10
 Detail Type Nozzle
 Detail ID Noz N1 Fr10 - Tu
 Dist. from "FROM" Node / Offset dist 46 mm
 Nozzle Diameter 40 mm
 Nozzle Schedule 40
 Nozzle Class None
 Layout Angle 90.0
 Blind Flange (Y/N) N
 Weight of Nozzle (Used if > 0) 3.0184 N
 Grade of Attached Flange None
 Nozzle Matl SA-106 B

Element From Node 10
 Detail Type Nozzle
 Detail ID Noz N2 Fr10
 Dist. from "FROM" Node / Offset dist 46 mm
 Nozzle Diameter 40 mm
 Nozzle Schedule 40

Strength Calculation PV-Elite
 IWS-Monje Heat Exchangers GmbH
 Wittener Str. 102, 44789 Bochum, Germany
 PV Elite 24 Licensee: IWS-Monj? Heat Exchangers GmbH
 FileName : BK12-3102-L800_Airpack-17811_Rev00 -----
 Input Echo: Step: 1 11:11am May 5,2022

Nozzle Class	None
Layout Angle	270.0
Blind Flange (Y/N)	N
Weight of Nozzle (Used if > 0)	0 N
Grade of Attached Flange	None
Nozzle Matl	SA-106 B

Element From Node	20
Element To Node	30
Element Type	Cylinder ! Atype
Description	Channel head cylinder
Distance "FROM" to "TO"	30 mm
Element Outside Diameter	160 mm
Element Thickness	13 mm
Internal Corrosion Allowance	1 mm
Nominal Thickness	13 mm
External Corrosion Allowance	0 mm
Design Internal Pressure	1 MPa
Design Temperature Internal Pressure	95 °C
Design External Pressure	0.1013 MPa
Design Temperature External Pressure	95 °C
Effective Diameter Multiplier	1.0
Material Name	SA-516 70
Efficiency, Longitudinal Seam	1.0
Efficiency, Circumferential Seam	1.0
Weld is pre-Heated	No

Element From Node	30
Element To Node	40
Element Type	Flange
Description	Channel head flange
Distance "FROM" to "TO"	18 mm
Flange Inside Diameter	132.6 mm
Element Thickness	18 mm
Internal Corrosion Allowance	1 mm
Nominal Thickness	18 mm
External Corrosion Allowance	0 mm
Design Internal Pressure	1 MPa
Design Temperature Internal Pressure	95 °C
Design External Pressure	0.1013 MPa
Design Temperature External Pressure	95 °C
Effective Diameter Multiplier	1.0
Material Name	SA-516 70
Perform Flange Stress Calculation (Y/N)	Y
Weld is pre-Heated	No

Element From Node	40
Element To Node	50
Element Type	Flange
Description	Shell flange ring 1
Distance "FROM" to "TO"	36 mm

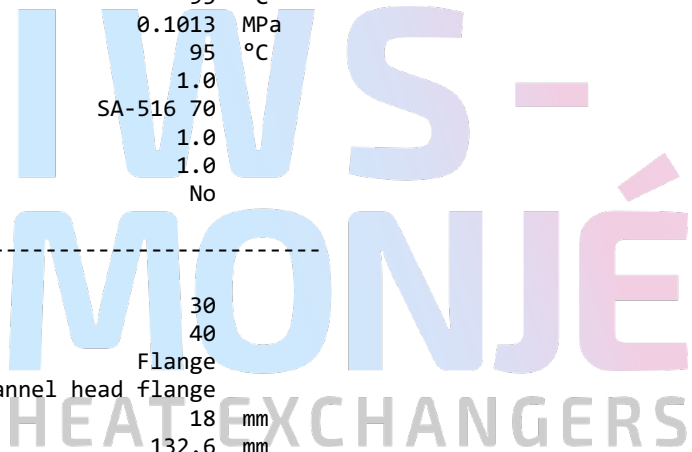

Strength Calculation PV-Elite
 IWS-Monje Heat Exchangers GmbH
 Wittener Str. 102, 44789 Bochum, Germany
 PV Elite 24 Licensee: IWS-Monje? Heat Exchangers GmbH
 FileName : BK12-3102-L800_Airpack-17811_Rev00 -----
 Input Echo: Step: 1 11:11am May 5,2022

Flange Inside Diameter	133	mm
Element Thickness	18	mm
Internal Corrosion Allowance	0	mm
Nominal Thickness	0	mm
External Corrosion Allowance	0	mm
Design Internal Pressure	1	MPa
Design Temperature Internal Pressure	210	°C
Design External Pressure	0.1013	MPa
Design Temperature External Pressure	210	°C
Effective Diameter Multiplier	1.0	
Material Name	SA-182 F316	
Allowable Stress, Ambient	137.9	MPa
Allowable Stress, Operating	131.56	MPa
Allowable Stress, Hydrotest	179.27	MPa
Material Density	0.008027	kg/cm^3
P Number Thickness	0	mm
Yield Stress, Operating	146.59	MPa
External Pressure Chart Name	HA-2	
UNS Number	S31600	
Class / Thickness / Grade	:: > 5	
Product Form	Forgings	
Perform Flange Stress Calculation (Y/N)	Y	
Weld is pre-Heated	No	

Element From Node	50	
Element To Node	60	
Element Type	Cylinder	
Description	! Atype Main Shell	
Distance "FROM" to "TO"	753.8	mm
Element Outside Diameter	141.3	mm
Element Thickness	3.4	mm
Internal Corrosion Allowance	0	mm
Nominal Thickness	0	mm
External Corrosion Allowance	0	mm
Design Internal Pressure	2.5	MPa
Design Temperature Internal Pressure	210	°C
Design External Pressure	0.1013	MPa
Design Temperature External Pressure	210	°C
Effective Diameter Multiplier	1.0	
Material Name	SA-312 TP316	
Allowable Stress, Ambient	137.9	MPa
Allowable Stress, Operating	132.2	MPa
Allowable Stress, Hydrotest	179.3	MPa
Material Density	0.008027	kg/cm^3
P Number Thickness	0	mm
Yield Stress, Operating	146.6	MPa
External Pressure Chart Name	HA-2	
UNS Number	S31600	
Product Form	Smls. & wld. pipe	
Efficiency, Longitudinal Seam	1.0	
Efficiency, Circumferential Seam	1.0	
Weld is pre-Heated	No	

Element From Node	50
Detail Type	Nozzle

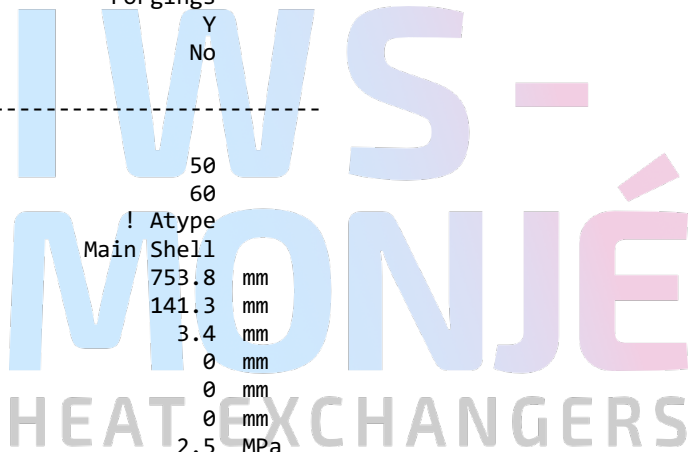

Strength Calculation PV-Elite

IWS-Monje Heat Exchangers GmbH

Wittener Str. 102, 44789 Bochum, Germany

PV Elite 24 Licensee: IWS-Monje? Heat Exchangers GmbH

FileName : BK12-3102-L800_Airpack-17811_Rev00 -----

Input Echo: Step: 1 11:11am May 5,2022

Detail ID	Noz N3 - Shell i
Dist. from "FROM" Node / Offset dist	72 mm
Nozzle Diameter	60.3 mm
Nozzle Schedule	40
Nozzle Class	300
Layout Angle	270.0
Blind Flange (Y/N)	N
Weight of Nozzle (Used if > 0)	0 N
Grade of Attached Flange	GR 2.2
Nozzle Matl	SA-312 TP316

Element From Node	50
Detail Type	Nozzle
Detail ID	Noz N4 - Shell o
Dist. from "FROM" Node / Offset dist	692 mm
Nozzle Diameter	60.3 mm
Nozzle Schedule	40
Nozzle Class	300
Layout Angle	90.0
Blind Flange (Y/N)	N
Weight of Nozzle (Used if > 0)	0 N
Grade of Attached Flange	GR 2.2
Nozzle Matl	SA-312 TP316

Element From Node	60
Element To Node	70
Element Type	Flange
Description	Shell flange ring 2
Distance "FROM" to "TO"	36 mm
Flange Inside Diameter	133 mm
Element Thickness	18 mm
Internal Corrosion Allowance	0 mm
Nominal Thickness	0 mm
External Corrosion Allowance	0 mm
Design Internal Pressure	1 MPa
Design Temperature Internal Pressure	210 °C
Design External Pressure	0.1013 MPa
Design Temperature External Pressure	210 °C
Effective Diameter Multiplier	1.0
Material Name	SA-182 F316
Allowable Stress, Ambient	137.9 MPa
Allowable Stress, Operating	131.6 MPa
Allowable Stress, Hydrotest	179.3 MPa
Material Density	0.008027 kg/cm^3
P Number Thickness	0 mm
Yield Stress, Operating	146.6 MPa
External Pressure Chart Name	HA-2
UNS Number	S31600
Class / Thickness / Grade	:: > 5
Product Form	Forgings
Perform Flange Stress Calculation (Y/N)	Y
Weld is pre-Heated	No

Strength Calculation PV-Elite
 IWS-Monje Heat Exchangers GmbH
 Wittener Str. 102, 44789 Bochum, Germany
 PV Elite 24 Licensee: IWS-Monje? Heat Exchangers GmbH
 FileName : BK12-3102-L800_Airpack-17811_Rev00 -----
 Input Echo: Step: 1 11:11am May 5,2022

Element From Node	70
Element To Node	80
Element Type	Flange
Description	Cover head
Distance "FROM" to "TO"	25 mm
Flange Outside Diameter	220 mm
Element Thickness	25 mm
Internal Corrosion Allowance	1 mm
Nominal Thickness	0 mm
External Corrosion Allowance	0 mm
Design Internal Pressure	1 MPa
Design Temperature Internal Pressure	95 °C
Design External Pressure	0.1013 MPa
Design Temperature External Pressure	95 °C
Effective Diameter Multiplier	1.0
Material Name	SA-516 70
Allowable Stress, Ambient	137.9 MPa
Allowable Stress, Operating	137.9 MPa
Allowable Stress, Hydrotest	179.3 MPa
Material Density	0.00775 kg/cm ³
P Number Thickness	30.988 mm
Yield Stress, Operating	239.7 MPa
UCS-66 Chart Curve Designation	B
External Pressure Chart Name	CS-2
UNS Number	K02700
Product Form	Plate
Perform Flange Stress Calculation (Y/N)	Y
Weld is pre-Heated	No

PV Elite is a trademark of Hexagon AB, 2022, All rights reserved.

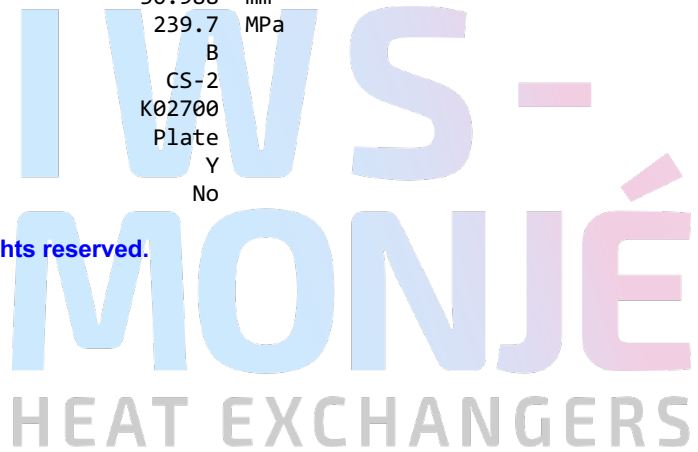
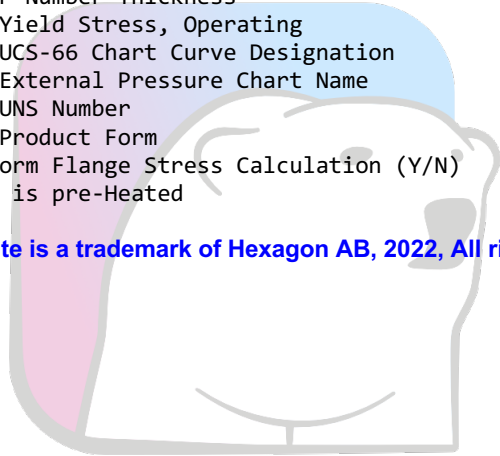

Strength Calculation PV-Elite
 IWS-Monje Heat Exchangers GmbH
 Wittener Str. 102, 44789 Bochum, Germany
 PV Elite 24 Licensee: IWS-Monje? Heat Exchangers GmbH
 FileName : BK12-3102-L800_Airpack-17811_Rev00 -----
 XY Coordinate Calculations: Step: 2 11:11am May 5,2022

XY Coordinate Calculations:

From	To	X (Horiz.) mm	Y (Vert.) mm	DX (Horiz.) mm	DY (Vert.) mm
Channel head fl		27	...	27	...
Channel head cy		57	...	30	...
Channel head fl		57	...	-18	...
Shell flange ri		134.525	...	36	...
Main Shell		888.325	...	753.8	...
Shell flange ri		924.325	...	36	...
Cover head		962.85	...	25	...

PV Elite includes an 1/8 inch (3.175mm) raised face and gasket thicknesses for girth flanges and tubesheet thicknesses where applicable in the Tangent to Tangent length calculation. The calculated dimensions are based on the given element lengths. Due to variability in manufacturing (weld gaps etc.), the Tangent to Tangent length may not be exact.

PV Elite is a trademark of Hexagon AB, 2022, All rights reserved.



Strength Calculation PV-Elite
 IWS-Monje Heat Exchangers GmbH
 Wittener Str. 102, 44789 Bochum, Germany
 PV Elite 24 Licensee: IWS-Monje? Heat Exchangers GmbH
 FileName : BK12-3102-L800_Airpack-17811_Rev00 -----
 Flg Calc [Int P]: Channel Fla. Flng: 37 11:11am May 5,2022

Flange Input Data Values**Description: Channel Fla. :**

Channel head flange

Flange Type		Integral Ring	
Design Pressure	P	1.00	MPa
Design Temperature		95	°C
Internal Corrosion Allowance	ci	1.0000	mm
External Corrosion Allowance	ce	0.0000	mm
Use Corrosion Allowance in Thickness Calcs.		Yes	
Attached Shell Inside Diameter	B	132.6000	mm
Integral Ring Inside Diameter		158.6000	mm
Flange Outside Diameter	A	220.000	mm
Flange Thickness	t	18.0000	mm
Flange Material		SA-516 70	
Flange Material UNS number		K02700	
Flange Allowable Stress At Temperature	Sfo	137.90	MPa
Flange Allowable Stress At Ambient	Sfa	137.90	MPa
Bolt Material		SA-193 B7	
Bolt Allowable Stress At Temperature	Sb	172.38	MPa
Bolt Allowable Stress At Ambient	Sa	172.38	MPa
Length of Weld Leg at Back of Ring	tw	0.0000	mm
Diameter of Bolt Circle	C	179.600	mm
Nominal Bolt Diameter	a	12.0000	mm
Type of Threads		TEMA Thread Series	
Number of Bolts		4	
Flange Face Outside Diameter	Fod	165.000	mm
Flange Face Inside Diameter	Fid	155.000	mm
Flange Facing Sketch		1, Code Sketch 1a	
Gasket Outside Diameter	Go	165.000	mm
Gasket Inside Diameter	Gi	155.000	mm
Gasket Factor	m	0.0000	
Gasket Design Seating Stress	y	0.00	MPa
Column for Gasket Seating		2, Code Column II	
Gasket Thickness	tg	2.0000	mm

Strength Calculation PV-Elite
 IWS-Monje Heat Exchangers GmbH
 Wittener Str. 102, 44789 Bochum, Germany
 PV Elite 24 Licensee: IWS-Monje Heat Exchangers GmbH
 FileName : BK12-3102-L800_Airpack-17811_Rev00 -----
 Flg Calc [Int P]: Channel Fla. Flng: 37 11:11am May 5,2022

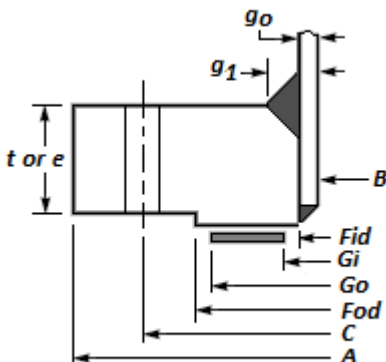

ASME Code, Section VIII Division 1, 2021

Corroded Flange Thickness, $t_c = T - c_i$	17.000 mm
Corroded Flange ID, $B_{cor} = B + 2 * F_{cor}$	134.600 mm
Corroded Large Hub, $g1_{cor} = g1 - c_i$	0.000 mm
Corroded Small Hub, $g0_{cor} = g0 - c_i$	0.000 mm
Code R Dimension, $R = ((C - B_{cor}) / 2) - g1_{cor}$	22.500 mm
Gasket Contact Width, $N = (G_o - G_i) / 2$	5.000 mm
Basic Gasket Width, $b_o = N / 2$	2.500 mm
Effective Gasket Width, $b = b_o$	2.500 mm
Gasket Reaction Diameter, $G = G_o$ (Self-Energizing)	165.000 mm

Basic Flange and Bolt Loads:

Hydrostatic End Load due to Pressure [H]:
 $= 0.785 * G^2 * P_{eq}$
 $= 0.785 * 165.0^2 * 1.$
 $= 21380.648 \text{ N}$

Contact Load on Gasket Surfaces [Hp]:
 $= 2 * b * \pi * G * m * P$
 $= 2 * 2.5 * \pi * 165.0 * 0.0 * 1.$
 $= 0.000 \text{ N}$

Hydrostatic End Load at Flange ID [Hd]:
 $= \pi * B_{cor}^2 * P / 4$
 $= \pi * 134.6^2 * 1. / 4$
 $= 14227.976 \text{ N}$

Pressure Force on Flange Face [Ht]:
 $= H - H_d$
 $= 21381 - 14228$
 $= 7152.672 \text{ N}$

Operating Bolt Load [Wm1]:
 $= \max(H + H_p + H'p, 0)$
 $= \max(21381 + 0 + 0, 0)$
 $= 21380.648 \text{ N}$

Strength Calculation PV-Elite
 IWS-Monje Heat Exchangers GmbH
 Wittener Str. 102, 44789 Bochum, Germany
 PV Elite 24 Licensee: IWS-Monje? Heat Exchangers GmbH
 FileName : BK12-3102-L800_Airpack-17811_Rev00 -----
 Flg Calc [Int P]: Channel Fla. Flng: 37 11:11am May 5,2022

Gasket Seating Bolt Load [Wm2]:
 $= y * b * pi * G + yPart * bPart * lp$
 $= 0.0 * 2.5 * pi * 165.0 + 0.0 * 0.0 * 0.0$
 $= 0.000 \text{ N}$

Required Bolt Area [Am]:
 $= \max(Wm1/Sb, Wm2/Sa)$
 $= \max(21381/172, 0/172)$
 $= 124.046 \text{ mm}^2$

ASME Maximum Circumferential Spacing between Bolts per App. 2 eq. (3) [Bsmax]:
 $= 2a + 6t / (m + 0.5)$
 $= 2 * 12.7 + 6 * 17.0 / (0.0 + 0.5)$
 $= 229.400 \text{ mm}$

Actual Circumferential Bolt Spacing [Bs]:
 $= C * \sin(pi / n)$
 $= 179.6 * \sin(pi/4)$
 $= 126.996 \text{ mm}$

ASME Moment Multiplier for Bolt Spacing per App. 2 eq. (7) [Bsc]:
 $= \max(\text{sqrt}(Bs / (2a + t)), 1)$
 $= \max(\text{sqrt}(126.996 / (2 * 12.7 + 17.0)), 1)$
 $= 1.7307$

Bolting Information for TEMA Imperial Thread Series (Non Mandatory):

Distance Across Corners for Nuts		24.613	mm	
Circular Wrench End Diameter	a	38.100	mm	
		Minimum	Actual	Maximum
Bolt Area:		124.046	325.161	
Radial Distance between Hub and Bolts:		15.875	23.500	
Radial Distance between Bolts and Edge:		15.875	20.200	
Circ. Spacing between the Bolts:		31.750	126.996	229.400

Flange Design Bolt Load, Gasket Seating [W]:
 $= Sa(Am + Ab) / 2$
 $= 172.38(124.0462 + 325.1606) / 2$
 $= 38712.72 \text{ N}$

Gasket Load for the Operating Condition [HG]:
 $= Wm1 - H$
 $= 21381 - 21381$
 $= 0.00 \text{ N}$

Moment Arm Calculations:

Distance to Gasket Load Reaction [hg]:
 $= (C - G) / 2$
 $= (179.6 - 165.0) / 2$
 $= 7.3000 \text{ mm}$

Distance to Face Pressure Reaction [ht]:
 $= (R + g1 + hg) / 2$

Strength Calculation PV-Elite
 IWS-Monje Heat Exchangers GmbH
 Wittener Str. 102, 44789 Bochum, Germany
 PV Elite 24 Licensee: IWS-Monj? Heat Exchangers GmbH
 FileName : BK12-3102-L800_Airpack-17811_Rev00 -----
 Flg Calc [Int P]: Channel Fla. Flng: 37 11:11am May 5,2022

$$= (22.5 + 0.0 + 7.3)/2$$

$$= 14.9000 \text{ mm}$$

Distance to End Pressure Reaction [hd]:

$$= R + (g1 / 2)$$

$$= 22.5 +(0.0/2.0)$$

$$= 22.5000 \text{ mm}$$

Summary of Moments for Internal Pressure: (N-mm)

Loading	Force	Distance	Bolt Corr	Moment
End Pressure, Md	14228.	22.5000	1.7307	554261.
Face Pressure, Mt	7153.	14.9000	1.7307	184520.
Gasket Load, Mg	0.	7.3000	1.7307	0.
Gasket Seating, Matm	38713.	7.3000	1.7307	489289.

Total Moment for Operation, Mop 738781. N-mm
 Total Moment for Gasket seating, Matm 489289. N-mm

Effective Hub Length, ho = sqrt(Bcor*goCor) 0.000 mm
 Hub Ratio, h/h0 = Defined as 0 0.000
 Thickness Ratio, g1/g0 = Defined as 0.0 0.000
 Factors from Figure 2-7.1
 K = 1.634
 U = 4.535
 Z = 2.197
 T = 1.653
 Y = 4.126

Tangential Flange Stress, Operating [Sto]:
 = (Y * Mop)/(t² * Bcor)
 = (4.1264*738781)/(17.0²*134.6)
 = 78.34 MPa

Tangential Flange Stress, Seating [STa]:
 = (Y * Matm)/(t² * Bcor)
 = (4.1264*489289)/(17.0²*134.6)
 = 51.89 MPa

Bolt Stress, Operating [BSo]:
 = Wm1 / Ab
 = 21381/325.1606
 = 65.76 MPa

Bolt Stress, Seating [BSa]:
 = (Wm2 / Ab)
 = (0/325.1606)
 = 0.00 MPa

Flange Stress Analysis Results: MPa

	Actual	Operating Allowed	Gasket Seating Actual	Gasket Seating Allowed
Tangential Flange	78.34	137.90	51.89	137.90
Bolting	65.76	172.38	0.00	172.38

Minimum Required Flange Thickness 14.249 mm
 Estimated M.A.W.P. (Operating) 2 MPa

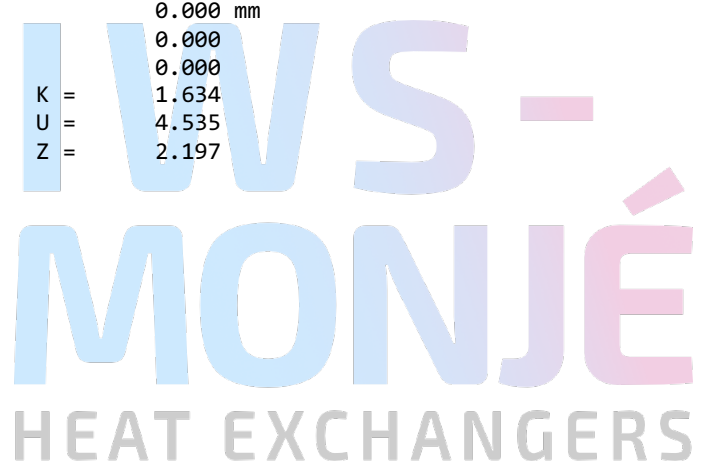

Strength Calculation PV-Elite
IWS-Monje Heat Exchangers GmbH
Wittener Str. 102, 44789 Bochum, Germany
PV Elite 24 Licensee: IWS-Monje Heat Exchangers GmbH
FileName : BK12-3102-L800_Airpack-17811_Rev00 -----
Flg Calc [Int P]: Channel Fla. Flng: 37 11:11am May 5,2022

Estimated Finished Weight of Flange at given Thk. 3.4 kg
Estimated Unfinished Weight of Forging at given Thk 3.4 kg

Required Fillet Weld Leg size for Slip on Flanges:

= max(tn, (6 mm or 1/4 inch)) no hub size given
= max(12.0, 6.0)
= 12.000 mm

PV Elite is a trademark of Hexagon AB, 2022, All rights reserved.

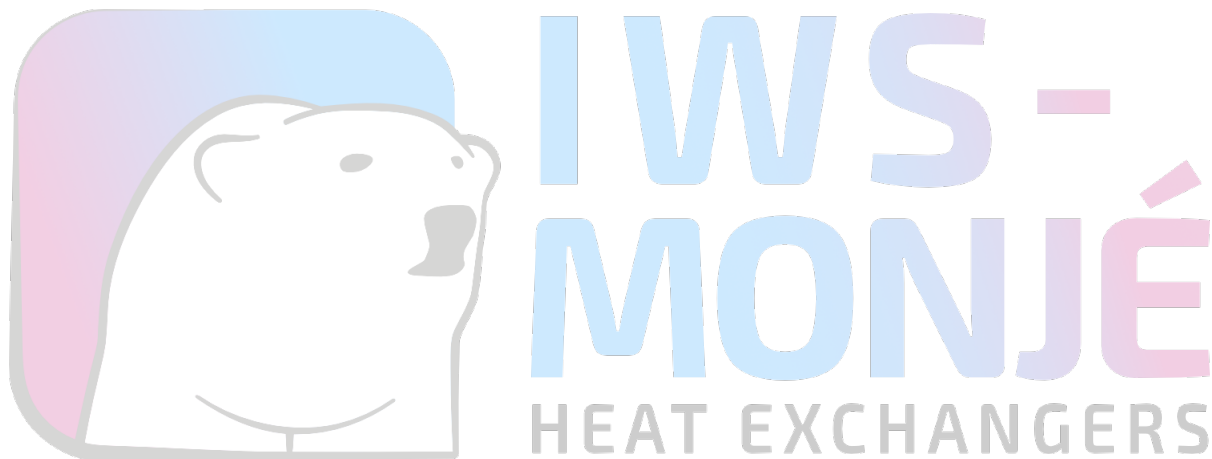

Strength Calculation PV-Elite
 IWS-Monje Heat Exchangers GmbH
 Wittener Str. 102, 44789 Bochum, Germany
 PV Elite 24 Licensee: IWS-Monj? Heat Exchangers GmbH
 FileName : BK12-3102-L800_Airpack-17811_Rev00 -----
 Flg Calc [Int P]: Shell Fl. 1 Flng: 38 11:11am May 5,2022

Flange Input Data Values

Description: Shell Fl. 1 :

Shell flange ring 1

Flange Type	Integral Weld Neck		
Design Pressure	P	1.00	MPa
Design Temperature		210	°C
Internal Corrosion Allowance	ci	0.0000	mm
External Corrosion Allowance	ce	0.0000	mm
Use Corrosion Allowance in Thickness Calcs.		Yes	
Flange Inside Diameter	B	133.000	mm
Flange Outside Diameter	A	220.000	mm
Flange Thickness	t	18.0000	mm
Thickness of Hub at Small End	go	3.4000	mm
Thickness of Hub at Large End	g1	4.5000	mm
Length of Hub	h	18.0000	mm
Flange Material		SA-182 F316	
Flange Material UNS number		S31600	
Flange Allowable Stress At Temperature	Sfo	131.56	MPa
Flange Allowable Stress At Ambient	Sfa	137.90	MPa
Bolt Material		SA-193 B7	
Bolt Allowable Stress At Temperature	Sb	172.38	MPa
Bolt Allowable Stress At Ambient	Sa	172.38	MPa
Diameter of Bolt Circle	C	179.600	mm
Nominal Bolt Diameter	a	12.0000	mm
Type of Threads		TEMA Thread Series	
Number of Bolts		4	
Flange Face Outside Diameter	Fod	165.000	mm
Flange Face Inside Diameter	Fid	155.000	mm
Flange Facing Sketch		1, Code Sketch 1a	
Gasket Outside Diameter	Go	165.000	mm
Gasket Inside Diameter	Gi	155.000	mm
Gasket Factor	m	0.0000	
Gasket Design Seating Stress	y	0.00	MPa
Column for Gasket Seating		2, Code Column II	
Gasket Thickness	tg	2.0000	mm

Strength Calculation PV-Elite
 IWS-Monje Heat Exchangers GmbH
 Wittener Str. 102, 44789 Bochum, Germany
 PV Elite 24 Licensee: IWS-Monje Heat Exchangers GmbH
 FileName : BK12-3102-L800_Airpack-17811_Rev00 -----
 Flg Calc [Int P]: Shell Fl. 1 Flng: 38 11:11am May 5,2022

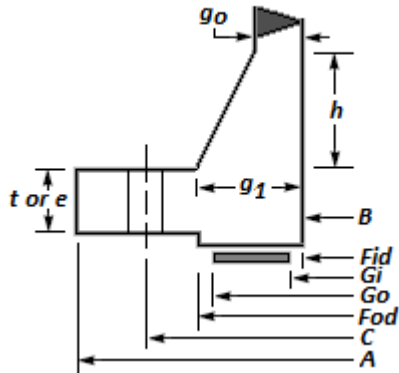

ASME Code, Section VIII Division 1, 2021

Hub Small End Required Thickness due to Internal Pressure:

$$\begin{aligned}
 &= (P \cdot (D/2 + Ca)) / (S \cdot E - 0.6 \cdot P) \text{ per UG-27 (c)(1)} \\
 &= (1. \cdot (133.0/2 + 0.0)) / (131.56 \cdot 1.0 - 0.6 \cdot 1.) + Ca \\
 &= 0.5078 \text{ mm}
 \end{aligned}$$

Hub Small End Hub MAWP:

$$\begin{aligned}
 &= (S \cdot E \cdot t) / (R + 0.6 \cdot t) \text{ per UG-27 (c)(1)} \\
 &= (131.56 \cdot 1.0 \cdot 3.4) / (66.5 + 0.6 \cdot 3.4) \\
 &= 6.526 \text{ MPa}
 \end{aligned}$$

Corroded Flange ID,	Bcor = B + 2 * Fcor	133.000 mm
Corroded Large Hub,	g1Cor = g1 - ci	4.500 mm
Corroded Small Hub,	g0Cor = go - ci	3.400 mm
Code R Dimension,	R = (C - B) / 2 - g1	18.800 mm
Gasket Contact Width,	N = (Go - Gi) / 2	5.000 mm
Basic Gasket Width,	bo = N / 2	2.500 mm
Effective Gasket Width,	b = bo	2.500 mm
Gasket Reaction Diameter,	G = Go (Self-Energizing)	165.000 mm

Basic Flange and Bolt Loads:

Hydrostatic End Load due to Pressure [H]:

$$\begin{aligned}
 &= 0.785 \cdot G^2 \cdot Peq \\
 &= 0.785 \cdot 165.0^2 \cdot 1. \\
 &= 21380.648 \text{ N}
 \end{aligned}$$

Contact Load on Gasket Surfaces [Hp]:

$$\begin{aligned}
 &= 2 \cdot b \cdot \pi \cdot G \cdot m \cdot P \\
 &= 2 \cdot 2.5 \cdot \pi \cdot 165.0 \cdot 0.0 \cdot 1. \\
 &= 0.000 \text{ N}
 \end{aligned}$$

Hydrostatic End Load at Flange ID [Hd]:

$$\begin{aligned}
 &= \pi \cdot Bcor^2 \cdot P / 4 \\
 &= \pi \cdot 133.0^2 \cdot 1. / 4 \\
 &= 13891.725 \text{ N}
 \end{aligned}$$

Strength Calculation PV-Elite
IWS-Monje Heat Exchangers GmbH
Wittener Str. 102, 44789 Bochum, Germany
PV Elite 24 Licensee: IWS-Monje Heat Exchangers GmbH
FileName : BK12-3102-L800_Airpack-17811_Rev00 -----
Flg Calc [Int P]: Shell Fl. 1 Flng: 38 11:11am May 5,2022

Pressure Force on Flange Face [Ht]:

$$\begin{aligned}
 &= H - H_d \\
 &= 21381 - 13892 \\
 &= 7488.922 \text{ N}
 \end{aligned}$$

Operating Bolt Load [Wm1]:

$$\begin{aligned}
 &= \max(H + H_p + H'p, 0) \\
 &= \max(21381 + 0 + 0, 0) \\
 &= 21380.648 \text{ N}
 \end{aligned}$$

Gasket Seating Bolt Load [Wm2]:

$$\begin{aligned}
 &= y * b * \pi * G + y_{Part} * b_{Part} * l_p \\
 &= 0.0 * 2.5 * \pi * 165.0 + 0.0 * 0.0 * 0.0 \\
 &= 0.000 \text{ N}
 \end{aligned}$$

Required Bolt Area [Am]:

$$\begin{aligned}
 &= \max(Wm1/S_b, Wm2/S_a) \\
 &= \max(21381/172, 0/172) \\
 &= 124.046 \text{ mm}^2
 \end{aligned}$$

ASME Maximum Circumferential Spacing between Bolts per App. 2 eq. (3) [Bsmax]:

$$\begin{aligned}
 &= 2a + 6t / (m + 0.5) \\
 &= 2 * 12.7 + 6 * 18.0 / (0.0 + 0.5) \\
 &= 241.400 \text{ mm}
 \end{aligned}$$

Actual Circumferential Bolt Spacing [Bs]:

$$\begin{aligned}
 &= C * \sin(\pi / n) \\
 &= 179.6 * \sin(\pi / 4) \\
 &= 126.996 \text{ mm}
 \end{aligned}$$

ASME Moment Multiplier for Bolt Spacing per App. 2 eq. (7) [Bsc]:

$$\begin{aligned}
 &= \max(\sqrt{ Bs / (2a + t) }, 1) \\
 &= \max(\sqrt{ 126.996 / (2 * 12.7 + 18.0) }, 1) \\
 &= 1.7106
 \end{aligned}$$

Bolting Information for TEMA Imperial Thread Series (Non Mandatory):

	Minimum	Actual	Maximum
Bolt Area:	124.046	325.161	
Radial Distance between Hub and Bolts:	20.637	18.800	
Radial Distance between Bolts and Edge:	15.875	20.200	
Circ. Spacing between the Bolts:	31.750	126.996	241.400

Flange Design Bolt Load, Gasket Seating [W]:

$$\begin{aligned}
 &= S_a (A_m + A_b) / 2 \\
 &= 172.38 (124.0462 + 325.1606) / 2 \\
 &= 38712.72 \text{ N}
 \end{aligned}$$

Gasket Load for the Operating Condition [HG]:

$$\begin{aligned}
 &= Wm1 - H \\
 &= 21381 - 21381 \\
 &= 0.00 \text{ N}
 \end{aligned}$$

Moment Arm Calculations:

Strength Calculation PV-Elite
 IWS-Monje Heat Exchangers GmbH
 Wittener Str. 102, 44789 Bochum, Germany
 PV Elite 24 Licensee: IWS-Monje? Heat Exchangers GmbH
 FileName : BK12-3102-L800_Airpack-17811_Rev00 -----
 Flg Calc [Int P]: Shell Fl. 1 Flng: 38 11:11am May 5,2022

Distance to Gasket Load Reaction [hg]:

$$= (C - G) / 2$$

$$= (179.6 - 165.0) / 2$$

$$= 7.3000 \text{ mm}$$

Distance to Face Pressure Reaction [ht]:

$$= (R + g1 + hg) / 2$$

$$= (18.8 + 4.5 + 7.3) / 2$$

$$= 15.3000 \text{ mm}$$

Distance to End Pressure Reaction [hd]:

$$= R + (g1 / 2)$$

$$= 18.8 + (4.5 / 2)$$

$$= 21.0500 \text{ mm}$$

Summary of Moments for Internal Pressure: (N-mm)

Loading	Force	Distance	Bolt Corr	Moment
End Pressure, Md	13892.	21.0500	1.7106	500421.
Face Pressure, Mt	7489.	15.3000	1.7106	196082.
Gasket Load, Mg	0.	7.3000	1.7106	0.
Gasket Seating, Matm	38713.	7.3000	1.7106	483619.
Total Moment for Operation, Mop				696503. N-mm
Total Moment for Gasket seating, Matm				483619. N-mm
Effective Hub Length, ho = sqrt(Bcor*goCor)			21.265 mm	
Hub Ratio, h/h0 = HL / H0			0.846	
Thickness Ratio, g1/g0 = (g1Cor/goCor)			1.324	
Flange Factors for Integral Flange:				
Factor F			0.835	
Factor V			0.330	
Factor f			1.000	
Factors from Figure 2-7.1				
T =	1.645		K =	1.654
Y =	4.032		U =	4.431
e =	0.0393 1/mm		Z =	2.152
			d =	3305.564 mm ³
Stress Factors				
Beta =	1.942		Alpha =	1.707
Delta =	1.764		Gamma =	1.038
			Lambda =	2.802

Longitudinal Hub Stress, Operating [SHo]:

$$= (f * Mop / Bcor) / (L * g1^2)$$

$$= (1.0 * 696503 / 133.0) / (2.8021 * 4.5^2)$$

$$= 92.26 \text{ MPa}$$

Longitudinal Hub Stress, Seating [SHa]:

$$= (f * Matm / Bcor) / (L * g1^2)$$

$$= (1.0 * 483619 / 133.0) / (2.8021 * 4.5^2)$$

$$= 64.06 \text{ MPa}$$

Radial Flange Stress, Operating [SRo]:

$$= (beta * Mop / Bcor) / (L * t^2)$$

$$= (1.9424 * 696503 / 133.0) / (2.8021 * 18.0^2)$$

$$= 11.20 \text{ MPa}$$

Strength Calculation PV-Elite
 IWS-Monje Heat Exchangers GmbH
 Wittener Str. 102, 44789 Bochum, Germany
 PV Elite 24 Licensee: IWS-Monje? Heat Exchangers GmbH
 FileName : BK12-3102-L800_Airpack-17811_Rev00 -----
 Flg Calc [Int P]: Shell Fl. 1 Flng: 38 11:11am May 5,2022

Radial Flange Stress, Seating [SRa]:

$$= (\text{beta} * \text{Matm}/\text{Bcor}) / (\text{L} * \text{t}^2)$$

$$= (1.9424*483619/133.0) / (2.8021*18.0^2)$$

$$= 7.78 \text{ MPa}$$

Tangential Flange Stress, Operating [STo]:

$$= (\text{Y} * \text{Mo} / (\text{t}^2 * \text{Bcor})) - \text{Z} * \text{SRo}$$

$$= (4.0324*696503 / (18.0^2 * 133.0)) - 2.152 * 11$$

$$= 41.05 \text{ MPa}$$

Tangential Flange Stress, Seating [STa]:

$$= (\text{y} * \text{Matm} / (\text{t}^2 * \text{Bcor})) - \text{Z} * \text{SRa}$$

$$= (4.0324*483619 / (18.0^2 * 133.0)) - 2.152 * 8$$

$$= 28.50 \text{ MPa}$$

Average Flange Stress, Operating [SAo]:

$$= (\text{SHo} + \max(\text{SRo}, \text{STo})) / 2$$

$$= (92 + \max(11, 41)) / 2$$

$$= 66.66 \text{ MPa}$$

Average Flange Stress, Seating [SAa]:

$$= (\text{SHa} + \max(\text{SRa}, \text{STa})) / 2$$

$$= (64 + \max(8, 29)) / 2$$

$$= 46.28 \text{ MPa}$$

Bolt Stress, Operating [BSo]:

$$= \text{Wm1} / \text{Ab}$$

$$= 21381 / 325.1606$$

$$= 65.76 \text{ MPa}$$

Bolt Stress, Seating [BSa]:

$$= (\text{Wm2} / \text{Ab})$$

$$= (0 / 325.1606)$$

$$= 0.00 \text{ MPa}$$

Flange Stress Analysis Results: MPa

	Operating		Gasket Seating	
	Actual	Allowed	Actual	Allowed
Longitudinal Hub	92.26	197.34	64.06	206.85
Radial Flange	11.20	131.56	7.78	137.90
Tangential Flange	41.05	131.56	28.50	137.90
Maximum Average	66.66	131.56	46.28	137.90
Bolting	65.76	172.38	0.00	172.38

Minimum Required Flange Thickness	12.141 mm
Estimated M.A.W.P. (Operating)	2 MPa
Estimated Finished Weight of Flange at given Thk.	3.7 kg
Estimated Unfinished Weight of Forging at given Thk	7.0 kg

SA-182 F316, Min Metal Temp without impact per UHA-51: -196 °C

PV Elite is a trademark of Hexagon AB, 2022, All rights reserved.

Strength Calculation PV-Elite
 IWS-Monje Heat Exchangers GmbH
 Wittener Str. 102, 44789 Bochum, Germany
 PV Elite 24 Licensee: IWS-Monj? Heat Exchangers GmbH
 FileName : BK12-3102-L800_Airpack-17811_Rev00 -----
 Flg Calc [Int P]: Shell Fl. 2 Flng: 39 11:11am May 5,2022

Flange Input Data Values

Description: Shell Fl. 2 :

Shell flange ring 2

Flange Type	Integral Weld Neck		
Design Pressure	P	1.00	MPa
Design Temperature		210	°C
Internal Corrosion Allowance	ci	0.0000	mm
External Corrosion Allowance	ce	0.0000	mm
Use Corrosion Allowance in Thickness Calcs.		Yes	
Flange Inside Diameter	B	133.000	mm
Flange Outside Diameter	A	220.000	mm
Flange Thickness	t	18.0000	mm
Thickness of Hub at Small End	go	3.4000	mm
Thickness of Hub at Large End	g1	4.5000	mm
Length of Hub	h	18.0000	mm
Flange Material		SA-182 F316	
Flange Material UNS number		S31600	
Flange Allowable Stress At Temperature	Sfo	131.60	MPa
Flange Allowable Stress At Ambient	Sfa	137.90	MPa
Bolt Material		SA-193 B7	
Bolt Allowable Stress At Temperature	Sb	172.38	MPa
Bolt Allowable Stress At Ambient	Sa	172.38	MPa
Diameter of Bolt Circle	C	179.600	mm
Nominal Bolt Diameter	a	12.0000	mm
Type of Threads		TEMA Thread Series	
Number of Bolts		4	
Flange Face Outside Diameter	Fod	165.000	mm
Flange Face Inside Diameter	Fid	155.000	mm
Flange Facing Sketch		1, Code Sketch 1a	
Gasket Outside Diameter	Go	165.000	mm
Gasket Inside Diameter	Gi	155.000	mm
Gasket Factor	m	0.0000	
Gasket Design Seating Stress	y	0.00	MPa
Column for Gasket Seating		2, Code Column II	
Gasket Thickness	tg	2.0000	mm

Strength Calculation PV-Elite
 IWS-Monje Heat Exchangers GmbH
 Wittener Str. 102, 44789 Bochum, Germany
 PV Elite 24 Licensee: IWS-Monje Heat Exchangers GmbH
 FileName : BK12-3102-L800_Airpack-17811_Rev00 -----
 Flg Calc [Int P]: Shell Fl. 2 Flng: 39 11:11am May 5,2022

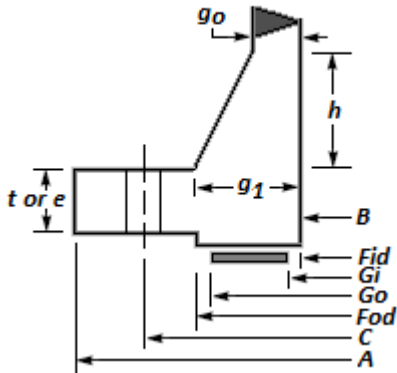

ASME Code, Section VIII Division 1, 2021

Hub Small End Required Thickness due to Internal Pressure:

$$\begin{aligned}
 &= (P \cdot (D/2 + Ca)) / (S \cdot E - 0.6 \cdot P) \text{ per UG-27 (c)(1)} \\
 &= (1. \cdot (133.0 / 2 + 0.0)) / (131.6 \cdot 1.0 - 0.6 \cdot 1.) + Ca \\
 &= 0.5076 \text{ mm}
 \end{aligned}$$

Hub Small End Hub MAWP:

$$\begin{aligned}
 &= (S \cdot E \cdot t) / (R + 0.6 \cdot t) \text{ per UG-27 (c)(1)} \\
 &= (131.6 \cdot 1.0 \cdot 3.4) / (66.5 + 0.6 \cdot 3.4) \\
 &= 6.528 \text{ MPa}
 \end{aligned}$$

Corroded Flange ID,	Bcor = B + 2 * Fcor	133.000 mm
Corroded Large Hub,	g1Cor = g1 - ci	4.500 mm
Corroded Small Hub,	g0Cor = go - ci	3.400 mm
Code R Dimension,	R = (C - B) / 2 - g1	18.800 mm
Gasket Contact Width,	N = (Go - Gi) / 2	5.000 mm
Basic Gasket Width,	bo = N / 2	2.500 mm
Effective Gasket Width,	b = bo	2.500 mm
Gasket Reaction Diameter,	G = Go (Self-Energizing)	165.000 mm

Basic Flange and Bolt Loads:

Hydrostatic End Load due to Pressure [H]:

$$\begin{aligned}
 &= 0.785 \cdot G^2 \cdot Peq \\
 &= 0.785 \cdot 165.0^2 \cdot 1. \\
 &= 21380.648 \text{ N}
 \end{aligned}$$

Contact Load on Gasket Surfaces [Hp]:

$$\begin{aligned}
 &= 2 \cdot b \cdot \pi \cdot G \cdot m \cdot P \\
 &= 2 \cdot 2.5 \cdot \pi \cdot 165.0 \cdot 0.0 \cdot 1. \\
 &= 0.000 \text{ N}
 \end{aligned}$$

Hydrostatic End Load at Flange ID [Hd]:

$$\begin{aligned}
 &= \pi \cdot Bcor^2 \cdot P / 4 \\
 &= \pi \cdot 133.0^2 \cdot 1. / 4 \\
 &= 13891.725 \text{ N}
 \end{aligned}$$

Strength Calculation PV-Elite
 IWS-Monje Heat Exchangers GmbH
 Wittener Str. 102, 44789 Bochum, Germany
 PV Elite 24 Licensee: IWS-Monje Heat Exchangers GmbH
 FileName : BK12-3102-L800_Airpack-17811_Rev00 -----
 Flg Calc [Int P]: Shell Fl. 2 Flng: 39 11:11am May 5,2022

Pressure Force on Flange Face [Ht]:

$$= H - Hd$$

$$= 21381 - 13892$$

$$= 7488.922 \text{ N}$$

Operating Bolt Load [Wm1]:

$$= \max(H + Hp + H'p, 0)$$

$$= \max(21381 + 0 + 0, 0)$$

$$= 21380.648 \text{ N}$$

Gasket Seating Bolt Load [Wm2]:

$$= y * b * pi * G + yPart * bPart * lp$$

$$= 0.0 * 2.5 * pi * 165.0 + 0.0 * 0.0 * 0.0$$

$$= 0.000 \text{ N}$$

Required Bolt Area [Am]:

$$= \max(Wm1/Sb, Wm2/Sa)$$

$$= \max(21381/172, 0/172)$$

$$= 124.046 \text{ mm}^2$$

ASME Maximum Circumferential Spacing between Bolts per App. 2 eq. (3) [Bsmax]:

$$= 2a + 6t / (m + 0.5)$$

$$= 2 * 12.7 + 6 * 18.0 / (0.0 + 0.5)$$

$$= 241.400 \text{ mm}$$

Actual Circumferential Bolt Spacing [Bs]:

$$= C * \sin(pi / n)$$

$$= 179.6 * \sin(pi / 4)$$

$$= 126.996 \text{ mm}$$

ASME Moment Multiplier for Bolt Spacing per App. 2 eq. (7) [Bsc]:

$$= \max(\sqrt{ Bs / (2a + t) }, 1)$$

$$= \max(\sqrt{ 126.996 / (2 * 12.7 + 18.0) }, 1)$$

$$= 1.7106$$

Bolting Information for TEMA Imperial Thread Series (Non Mandatory):

	Minimum	Actual	Maximum
Bolt Area:	124.046	325.161	
Radial Distance between Hub and Bolts:	20.637	18.800	
Radial Distance between Bolts and Edge:	15.875	20.200	
Circ. Spacing between the Bolts:	31.750	126.996	241.400

Flange Design Bolt Load, Gasket Seating [W]:

$$= Sa(Am + Ab) / 2$$

$$= 172.38(124.0462 + 325.1606) / 2$$

$$= 38712.72 \text{ N}$$

Gasket Load for the Operating Condition [HG]:

$$= Wm1 - H$$

$$= 21381 - 21381$$

$$= 0.00 \text{ N}$$

Moment Arm Calculations:

Strength Calculation PV-Elite
 IWS-Monje Heat Exchangers GmbH
 Wittener Str. 102, 44789 Bochum, Germany
 PV Elite 24 Licensee: IWS-Monje? Heat Exchangers GmbH
 FileName : BK12-3102-L800_Airpack-17811_Rev00 -----
 Flg Calc [Int P]: Shell Fl. 2 Flng: 39 11:11am May 5,2022

Distance to Gasket Load Reaction [hg]:

$$= (C - G) / 2$$

$$= (179.6 - 165.0) / 2$$

$$= 7.3000 \text{ mm}$$

Distance to Face Pressure Reaction [ht]:

$$= (R + g1 + hg) / 2$$

$$= (18.8 + 4.5 + 7.3) / 2$$

$$= 15.3000 \text{ mm}$$

Distance to End Pressure Reaction [hd]:

$$= R + (g1 / 2)$$

$$= 18.8 + (4.5 / 2.0)$$

$$= 21.0500 \text{ mm}$$

Summary of Moments for Internal Pressure: (N-mm)

Loading	Force	Distance	Bolt Corr	Moment
End Pressure, Md	13892.	21.0500	1.7106	500421.
Face Pressure, Mt	7489.	15.3000	1.7106	196082.
Gasket Load, Mg	0.	7.3000	1.7106	0.
Gasket Seating, Matm	38713.	7.3000	1.7106	483619.
Total Moment for Operation, Mop				696503. N-mm
Total Moment for Gasket seating, Matm				483619. N-mm
Effective Hub Length, ho = sqrt(Bcor*goCor)			21.265 mm	
Hub Ratio, h/h0 = HL / H0			0.846	
Thickness Ratio, g1/g0 = (g1Cor/goCor)			1.324	
Flange Factors for Integral Flange:				
Factor F			0.835	
Factor V			0.330	
Factor f			1.000	
Factors from Figure 2-7.1				
T =	1.645		K =	1.654
Y =	4.032		U =	4.431
e =	0.0393 1/mm		Z =	2.152
			d =	3305.564 mm ³
Stress Factors				
Beta =	1.942		Alpha =	1.707
Delta =	1.764		Gamma =	1.038
			Lambda =	2.802

Longitudinal Hub Stress, Operating [SHo]:

$$= (f * Mop / Bcor) / (L * g1^2)$$

$$= (1.0 * 696503 / 133.0) / (2.8021 * 4.5^2)$$

$$= 92.26 \text{ MPa}$$

Longitudinal Hub Stress, Seating [SHa]:

$$= (f * Matm / Bcor) / (L * g1^2)$$

$$= (1.0 * 483619 / 133.0) / (2.8021 * 4.5^2)$$

$$= 64.06 \text{ MPa}$$

Radial Flange Stress, Operating [SRo]:

$$= (beta * Mop / Bcor) / (L * t^2)$$

$$= (1.9424 * 696503 / 133.0) / (2.8021 * 18.0^2)$$

$$= 11.20 \text{ MPa}$$

Strength Calculation PV-Elite
 IWS-Monje Heat Exchangers GmbH
 Wittener Str. 102, 44789 Bochum, Germany
 PV Elite 24 Licensee: IWS-Monje? Heat Exchangers GmbH
 FileName : BK12-3102-L800_Airpack-17811_Rev00 -----
 Flg Calc [Int P]: Shell Fl. 2 Flng: 39 11:11am May 5,2022

Radial Flange Stress, Seating [SRa]:

$$= (\text{beta} * \text{Matm}/\text{Bcor}) / (\text{L} * \text{t}^2)$$

$$= (1.9424*483619/133.0) / (2.8021*18.0^2)$$

$$= 7.78 \text{ MPa}$$

Tangential Flange Stress, Operating [STo]:

$$= (\text{Y} * \text{Mo} / (\text{t}^2 * \text{Bcor})) - \text{Z} * \text{SRo}$$

$$= (4.0324*696503 / (18.0^2 * 133.0)) - 2.152 * 11$$

$$= 41.05 \text{ MPa}$$

Tangential Flange Stress, Seating [STa]:

$$= (\text{y} * \text{Matm} / (\text{t}^2 * \text{Bcor})) - \text{Z} * \text{SRa}$$

$$= (4.0324*483619 / (18.0^2 * 133.0)) - 2.152 * 8$$

$$= 28.50 \text{ MPa}$$

Average Flange Stress, Operating [SAo]:

$$= (\text{SHo} + \text{max}(\text{SRo}, \text{STo})) / 2$$

$$= (92 + \text{max}(11, 41)) / 2$$

$$= 66.66 \text{ MPa}$$

Average Flange Stress, Seating [SAa]:

$$= (\text{SHa} + \text{max}(\text{SRa}, \text{STa})) / 2$$

$$= (64 + \text{max}(8, 29)) / 2$$

$$= 46.28 \text{ MPa}$$

Bolt Stress, Operating [BSo]:

$$= \text{Wm1} / \text{Ab}$$

$$= 21381 / 325.1606$$

$$= 65.76 \text{ MPa}$$

Bolt Stress, Seating [BSa]:

$$= (\text{Wm2} / \text{Ab})$$

$$= (0 / 325.1606)$$

$$= 0.00 \text{ MPa}$$

Flange Stress Analysis Results: MPa

	Operating		Gasket Seating	
	Actual	Allowed	Actual	Allowed
Longitudinal Hub	92.26	197.40	64.06	206.85
Radial Flange	11.20	131.60	7.78	137.90
Tangential Flange	41.05	131.60	28.50	137.90
Maximum Average	66.66	131.60	46.28	137.90
Bolting	65.76	172.38	0.00	172.38

Minimum Required Flange Thickness	12.141 mm
Estimated M.A.W.P. (Operating)	2 MPa
Estimated Finished Weight of Flange at given Thk.	3.7 kg
Estimated Unfinished Weight of Forging at given Thk	7.0 kg

SA-182 F316, Min Metal Temp without impact per UHA-51: -196 °C

PV Elite is a trademark of Hexagon AB, 2022, All rights reserved.

Strength Calculation PV-Elite
 IWS-Monje Heat Exchangers GmbH
 Wittener Str. 102, 44789 Bochum, Germany
 PV Elite 24 Licensee: IWS-Monje? Heat Exchangers GmbH
 FileName : BK12-3102-L800_Airpack-17811_Rev00 -----
 Flg Calc [Int P]: Cover head Flng: 40 11:11am May 5,2022

Flange Input Data Values

Description: Cover head :

Cover head

Flange Type		Blind	
Design Pressure	P	1.00	MPa
Design Temperature		95	°C
Internal Corrosion Allowance	ci	1.0000	mm
External Corrosion Allowance	ce	0.0000	mm
Use Corrosion Allowance in Thickness Calcs.		Yes	
Flange Outside Diameter	A	220.000	mm
Flange Thickness	t	25.0000	mm
Flange Material		SA-516 70	
Flange Material UNS number		K02700	
Flange Allowable Stress At Temperature	Sfo	137.90	MPa
Flange Allowable Stress At Ambient	Sfa	137.90	MPa
Bolt Material		SA-193 B7	
Bolt Allowable Stress At Temperature	Sb	172.38	MPa
Bolt Allowable Stress At Ambient	Sa	172.38	MPa
Diameter of the Load Reaction, Long Span	D	0.000	mm
Diameter of the Load Reaction, Short Span	d	0.000	mm
Perimeter along the Center of the Bolts	L	564.230	mm
Diameter of Bolt Circle	C	179.600	mm
Nominal Bolt Diameter	a	12.0000	mm
Type of Threads		TEMA Thread Series	
Number of Bolts		4	
Flange Face Outside Diameter	Fod	165.000	mm
Flange Face Inside Diameter	Fid	155.000	mm
Flange Facing Sketch		1, Code Sketch 1a	
Gasket Outside Diameter	Go	165.000	mm
Gasket Inside Diameter	Gi	155.000	mm
Gasket Factor	m	0.0000	
Gasket Design Seating Stress	y	0.00	MPa
Column for Gasket Seating		2, Code Column II	
Gasket Thickness	tg	2.0000	mm

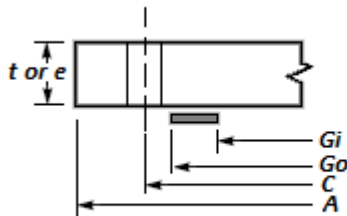

Strength Calculation PV-Elite
 IWS-Monje Heat Exchangers GmbH
 Wittener Str. 102, 44789 Bochum, Germany
 PV Elite 24 Licensee: IWS-Monje? Heat Exchangers GmbH
 FileName : BK12-3102-L800_Airpack-17811_Rev00 -----
 Flg Calc [Int P]: Cover head Flng: 40 11:11am May 5,2022

ASME Code, Section VIII Division 1, 2021

Gasket Contact Width, $N = (G_o - G_i) / 2$ 5.000 mm
 Basic Gasket Width, $b_o = N / 2$ 2.500 mm
 Effective Gasket Width, $b = b_o$ 2.500 mm
 Gasket Reaction Diameter, $G = G_o$ (Self-Energizing) 165.000 mm

Basic Flange and Bolt Loads:

Hydrostatic End Load due to Pressure [H]:

$$= 0.785 * G^2 * P_{eq}$$

$$= 0.785 * 165.0^2 * 1.$$

$$= 21380.648 \text{ N}$$

Contact Load on Gasket Surfaces [Hp]:

$$= 2 * b * \pi * G * m * P$$

$$= 2 * 2.5 * \pi * 165.0 * 0.0 * 1.$$

$$= 0.000 \text{ N}$$

Operating Bolt Load [Wm1]:

$$= \max(H + H_p + H'p, 0)$$

$$= \max(21381 + 0 + 0, 0)$$

$$= 21380.648 \text{ N}$$

Gasket Seating Bolt Load [Wm2]:

$$= y * b * \pi * G + y_{Part} * b_{Part} * l_p$$

$$= 0.0 * 2.5 * \pi * 165.0 + 0.0 * 0.0 * 0.0$$

$$= 0.000 \text{ N}$$

Required Bolt Area [Am]:

$$= \max(W_{m1}/S_b, W_{m2}/S_a)$$

$$= \max(21381/172, 0/172)$$

$$= 124.046 \text{ mm}^2$$

ASME Maximum Circumferential Spacing between Bolts per App. 2 eq. (3) [Bsmax]:

$$= 2a + 6t / (m + 0.5)$$

$$= 2 * 12.7 + 6 * 24.0 / (0.0 + 0.5)$$

$$= 313.400 \text{ mm}$$

Actual Circumferential Bolt Spacing [Bs]:

$$= C * \sin(\pi / n)$$

$$= 179.6 * \sin(\pi / 4)$$

$$= 126.996 \text{ mm}$$

ASME Moment Multiplier for Bolt Spacing per App. 2 eq. (7) [Bsc]:

$$= \max(\sqrt{ Bs / (2a + t) }, 1)$$

$$= \max(\sqrt{ 126.996 / (2 * 12.7 + 24.0) }, 1)$$

$$= 1.6034$$

Bolting Information for TEMA Imperial Thread Series (Non Mandatory):

	Minimum	Actual	Maximum
Bolt Area:	124.046	325.161	
Radial Distance between Bolts and Edge:	15.875	20.200	
Circ. Spacing between the Bolts:	31.750	126.996	313.400

Strength Calculation PV-Elite
 IWS-Monje Heat Exchangers GmbH
 Wittener Str. 102, 44789 Bochum, Germany
 PV Elite 24 Licensee: IWS-Monje? Heat Exchangers GmbH
 FileName : BK12-3102-L800_Airpack-17811_Rev00 -----
 Flg Calc [Int P]: Cover head Flng: 40 11:11am May 5,2022

Flange Design Bolt Load, Gasket Seating [W]:

$$= Sa(A_m + A_b) / 2$$

$$= 172.38(124.0462 + 325.1606)/2$$

$$= 38712.72 \text{ N}$$

Gasket Load for the Operating Condition [HG]:

$$= Wm1$$

$$= 21380.65 \text{ N}$$

Moment Arm Calculations:

Distance to Gasket Load Reaction [hg]:

$$= (C - G) / 2$$

$$= (179.6 - 165.0)/2$$

$$= 7.3000 \text{ mm}$$

Tangential Flange Stress, Flat Head (UG-34), Operating [STo]:

$$= 1.9 * Wm1 * hg * Bsc / (t^2 * G) + C * Z * Peq * G^2 / t^2$$

$$= 1.9 * 21381 * 7.3 * 1.6034 / (24.0^2 * 165.0) + 0.3 * 1.0 * 1. * 165.0^2 / 24.0^2$$

$$= 19.18 \text{ MPa}$$

Tangential Flange Stress, Flat Head (UG-34), Seating [STa]:

$$= 1.9 * W * hg * Bsc / (t^2 * G)$$

$$= 1.9 * 38713 * 7.3 * 1.603 / (24.0^2 * 165.0)$$

$$= 9.06 \text{ MPa}$$

Bolt Stress, Operating [BSo]:

$$= Wm1 / A_b$$

$$= 21381 / 325.1606$$

$$= 65.76 \text{ MPa}$$

Bolt Stress, Seating [BSa]:

$$= (Wm2 / A_b)$$

$$= (0 / 325.1606)$$

$$= 0.00 \text{ MPa}$$

Flange Stress Analysis Results: MPa

	Actual	Operating Allowed	Gasket Seating Actual	Gasket Seating Allowed
Tangential Flange	19.18	137.90	9.06	137.90
Bolting	65.76	172.38	0.00	172.38

Reqd. Blind Flange Thickness at Center	9.951 mm
Reqd. Blind Flange Thickness at Gasket	7.151 mm
Estimated M.A.W.P. (Operating)	3 MPa
Estimated Finished Weight of Flange at given Thk.	7.4 kg
Estimated Unfinished Weight of Forging at given Thk	7.4 kg

Minimum Design Metal Temperature Results:

Thickness Ratio = 0.381, Temperature Reduction per Fig. UCS 66.1 = 56 °C

Min Metal Temp. w/o impact per UCS-66, Curve B	-29 °C
Min Metal Temp. at Required thickness (UCS 66.1)	-48 °C

Strength Calculation PV-Elite
IWS-Monje Heat Exchangers GmbH
Wittener Str. 102, 44789 Bochum, Germany
PV Elite 24 Licensee: IWS-Monje Heat Exchangers GmbH
FileName : BK12-3102-L800_Airpack-17811_Rev00 -----
Flg Calc [Int P]: Cover head Flng: 40 11:11am May 5,2022

PV Elite is a trademark of Hexagon AB, 2022, All rights reserved.

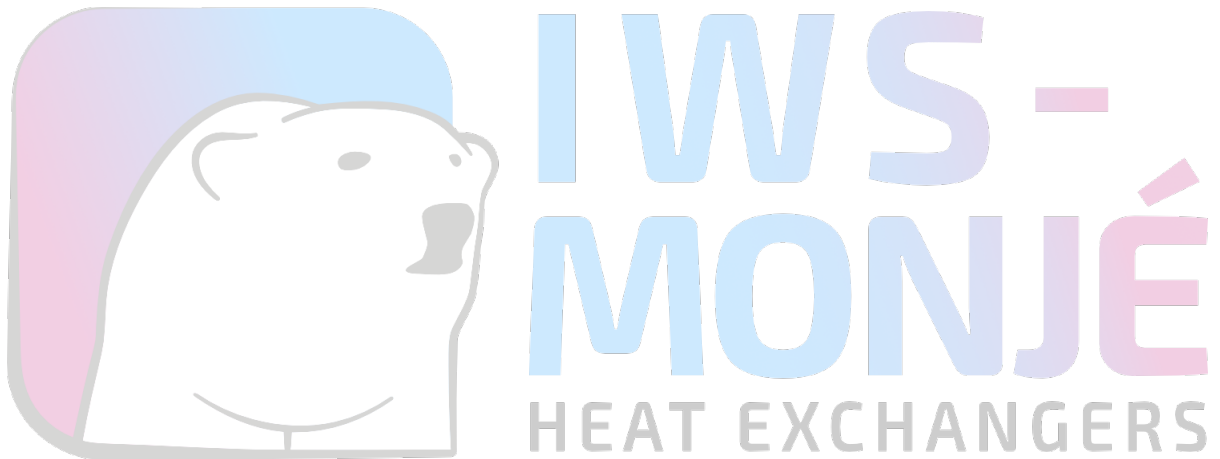

Strength Calculation PV-Elite
 IWS-Monje Heat Exchangers GmbH
 Wittener Str. 102, 44789 Bochum, Germany
 PV Elite 24 Licensee: IWS-Monje? Heat Exchangers GmbH
 FileName : BK12-3102-L800_Airpack-17811_Rev00 -----
 Internal Pressure Calculations: Step: 7 11:11am May 5,2022

Internal Pressure Results Summary:

Element Thickness, Pressure, Diameter and Allowable Stress :

From	To	Int. Press + Liq. Hd MPa	Nominal Thickness mm	Total Corr Allowance mm	Element Diameter mm	Allowable Stress(SE) MPa
Channel head fla		1	27	1	160	137.9
Channel head cyl		1	13	1	160	137.9
Channel head fla		1	18	1	132.6	137.9
Shell flange rin		1	133	131.56
Main Shell		2.5	141.3	132.2
Shell flange rin		1	133	131.6
Cover head		1	...	1	220	137.9

Element Required Thickness and MAWP :

From	To	Design Pressure MPa	M.A.W.P. Corroded MPa	M.A.P. New & Cold MPa	Minimum Thickness mm	Required Thickness mm
Channel head fla		1	25.958	27.9932	27	6.10314
Channel head cyl		1	22.0053	23.9666	13	3.5
Channel head fla		1	1.76016	1.95811	18	14.2494
Shell flange rin		1	1.97362	2.06878	18	12.1412
Main Shell		2.5	6.48694	6.76663	3.4	1.5
Shell flange rin		1	1.97425	2.06878	18	12.1412
Cover head		1	2.62127	2.62127	25	9.95133

Summary of Heat Exchanger Maximum Allowable Working Pressures :

Note:
 For Exchanger designs, the following values include MAWPs that consider the tubesheet, tubes, tube/tubesheet joint etc. These values were determined by iteration. Review the tubesheet analysis report for more information.

Shell Side MAWP = 2 MPa
 Shell Side MAPnc = 2 MPa
 Channel Side MAWP = 1 MPa
 Channel Side MAPnc = 1 MPa

Elements Suitable for Design Internal Pressure.

Internal Pressure Calculation Results:

ASME Code, Section VIII Division 1, 2021

Welded Flat Head From 10 To 20 SA-516 70 , UCS-66 Crv. B at 95 °C

Channel head flat

Longitudinal Joint: User Defined

Strength Calculation PV-Elite
 IWS-Monje Heat Exchangers GmbH
 Wittener Str. 102, 44789 Bochum, Germany
 PV Elite 24 Licensee: IWS-Monje? Heat Exchangers GmbH
 FileName : BK12-3102-L800_Airpack-17811_Rev00 -----
 Internal Pressure Calculations: Step: 7 11:11am May 5,2022

Material UNS Number: K02700

Required Thickness due to Internal Pressure [tr]:
 $= d * \sqrt{Z * C * P / (S * E)}$ per UG-34 (c)(3)
 $= 134.0 * \sqrt{1.0 * 0.2 * 1. / (137.9 * 1.0)}$
 $= 5.1031 + 1.0000 = 6.1031 \text{ mm}$

Max. Allowable Working Pressure at given Thickness, corroded [MAWP]:
 $= (t/d)^2 * ((S * E) / (C * Z))$ per UG-34 (c)(3)
 $= ((26.0) / 134.0)^2 * ((137.9 * 1.0) / (0.2 * 1.0))$
 $= 26 \text{ MPa}$

Maximum Allowable Pressure, New and Cold [MAPNC]:
 $= (t/d)^2 * ((S * E) / (C * Z))$ per UG-34 (c)(3)
 $= (27.0 / 134.0)^2 * ((137.9 * 1.0) / (0.2 * 1.0))$
 $= 28 \text{ MPa}$

Actual stress at given pressure and thickness, corroded [Sact]:
 $= (Z * C * P) / (((t/d)^2) * E)$
 $= (1.0 * 0.2 * 1.0) / (((26.0) / 134.0)^2 * 1.0)$
 $= 5.312 \text{ MPa}$

Minimum Design Metal Temperature Results:

$t_g = 13.0$, $t_{g_sr} = 27.0$, $t_r = 5.103$, $c = 1.0 \text{ mm}$, $E * = 1.0$
 Thickness Ratio = $t_r * E * / (t_{g_sr} - c) = 0.196$, Temp. Reduction = $78 \text{ }^\circ\text{C}$

Min Metal Temp. w/o impact per UCS-66, Curve B	-21 °C
Min Metal Temp. at Required thickness (UCS 66.1)	-104 °C
Min Metal Temp. w/o impact per UG-20(f)	-29 °C

Cylindrical Shell From 20 To 30 SA-516 70 , UCS-66 Crv. B at 95 °C

Channel head cylinder

Longitudinal Joint: User Defined

Material UNS Number: K02700

Required Thickness due to Internal Pressure [tr]:
 $= (P * R_o) / (S * E + 0.4 * P)$ per Appendix 1-1 (a)(1)
 $= (1. * 80.0) / (137.9 * 1.0 + 0.4 * 1.0)$
 $= 0.5785 + 1.0000 = 1.5785 \text{ mm}$

Note: The thickness required was less than the Code Minimum, therefore the Code Minimum value of 2.5000 mm per UG-16 will be used.

Max. Allowable Working Pressure at given Thickness, corroded [MAWP]:
 $= (S * E * t) / (R_o - 0.4 * t)$ per Appendix 1-1 (a)(1)
 $= (137.9 * 1.0 * 12.0) / (80.0 - 0.4 * 12.0)$
 $= 22 \text{ MPa}$

Maximum Allowable Pressure, New and Cold [MAPNC]:
 $= (S * E * t) / (R_o - 0.4 * t)$ per Appendix 1-1 (a)(1)
 $= (137.9 * 1.0 * 13.0) / (80.0 - 0.4 * 13.0)$
 $= 24 \text{ MPa}$

Strength Calculation PV-Elite
 IWS-Monje Heat Exchangers GmbH
 Wittener Str. 102, 44789 Bochum, Germany
 PV Elite 24 Licensee: IWS-Monje? Heat Exchangers GmbH
 FileName : BK12-3102-L800_Airpack-17811_Rev00 -----
 Internal Pressure Calculations: Step: 7 11:11am May 5,2022

Actual stress at given pressure and thickness, corroded [Sact]:

$$\begin{aligned}
 &= (P*(Ro-0.4*t))/(E*t) \\
 &= (1.*((80.0-0.4*12.0))/(1.0*12.0)) \\
 &= 6.267 \text{ MPa}
 \end{aligned}$$

% Elongation per Table UG-79-1 ($50*t_{nom}/R_f*(1-R_f/R_o)$) 8.844 %
 Note: Please Check Requirements of UCS-79 as Elongation is > 5%.

Minimum Design Metal Temperature Results:

Govern. thk, $t_g = 13.0$, $t_r = 2.5$, $c = 1.0$ mm, $E* = 1.0$
 Thickness Ratio = $t_r * E*/(t_g - c) = 0.208$, Temp. Reduction = 78 °C

Min Metal Temp. w/o impact per UCS-66, Curve B	-21 °C
Min Metal Temp. at Required thickness (UCS 66.1)	-104 °C
Min Metal Temp. w/o impact per UG-20(f)	-29 °C

Cylindrical Shell From 50 To 60 SA-312 TP316 at 210 °C

Main Shell

Longitudinal Joint: User Defined

Material UNS Number: S31600

Required Thickness due to Internal Pressure [tr]:

$$\begin{aligned}
 &= (P*Ro) / (S*E+0.4*P) \text{ per Appendix 1-1 (a)(1)} \\
 &= (2.5*70.65)/(132.2*1.0+0.4*2.5) \\
 &= 1.3260 + 0.0000 = 1.3260 \text{ mm}
 \end{aligned}$$

Note: The thickness required was less than the Code Minimum, therefore the Code Minimum value of 1.5000 mm per UG-16 will be used.

Max. Allowable Working Pressure at given Thickness, corroded [MAWP]:

$$\begin{aligned}
 &= (S*E*t)/(Ro-0.4*t) \text{ per Appendix 1-1 (a)(1)} \\
 &= (132.2*1.0*3.4)/(70.65-0.4*3.4) \\
 &= 6 \text{ MPa}
 \end{aligned}$$

Maximum Allowable Pressure, New and Cold [MAPNC]:

$$\begin{aligned}
 &= (S*E*t)/(Ro-0.4*t) \text{ per Appendix 1-1 (a)(1)} \\
 &= (137.9*1.0*3.4)/(70.65-0.4*3.4) \\
 &= 7 \text{ MPa}
 \end{aligned}$$

Actual stress at given pressure and thickness, corroded [Sact]:

$$\begin{aligned}
 &= (P*(Ro-0.4*t))/(E*t) \\
 &= (2.5*((70.65-0.4*3.4))/(1.0*3.4)) \\
 &= 50.949 \text{ MPa}
 \end{aligned}$$

SA-312 TP316, Min Metal Temp without impact per UHA-51: -196 °C

Note: Heads and Shells Exempted to -20F (-29C) by paragraph UG-20F

Hydrostatic Test Pressure Results:

Exchanger Shell Side Hydrostatic Test Pressures:

Strength Calculation PV-Elite

IWS-Monje Heat Exchangers GmbH

Wittener Str. 102, 44789 Bochum, Germany

PV Elite 24 Licensee: IWS-Monje? Heat Exchangers GmbH

FileName : BK12-3102-L800_Airpack-17811_Rev00

Internal Pressure Calculations: Step: 7 11:11am May 5, 2022

Pressure per UG99b	= 1.30 * M.A.W.P. * Sa/S	3.390 MPa
Pressure per UG99b[35]	= 1.30 * Design Pres * Sa/S	3.390 MPa
Pressure per UG99c	= 1.30 * M.A.P. - Head(Hyd)	3.248 MPa
Pressure per UG100	= 1.10 * M.A.W.P. * Sa/S	2.869 MPa
Pressure per PED	= max(1.43*DP, 1.25*DP*ratio)	3.575 MPa
Pressure per App 27-4	= M.A.W.P.	2.500 MPa

User defined Hydrostatic Test Pressures:

Shell Side Test Pressure at High Point	3.750 MPa
Channel Side Test Pressure at High Point	1.500 MPa

Exchanger Channel Side Hydrostatic Test Pressures:

Pressure per UG99b	= 1.30 * M.A.W.P. * Sa/S	1.300 MPa
Pressure per UG99b[35]	= 1.30 * Design Pres * Sa/S	1.300 MPa
Pressure per UG99c	= 1.30 * M.A.P. - Head(Hyd)	1.298 MPa
Pressure per UG100	= 1.10 * M.A.W.P. * Sa/S	1.100 MPa
Pressure per PED	= max(1.43*DP, 1.25*DP*ratio)	1.430 MPa
Pressure per App 27-4	= M.A.W.P.	1.000 MPa

Horizontal Test performed per: User Hydro Pressure

Please note that Nozzle, Shell, Head, Flange, etc MAWPs are all considered when determining the hydrotest pressure for those test types that are based on the MAWP of the vessel.

Stresses on Elements due to Test Pressure (MPa):

From To	Stress	Allowable	Ratio	Pressure
Channel head flat	7.4	179.3	0.041	1.50
Channel head cylinde	8.6	179.3	0.048	1.50
Main Shell	76.5	179.3	0.426	3.75

Stress ratios for Nozzle and Pad Materials (MPa):

Description	Pad/Nozzle	Ambient	Operating	Ratio
Noz N1 Fr10 - Tu	Nozzle	117.90	117.90	1.000
Noz N2 Fr10	Nozzle	117.90	117.90	1.000
Noz N3 - Shell i	Nozzle	117.22	112.32	1.044
Noz N4 - Shell o	Nozzle	117.22	112.32	1.044
Minimum				1.000

Stress ratios for Pressurized Vessel Elements (MPa):

Description	Ambient	Operating	Ratio
Channel head flat	137.90	137.90	1.000
Channel head cylinde	137.90	137.90	1.000
Channel head flange	137.90	137.90	1.000
Shell flange ring 1	137.90	131.56	1.048
Main Shell	137.90	132.20	1.043

Strength Calculation PV-Elite
 IWS-Monje Heat Exchangers GmbH
 Wittener Str. 102, 44789 Bochum, Germany
 PV Elite 24 Licensee: IWS-Monje? Heat Exchangers GmbH
 FileName : BK12-3102-L800_Airpack-17811_Rev00 -----
 Internal Pressure Calculations: Step: 7 11:11am May 5,2022

Shell flange ring 2	137.90	131.60	1.048
Cover head	137.90	137.90	1.000

 Minimum 1.000

Stress ratios for Exchanger Materials (MPa):

Description	Ambient	Operating	Ratio
Tube Material	68.95	59.71	1.155
Tubesheet Material	115.15	97.91	1.176

 Minimum 1.155

Hoop Stress in Nozzle Wall during Pressure Test (MPa):

Description	Ambient	Operating	Ratio
Noz N1 Fr10 - Tu	5.41	153.28	0.035
Noz N2 Fr10	5.41	153.28	0.035
Noz N3 - Shell i	26.78	152.38	0.176
Noz N4 - Shell o	26.78	152.38	0.176

Elements Suitable for Test Pressure.

PV Elite is a trademark of Hexagon AB, 2022, All rights reserved.

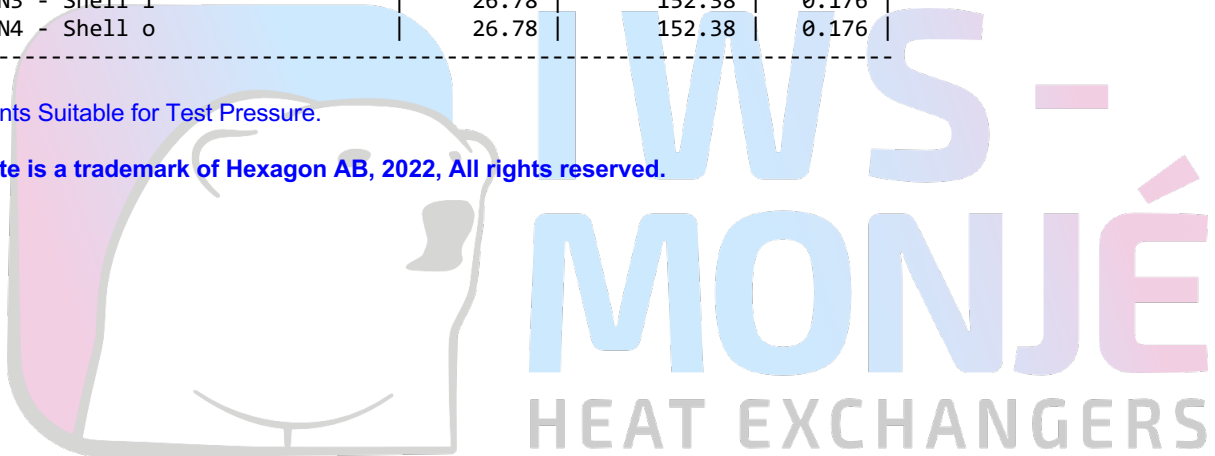

Strength Calculation PV-Elite
 IWS-Monje Heat Exchangers GmbH
 Wittener Str. 102, 44789 Bochum, Germany
 PV Elite 24 Licensee: IWS-Monje? Heat Exchangers GmbH
 FileName : BK12-3102-L800_Airpack-17811_Rev00 -----
 External Pressure Calculations: Step: 8 11:11am May 5,2022

External Pressure Calculation Results :

External Pressure Calculations:

From	To	Section Length mm	Outside Diameter mm	Corroded Thickness mm	Factor A	Factor B MPa
10	20	No Calc	...	26	No Calc	No Calc
20	30	30	160	12	0.096675	122.731
30	40	No Calc	...	17	No Calc	No Calc
40	50	No Calc	...	18	No Calc	No Calc
50	60	753.8	141.3	3.4	0.00082629	58.4069
60	70	No Calc	...	18	No Calc	No Calc
70	80	No Calc	...	24	No Calc	No Calc

External Pressure Calculations:

From	To	External Actual T. mm	External Required T. mm	External Design Pressure MPa	External M.A.W.P. MPa
10	20	27	No Calc	0.1013	No Calc
20	30	13	1.25164	0.1013	12.2731
30	40	18	10.4394	0.1013	No Calc
40	50	18	6.9596	0.1013	No Calc
50	60	3.4	0.95704	0.1013	1.87387
60	70	18	6.9596	0.1013	No Calc
70	80	25	6.9342	0.1013	No Calc

Minimum

2

External Pressure Calculations:

From	To	Actual Length Bet. Stiffeners mm	Allowable Length Bet. Stiffeners mm	Ring Inertia Required mm ⁴	Ring Inertia Available mm ⁴
10	20	No Calc	No Calc	No Calc	No Calc
20	30	30	3634.68	No Calc	No Calc
30	40	No Calc	No Calc	No Calc	No Calc
40	50	No Calc	No Calc	No Calc	No Calc
50	60	753.8	55631.4	No Calc	No Calc
60	70	No Calc	No Calc	No Calc	No Calc
70	80	No Calc	No Calc	No Calc	No Calc

Elements Suitable for External Pressure.

ASME Code, Section VIII Division 1, 2021

Welded Flat Head

Channel head flat

Strength Calculation PV-Elite
 IWS-Monje Heat Exchangers GmbH
 Wittener Str. 102, 44789 Bochum, Germany
 PV Elite 24 Licensee: IWS-Monje Heat Exchangers GmbH
 FileName : BK12-3102-L800_Airpack-17811_Rev00 -----
 External Pressure Calculations: Step: 8 11:11am May 5,2022

Note: This element's required thickness was computed in the internal Pressure Report using the maximum of the Internal and External pressures.

Cylindrical Shell From 50 to 60 Ext. Chart: HA-2 at 210 °C

Main Shell

Elastic Modulus from Chart: HA-2 at 210 °C: 178099 MPa

Results for Maximum Allowable Ext. Pressure							MAEP
Tca	Outer Dia	Slen	Do/t	L/D	Factor A	Factor B	
3.400	141.30	753.80	41.56	5.3347	0.0008263	58.41	

$$MAEP = (4*B)/(3*(Do/t)) = (4*58.4069)/(3*41.5588) = 1.8739 \text{ MPa}$$

Results for Required Thickness							Tca
Tca	Outer Dia	Slen	Do/t	L/D	Factor A	Factor B	
0.957	141.30	753.80	147.64	5.3347	0.0001260	11.22	

$$MAEP = (4*B)/(3*(Do/t)) = (4*11.2178)/(3*147.6435) = 0.1013 \text{ MPa}$$

Results for Maximum Stiffened Length							Slen
Tca	Outer Dia	Slen	Do/t	L/D	Factor A	Factor B	
3.400	141.30	55631.38	41.56	50.0000	0.0006433	54.15	

$$MAEP = (4*B)/(3*(Do/t)) = (4*54.1462)/(3*41.5588) = 1.7372 \text{ MPa}$$

 PV Elite is a trademark of Hexagon AB, 2022, All rights reserved.

Strength Calculation PV-Elite
 IWS-Monje Heat Exchangers GmbH
 Wittener Str. 102, 44789 Bochum, Germany
 PV Elite 24 Licensee: IWS-Monje? Heat Exchangers GmbH
 FileName : BK12-3102-L800_Airpack-17811_Rev00 -----
 Element and Detail Weights: Step: 9 11:11am May 5,2022

Element and Detail Weights:

From	To	Element Metal Wgt. kg	Element ID Volume ltr	Corroded Metal Wgt. kg	Corroded ID Volume ltr	Extra due Misc %
10	20	4.20749	...	4.05166
20	30	1.39592	0.42315	1.29731	0.43588	...
30	40	3.37665	...	3.37665
40	50	3.73074	0.50023	3.73074	0.50023	...
50	60	8.9129	7.98337	8.9129	7.98337	...
60	70	3.73074	0.50023	3.73074	0.50023	...
70	80	7.36555	...	7.36555
Total		32	9.41	32	9.42	0

For elements specified as shell side elements, the volume(s) shown above for those elements, reflects the displacement of the tubes.

Weight of Details:

From	Type	Weight of Detail kg	X Offset, Dtl. Cent. mm	Y Offset, Dtl. Cent. mm	Z Offset Dtl. Cent. mm	Description
10	Noz1	0.30781	...	100	...	Noz N1 Fr10 - Tu
10	Noz1	0.32816	...	-100	...	Noz N2 Fr10
50	Noz1	4.92907	72	-97.4	...	Noz N3 - Shell i
50	Noz1	4.92907	692	97.4	...	Noz N4 - Shell o
30	FTsh	3.79983	36	Tubesheet fix
30	Tube	6.29457	437	Tubes
30	FlTs	2.16206	852	

Total Weight of Each Detail Type:

Nozzles	10.5
Exchanger Components	12.3

Sum of the Detail Weights	22.8 kg

Weight Summation Results: (kg)

	Fabricated	Shop Test	Shipping	Erected	Empty	Operating
Main Elements	32.7	32.7	32.7	32.7	32.7	32.7
Nozzles	10.5	10.5	10.5	10.5	10.5	10.5
Exchanger	12.3	12.3	12.3	12.3	12.3	12.3
Test Liquid	...	9.4
Tube Tst Lqd	...	2.3

Totals	55.5	67.2	55.5	55.5	55.5	55.5

Weight Summary:

Fabricated Wt. - Bare Weight without Removable Internals 55.5 kg

Strength Calculation PV-Elite

IWS-Monje Heat Exchangers GmbH

Wittener Str. 102, 44789 Bochum, Germany

PV Elite 24 Licensee: IWS-Monje? Heat Exchangers GmbH

FileName : BK12-3102-L800_Airpack-17811_Rev00 -----

Element and Detail Weights: Step: 9 11:11am May 5,2022

Shop Test Wt.	- Fabricated Weight + Water (Full)	67.2 kg
Shipping Wt.	- Fab. Weight + removable Intls.+ Shipping App.	55.5 kg
Erected Wt.	- Fab. Wt + or - loose items (trays,platforms etc.)	55.5 kg
Ope. Wt. no Liq	- Fab. Weight + Internals. + Details + Weights	55.5 kg
Operating Wt.	- Empty Weight + Operating Liq. Uncorroded	55.5 kg
Oper. Wt. + CA	- Corr Wt. + Operating Liquid	55.2 kg
Field Test Wt.	- Empty Weight + Water (Full)	67.2 kg

Exchanger Tube Data

Volume of Exchanger tubes :	2.3 ltr
Weight of Ope Liq in tubes :	0.0 kg
Weight of Water in tubes :	2.3 kg

Note:

The Corroded Weight and thickness are used in the Horizontal Vessel Analysis (Ope Case) and Earthquake Load Calculations.

Outside Surface Areas of Elements:

From	To	Surface Area mm ²
10	20	...
20	30	15079.6
30	40	36644.5
40	50	44591
50	60	334617
60	70	44591
70	80	55292
Total		530815.312 mm ²

PV Elite is a trademark of Hexagon AB, 2022, All rights reserved.



IWS-
MONJÉ
HEAT EXCHANGERS

Strength Calculation PV-Elite
 IWS-Monje Heat Exchangers GmbH
 Wittener Str. 102, 44789 Bochum, Germany
 PV Elite 24 Licensee: IWS-Monj? Heat Exchangers GmbH
 FileName : BK12-3102-L800_Airpack-17811_Rev00 -----
 Nozzle Flange MAWP: Step: 10 11:11am May 5,2022

Nozzle Flange MAWP Results: (MPa & °C)

Nozzle Description	Flange Rating		Design Temp	Class	Grade/Group	Equiv. Press	Max Pressure		
	Ope.	Ambient					UG-44(b)	50%	DNV
Noz N3 - Shell	3.52	4.96	210	300	GR 2.2
Noz N4 - Shell	3.52	4.96	210	300	GR 2.2

Shellside Flange Rating

Lowest Flange Pressure Rating was (Ope)[ShellSide]: 3.524 MPa
 Lowest Flange Pressure Rating was (Amb)[ShellSide]: 4.960 MPa

Channelside Flange Rating

Pressure Ratings are per ASME B16.5 2017 Metric Edition

PV Elite is a trademark of Hexagon AB, 2022, All rights reserved.

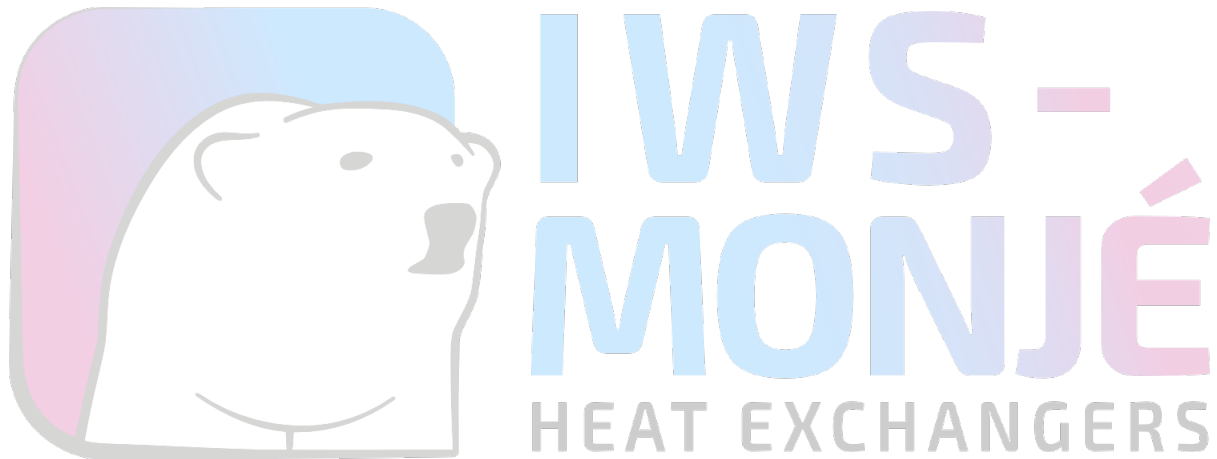

Strength Calculation PV-Elite
 IWS-Monje Heat Exchangers GmbH
 Wittener Str. 102, 44789 Bochum, Germany
 PV Elite 24 Licensee: IWS-Monj? Heat Exchangers GmbH
 FileName : BK12-3102-L800_Airpack-17811_Rev00 -----
 Center of Gravity Calculation: Step: 11 11:11am May 5,2022

Shop/Field Installation Options :

Note : The CG is computed from the first Element From Node

Center of Gravity of the Nozzles	485.222 mm
Center of Gravity of the Tubesheet(s)	406.920 mm
Center of Gravity of the Tubes	512.000 mm
Center of Gravity of Bare Shell New and Cold	478.350 mm
Center of Gravity of Bare Shell Corroded	481.907 mm
Vessel CG in the Operating Condition	477.871 mm
Vessel CG in the Fabricated (Shop/Empty) Condition	475.792 mm

PV Elite is a trademark of Hexagon AB, 2022, All rights reserved.

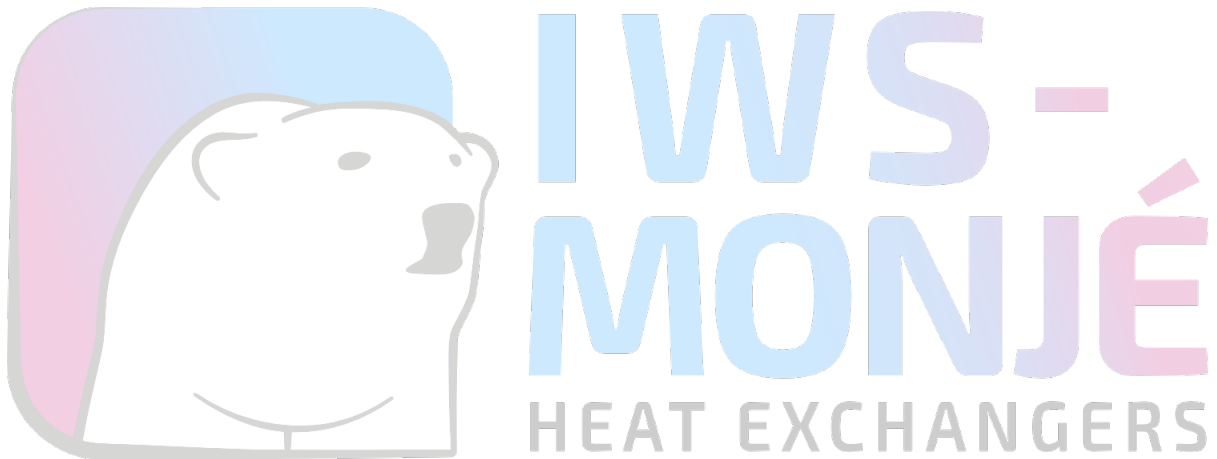

Strength Calculation PV-Elite
 IWS-Monje Heat Exchangers GmbH
 Wittener Str. 102, 44789 Bochum, Germany
 PV Elite 24 Licensee: IWS-Monje? Heat Exchangers GmbH
 FileName : BK12-3102-L800_Airpack-17811_Rev00 -----
 Nozzle Calcs.: Noz N1 Fr10 - T Nozl: 17 11:11am May 5,2022

Input, Nozzle Desc: Noz N1 Fr10 - Tube inlet**From: 10**

Pressure for Reinforcement Calculations	P	1.0000	MPa
Temperature for Internal Pressure	Temp	95	°C
Parent Material		SA-516 70	
Parent Allowable Stress at Temperature	Sv	137.90	MPa
Parent Allowable Stress At Ambient	Sva	137.90	MPa
Outside Diameter of Flat Head	D	160.00	mm
Large Diameter of Flat Head	Dl	160.0000	mm
Flat Head Attachment Factor	F	0.20	
Head Finished (Minimum) Thickness	t	27.0000	mm
Head Internal Corrosion Allowance	c	1.0000	mm
Head External Corrosion Allowance	co	0.0000	mm
Distance from Head Centerline	L1	46.0000	mm
User Entered Minimum Design Metal Temperature		-10.00	°C

Type of Element Connected to the Parent : Nozzle

Material		SA-106 B	
Material UNS Number		K03006	
Material Specification/Type		Smls. pipe	
Allowable Stress at Temperature	Sn	117.90	MPa
Allowable Stress At Ambient	Sna	117.90	MPa
Diameter Basis (for tr calc only)		Outside	
Layout Angle		90.00	deg
Diameter		40.0000	mm
Size and Thickness Basis		Actual	
Actual Thickness	tn	5.0000	mm
Corrosion Allowance	can	1.0000	mm
Joint Efficiency of Shell Seam at Nozzle	E1	1.00	
Joint Efficiency of Nozzle Neck	En	1.00	
Outside Projection	ho	50.0000	mm
Weld leg size between Nozzle and Pad/Shell	Wo	10.0000	mm
Groove weld depth between Nozzle and Vessel	Wgnv	0.0000	mm
Inside Projection	h	0.0000	mm
Weld leg size, Inside Element to Shell	Wi	0.0000	mm

The Pressure Design option was Design Pressure + static head.

Nozzle Sketch (may not represent actual weld type/configuration)

Strength Calculation PV-Elite
 IWS-Monje Heat Exchangers GmbH
 Wittener Str. 102, 44789 Bochum, Germany
 PV Elite 24 Licensee: IWS-Monje? Heat Exchangers GmbH
 FileName : BK12-3102-L800_Airpack-17811_Rev00 -----
 Nozzle Calcs.: Noz N1 Fr10 - T Nozl: 17 11:11am May 5,2022

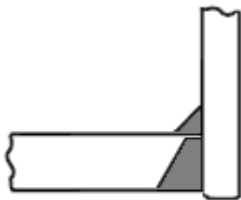

Insert/Set-in Nozzle No Pad, no Inside projection

Reinforcement CALCULATION, Description: Noz N1 Fr10 - Tube inlet

ASME Code, Section VIII, Div. 1, 2021, UG-37 to UG-45

Actual Outside Diameter Used in Calculation 40.000 mm.
 Actual Thickness Used in Calculation 5.000 mm

Nozzle input data check completed without errors.

Reqd thk per UG-37(a) of Welded Flat Head, tr [Int. Press]
 $= d * \sqrt{Z * C * P / (S_v * E)}$ per UG-34 (c)(3)
 $= 134.0 * \sqrt{1.0 * 0.2 * 1. / (138 * 1.0)}$
 $= 5.1031 \text{ mm}$

Reqd thk per UG-37(a) of Nozzle Wall, trn [Int. Press]
 $= P * R_o / (S_n * E + 0.4 * P)$ per Appendix 1-1 (a)(1)
 $= 1. * 20.0 / (118 * 1.0 + 0.4 * 1.)$
 $= 0.1691 \text{ mm}$

UG-40, Limits of Reinforcement : [Internal Pressure]

Parallel to Vessel Wall (Diameter Limit)	D1	92.0000 mm
Parallel to Vessel Wall	Rn+tn+t	46.0000 mm
Normal to Vessel Wall (Thickness Limit), no pad	Tlnp	10.0000 mm

*Taking a UG-36(c)(3)(a) exemption for nozzle: Noz N1 Fr10 - T.
 This calculation is valid for nozzles that meet all the requirements of
 paragraph UG-36. Please check the Code carefully, especially for nozzles
 that are not isolated or do not meet Code spacing requirements. To force
 the computation of areas for small nozzles go to Tools->Configuration
 and check the box to force the UG-37 small nozzle area calculation.*

UG-45 Minimum Nozzle Neck Thickness Requirement: [Int. Press.]

Wall Thickness for Internal/External pressures	ta	= 1.1691 mm
Wall Thickness per UG16(b),	tr16b	= 3.5000 mm
Wall Thickness, shell/head, internal pressure	trb1	= 6.1031 mm
Wall Thickness	tb1 = max(trb1, tr16b)	= 6.1031 mm
Wall Thickness	tb2 = max(trb2, tr16b)	= 3.5000 mm
Wall Thickness per table UG-45	tb3	= 4.1200 mm

Determine Nozzle Thickness candidate [tb]:
 $= \min[tb3, \max(tb1, tb2)]$
 $= \min[4.12, \max(6.1031, 3.5)]$
 $= 4.1200 \text{ mm}$

Strength Calculation PV-Elite
 IWS-Monje Heat Exchangers GmbH
 Wittener Str. 102, 44789 Bochum, Germany
 PV Elite 24 Licensee: IWS-Monje? Heat Exchangers GmbH
 FileName : BK12-3102-L800_Airpack-17811_Rev00 -----
 Nozzle Calcs.: Noz N1 Fr10 - T Nozl: 17 11:11am May 5,2022

Minimum Wall Thickness of Nozzle Necks [tUG-45]:

$$= \max(t_a, t_b)$$

$$= \max(1.1691, 4.12)$$

$$= 4.1200 \text{ mm}$$

Available Nozzle Neck Thickness = 5.0000 mm --> OK

Nozzle Junction Minimum Design Metal Temperature (MDMT) Calculations:

Nozzle-Shell/Head Weld (UCS-66(a)1(b)), Curve: B

Govrn. thk, $t_g = 5.0$, $t_r = 0.169$, $c = 1.0$ mm, $E^* = 1.0$
 Thickness Ratio = $t_r * E^* / (t_g - c) = 0.042$, Temp. Reduction = 78 °C

Min Metal Temp. w/o impact per UCS-66, Curve B -29 °C
 Min Metal Temp. at Required thickness (UCS 66.1) -104 °C

Gov. MDMT of the nozzle to shell joint welded assembly : -104 °C

Weld Size Calculations, Description: Noz N1 Fr10 - T

Intermediate Calc. for nozzle/shell Welds $T_{min} = 4.0000$ mm

Results Per UW-16.1:

	Required Thickness	Actual Thickness
Nozzle Weld	$2.8000 = 0.7 * t_{min}$	$7.0700 = 0.7 * W_o$ mm

Skipping the nozzle attachment weld strength calculations. Per UW-15(b)(2) the nozzles exempted by UG-36(c)(3)(a) (small nozzles) do not require a weld strength check.

Maximum Allowable Pressure for this Nozzle at this Location:

Converged Maximum Allowable Pressure in the Operating case: 1 MPa

Note: The MAWP of this junction was limited by the parent Shell/Head.

The Cut Length for this Nozzle is, Drop + Ho + H + T : 77.0508 mm

PV Elite is a trademark of Hexagon AB, 2022, All rights reserved.

Strength Calculation PV-Elite
 IWS-Monje Heat Exchangers GmbH
 Wittener Str. 102, 44789 Bochum, Germany
 PV Elite 24 Licensee: IWS-Monje? Heat Exchangers GmbH
 FileName : BK12-3102-L800_Airpack-17811_Rev00 -----
 Nozzle Calcs.: Noz N2 Fr10 Nozl: 18 11:11am May 5,2022

Input, Nozzle Desc: Noz N2 Fr10**From: 10**

Pressure for Reinforcement Calculations	P	1.0000	MPa
Temperature for Internal Pressure	Temp	95	°C
Parent Material		SA-516 70	
Parent Allowable Stress at Temperature	Sv	137.90	MPa
Parent Allowable Stress At Ambient	Sva	137.90	MPa
Outside Diameter of Flat Head	D	160.00	mm
Large Diameter of Flat Head	Dl	160.0000	mm
Flat Head Attachment Factor	F	0.20	
Head Finished (Minimum) Thickness	t	27.0000	mm
Head Internal Corrosion Allowance	c	1.0000	mm
Head External Corrosion Allowance	co	0.0000	mm
Distance from Head Centerline	L1	46.0000	mm
User Entered Minimum Design Metal Temperature		-10.00	°C

Type of Element Connected to the Parent : Nozzle

Material		SA-106 B	
Material UNS Number		K03006	
Material Specification/Type		Smls. pipe	
Allowable Stress at Temperature	Sn	117.90	MPa
Allowable Stress At Ambient	Sna	117.90	MPa
Diameter Basis (for tr calc only)		Outside	
Layout Angle		270.00	deg
Diameter		40.0000	mm
Size and Thickness Basis		Actual	
Actual Thickness	tn	5.0000	mm
Corrosion Allowance	can	1.0000	mm
Joint Efficiency of Shell Seam at Nozzle	E1	1.00	
Joint Efficiency of Nozzle Neck	En	1.00	
Outside Projection	ho	50.0000	mm
Weld leg size between Nozzle and Pad/Shell	Wo	10.0000	mm
Groove weld depth between Nozzle and Vessel	Wgnv	0.0000	mm
Inside Projection	h	0.0000	mm
Weld leg size, Inside Element to Shell	Wi	0.0000	mm

The Pressure Design option was Design Pressure + static head.

Nozzle Sketch (may not represent actual weld type/configuration)

Strength Calculation PV-Elite
 IWS-Monje Heat Exchangers GmbH
 Wittener Str. 102, 44789 Bochum, Germany
 PV Elite 24 Licensee: IWS-Monje? Heat Exchangers GmbH
 FileName : BK12-3102-L800_Airpack-17811_Rev00 -----
 Nozzle Calcs.: Noz N2 Fr10 Nozl: 18 11:11am May 5,2022

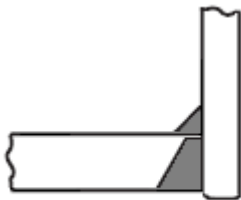

Insert/Set-in Nozzle No Pad, no Inside projection

Reinforcement CALCULATION, Description: Noz N2 Fr10

ASME Code, Section VIII, Div. 1, 2021, UG-37 to UG-45

Actual Outside Diameter Used in Calculation 40.000 mm.
 Actual Thickness Used in Calculation 5.000 mm

Nozzle input data check completed without errors.

Reqd thk per UG-37(a) of Welded Flat Head, tr [Int. Press]
 $= d \cdot \sqrt{Z \cdot C \cdot P / (S_v \cdot E)}$ per UG-34 (c)(3)
 $= 134.0 \cdot \sqrt{1.0 \cdot 0.2 \cdot 1. / (138 \cdot 1.0)}$
 $= 5.1031$ mm

Reqd thk per UG-37(a) of Nozzle Wall, trn [Int. Press]
 $= P \cdot R_o / (S_n \cdot E + 0.4 \cdot P)$ per Appendix 1-1 (a)(1)
 $= 1. \cdot 20.0 / (118 \cdot 1.0 + 0.4 \cdot 1.)$
 $= 0.1691$ mm

UG-40, Limits of Reinforcement : [Internal Pressure]

Parallel to Vessel Wall (Diameter Limit)	D1	92.0000	mm
Parallel to Vessel Wall	Rn+tn+t	46.0000	mm
Normal to Vessel Wall (Thickness Limit), no pad	Tlnp	10.0000	mm

Taking a UG-36(c)(3)(a) exemption for nozzle: Noz N2 Fr10.

This calculation is valid for nozzles that meet all the requirements of paragraph UG-36. Please check the Code carefully, especially for nozzles that are not isolated or do not meet Code spacing requirements. To force the computation of areas for small nozzles go to Tools->Configuration and check the box to force the UG-37 small nozzle area calculation.

UG-45 Minimum Nozzle Neck Thickness Requirement: [Int. Press.]

Wall Thickness for Internal/External pressures	ta	= 1.1691	mm
Wall Thickness per UG16(b),	tr16b	= 3.5000	mm
Wall Thickness, shell/head, internal pressure	trb1	= 6.1031	mm
Wall Thickness	tb1 = max(trb1, tr16b)	= 6.1031	mm
Wall Thickness	tb2 = max(trb2, tr16b)	= 3.5000	mm
Wall Thickness per table UG-45	tb3	= 4.1200	mm

Determine Nozzle Thickness candidate [tb]:

$= \min[tb3, \max(tb1, tb2)]$
 $= \min[4.12, \max(6.1031, 3.5)]$
 $= 4.1200$ mm

Strength Calculation PV-Elite
 IWS-Monje Heat Exchangers GmbH
 Wittener Str. 102, 44789 Bochum, Germany
 PV Elite 24 Licensee: IWS-Monje? Heat Exchangers GmbH
 FileName : BK12-3102-L800_Airpack-17811_Rev00 -----
 Nozzle Calcs.: Noz N2 Fr10 Nozl: 18 11:11am May 5,2022

Minimum Wall Thickness of Nozzle Necks [tUG-45]:
 = max(ta, tb)
 = max(1.1691, 4.12)
 = 4.1200 mm

Available Nozzle Neck Thickness = 5.0000 mm --> OK

Nozzle Junction Minimum Design Metal Temperature (MDMT) Calculations:

Nozzle-Shell/Head Weld (UCS-66(a)1(b)), Curve: B

Govrn. thk, tg = 5.0, tr = 0.169, c = 1.0 mm, E* = 1.0
 Thickness Ratio = tr * E*/(tg - c) = 0.042, Temp. Reduction = 78 °C

Min Metal Temp. w/o impact per UCS-66, Curve B -29 °C
 Min Metal Temp. at Required thickness (UCS 66.1) -104 °C

Gov. MDMT of the nozzle to shell joint welded assembly : -104 °C

Weld Size Calculations, Description: Noz N2 Fr10

Intermediate Calc. for nozzle/shell Welds Tmin 4.0000 mm

Results Per UW-16.1:

	Required Thickness	Actual Thickness
Nozzle Weld	2.8000 = 0.7 * tmin.	7.0700 = 0.7 * Wo mm

Skipping the nozzle attachment weld strength calculations. Per UW-15(b)(2) the nozzles exempted by UG-36(c)(3)(a) (small nozzles) do not require a weld strength check.

Maximum Allowable Pressure for this Nozzle at this Location:

Converged Maximum Allowable Pressure in the Operating case: 1 MPa

Note: The MAWP of this junction was limited by the parent Shell/Head.

The Cut Length for this Nozzle is, Drop + Ho + H + T : 77.0508 mm

PV Elite is a trademark of Hexagon AB, 2022, All rights reserved.

Strength Calculation PV-Elite
 IWS-Monje Heat Exchangers GmbH
 Wittener Str. 102, 44789 Bochum, Germany
 PV Elite 24 Licensee: IWS-Monje? Heat Exchangers GmbH
 FileName : BK12-3102-L800_Airpack-17811_Rev00 -----
 Nozzle Calcs.: Noz N3 - Shell Nozl: 19 11:11am May 5,2022

Input, Nozzle Desc: Noz N3 - Shell inlet**From: 50**

Pressure for Reinforcement Calculations	P	2.5000	MPa
Temperature for Internal Pressure	Temp	210	°C
Design External Pressure	Pext	0.10	MPa
Temperature for External Pressure	Tempex	210	°C

Parent Material		SA-312 TP316	
Parent Allowable Stress at Temperature	Sv	132.20	MPa
Parent Allowable Stress At Ambient	Sva	137.90	MPa

Inside Diameter of Cylindrical Shell	D	134.50	mm
Design Length of Section	L	753.8000	mm
Shell Finished (Minimum) Thickness	t	3.4000	mm
Shell Internal Corrosion Allowance	c	0.0000	mm
Shell External Corrosion Allowance	co	0.0000	mm

Distance from Bottom/Left Tangent		206.52	mm
-----------------------------------	--	--------	----

User Entered Minimum Design Metal Temperature		-10.00	°C
---	--	--------	----

Type of Element Connected to the Parent : Nozzle

Material		SA-312 TP316	
Material UNS Number		S31600	
Material Specification/Type		Wld. pipe	
Allowable Stress at Temperature	Sn	132.14	MPa
Allowable Stress At Ambient	Sna	137.90	MPa

Note: The allowables above have been divided by 0.85, see UG-37 [S].

Diameter Basis (for tr calc only)		Outside	
Layout Angle		270.00	deg
Diameter		60.3000	mm

Size and Thickness Basis		Actual	
Actual Thickness	tn	4.0000	mm

Flange Type		Weld Neck Flange	
-------------	--	------------------	--

Corrosion Allowance	can	0.0000	mm
Joint Efficiency of Shell Seam at Nozzle	E1	1.00	
Joint Efficiency of Nozzle Neck	En	1.00	

Outside Projection	ho	39.0000	mm
Weld leg size between Nozzle and Pad/Shell	Wo	10.0000	mm
Groove weld depth between Nozzle and Vessel	Wgnv	0.0000	mm

Flange Class		300	
Flange Grade		GR 2.2	

The Pressure Design option was Design Pressure + static head.

Nozzle Sketch (may not represent actual weld type/configuration)

Strength Calculation PV-Elite
 IWS-Monje Heat Exchangers GmbH
 Wittener Str. 102, 44789 Bochum, Germany
 PV Elite 24 Licensee: IWS-Monje? Heat Exchangers GmbH
 FileName : BK12-3102-L800_Airpack-17811_Rev00 -----
 Nozzle Calcs.: Noz N3 - Shell Nozl: 19 11:11am May 5,2022

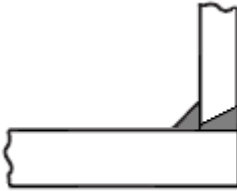

Abutting/Set-on Nozzle No Pad

Reinforcement CALCULATION, Description: Noz N3 - Shell inlet

ASME Code, Section VIII, Div. 1, 2021, UG-37 to UG-45

Actual Outside Diameter Used in Calculation 60.300 mm.
 Actual Thickness Used in Calculation 4.000 mm

Nozzle input data check completed without errors.

Reqd thk per UG-37(a) of Cylindrical Shell, tr [Int. Press]
 = $P \cdot R / (S_v \cdot E - 0.6 \cdot P)$ per UG-27 (c)(1)
 = $2.5 \cdot 67.25 / (132 \cdot 1.0 - 0.6 \cdot 2.5)$
 = 1.2863 mm

Reqd thk per UG-37(a) of Nozzle Wall, trn [Int. Press]
 = $P \cdot R_o / (S_n \cdot E + 0.4 \cdot P)$ per Appendix 1-1 (a)(1)
 = $2.5 \cdot 30.15 / (132 \cdot 1.0 + 0.4 \cdot 2.5)$
 = 0.5661 mm

Required Nozzle thickness under External Pressure per UG-28 : 0.1670 mm

UG-40, Limits of Reinforcement : [Internal Pressure]

Parallel to Vessel Wall (Diameter Limit)	D1	104.6000 mm
Parallel to Vessel Wall, opening length	d	52.3000 mm
Normal to Vessel Wall (Thickness Limit), no pad	Tlnp	8.5000 mm

Taking a UG-36(c)(3)(a) exemption for nozzle: Noz N3 - Shell.

This calculation is valid for nozzles that meet all the requirements of paragraph UG-36. Please check the Code carefully, especially for nozzles that are not isolated or do not meet Code spacing requirements. To force the computation of areas for small nozzles go to Tools->Configuration and check the box to force the UG-37 small nozzle area calculation.

UG-45 Minimum Nozzle Neck Thickness Requirement: [Int. Press.]

Wall Thickness for Internal/External pressures	ta	= 0.5661 mm
Wall Thickness per UG16(b),	tr16b	= 1.5000 mm
Wall Thickness, shell/head, internal pressure	trb1	= 1.2863 mm
Wall Thickness	tb1 = max(trb1, tr16b)	= 1.5000 mm
Wall Thickness	tb2 = max(trb2, tr16b)	= 1.5000 mm
Wall Thickness per table UG-45	tb3	= 3.4200 mm

Determine Nozzle Thickness candidate [tb]:

= min[tb3, max(tb1,tb2)]

Strength Calculation PV-Elite
 IWS-Monje Heat Exchangers GmbH
 Wittener Str. 102, 44789 Bochum, Germany
 PV Elite 24 Licensee: IWS-Monje? Heat Exchangers GmbH
 FileName : BK12-3102-L800_Airpack-17811_Rev00 -----
 Nozzle Calcs.: Noz N3 - Shell Nozl: 19 11:11am May 5,2022

$$= \min[3.42, \max(1.5, 1.5)]$$

$$= 1.5000 \text{ mm}$$

Minimum Wall Thickness of Nozzle Necks [tUG-45]:
 $= \max(t_a, t_b)$
 $= \max(0.5661, 1.5)$
 $= 1.5000 \text{ mm}$

Available Nozzle Neck Thickness = 4.0000 mm --> OK

SA-312 TP316, Min Metal Temp without impact per UHA-51: -196 °C

Weld Size Calculations, Description: Noz N3 - Shell

Intermediate Calc. for nozzle/shell welds t_{min} 3.4000 mm

Results Per UW-16.1:

	Required Thickness	Actual Thickness
Nozzle Weld	$2.3800 = 0.7 * t_{min}$	$7.0700 = 0.7 * W_o$ mm

Skipping the nozzle attachment weld strength calculations. Per UW-15(b)(2) the nozzles exempted by UG-36(c)(3)(a) (small nozzles) do not require a weld strength check.

Maximum Allowable Pressure for this Nozzle at this Location:

Converged Maximum Allowable Pressure in the Operating case: 2 MPa

Note: The MAWP of this junction was limited by the parent Shell/Head.

The Drop for this Nozzle is : 7.1373 mm

The Cut Length for this Nozzle is, Drop + Ho + H + T : 49.5373 mm

PV Elite is a trademark of Hexagon AB, 2022, All rights reserved.

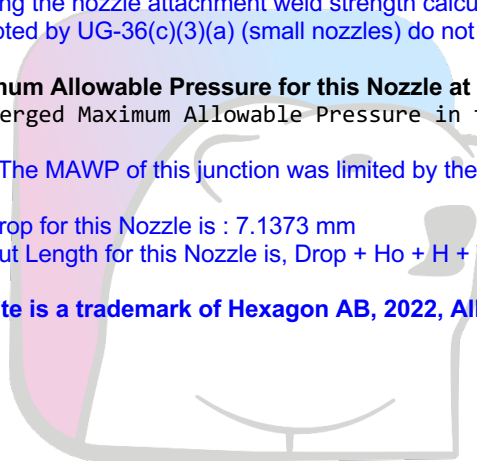

IWS -
 MONJÉ
 HEAT EXCHANGERS

Strength Calculation PV-Elite
 IWS-Monje Heat Exchangers GmbH
 Wittener Str. 102, 44789 Bochum, Germany
 PV Elite 24 Licensee: IWS-Monje? Heat Exchangers GmbH
 FileName : BK12-3102-L800_Airpack-17811_Rev00 -----
 Nozzle Calcs.: Noz N4 - Shell Nozl: 20 11:11am May 5,2022

Input, Nozzle Desc: Noz N4 - Shell outlet**From: 50**

Pressure for Reinforcement Calculations	P	2.5000	MPa
Temperature for Internal Pressure	Temp	210	°C
Design External Pressure	Pext	0.10	MPa
Temperature for External Pressure	Tempex	210	°C

Parent Material		SA-312 TP316	
Parent Allowable Stress at Temperature	Sv	132.20	MPa
Parent Allowable Stress At Ambient	Sva	137.90	MPa

Inside Diameter of Cylindrical Shell	D	134.50	mm
Design Length of Section	L	753.8000	mm
Shell Finished (Minimum) Thickness	t	3.4000	mm
Shell Internal Corrosion Allowance	c	0.0000	mm
Shell External Corrosion Allowance	co	0.0000	mm

Distance from Bottom/Left Tangent		826.53	mm
-----------------------------------	--	--------	----

User Entered Minimum Design Metal Temperature		-10.00	°C
---	--	--------	----

Type of Element Connected to the Parent : Nozzle

Material		SA-312 TP316	
Material UNS Number		S31600	
Material Specification/Type		Wld. pipe	
Allowable Stress at Temperature	Sn	132.14	MPa
Allowable Stress At Ambient	Sna	137.90	MPa

Note: The allowables above have been divided by 0.85, see UG-37 [S].

Diameter Basis (for tr calc only)		Outside	
Layout Angle		90.00	deg
Diameter		60.3000	mm

Size and Thickness Basis		Actual	
Actual Thickness	tn	4.0000	mm

Flange Type		Weld Neck Flange	
-------------	--	------------------	--

Corrosion Allowance	can	0.0000	mm
Joint Efficiency of Shell Seam at Nozzle	E1	1.00	
Joint Efficiency of Nozzle Neck	En	1.00	

Outside Projection	ho	39.0000	mm
Weld leg size between Nozzle and Pad/Shell	Wo	10.0000	mm
Groove weld depth between Nozzle and Vessel	Wgnv	3.4000	mm

Flange Class		300	
Flange Grade		GR 2.2	

The Pressure Design option was Design Pressure + static head.

Nozzle Sketch (may not represent actual weld type/configuration)

Strength Calculation PV-Elite
 IWS-Monje Heat Exchangers GmbH
 Wittener Str. 102, 44789 Bochum, Germany
 PV Elite 24 Licensee: IWS-Monje Heat Exchangers GmbH
 FileName : BK12-3102-L800_Airpack-17811_Rev00 -----
 Nozzle Calcs.: Noz N4 - Shell Nozl: 20 11:11am May 5,2022

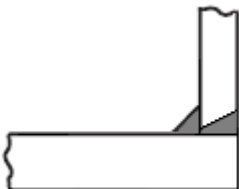

Abutting/Set-on Nozzle No Pad

Reinforcement CALCULATION, Description: Noz N4 - Shell outlet

ASME Code, Section VIII, Div. 1, 2021, UG-37 to UG-45

Actual Outside Diameter Used in Calculation 60.300 mm.
 Actual Thickness Used in Calculation 4.000 mm

Nozzle input data check completed without errors.

Reqd thk per UG-37(a) of Cylindrical Shell, tr [Int. Press]
 = $P \cdot R / (S_v \cdot E - 0.6 \cdot P)$ per UG-27 (c)(1)
 = $2.5 \cdot 67.25 / (132 \cdot 1.0 - 0.6 \cdot 2.5)$
 = 1.2863 mm

Reqd thk per UG-37(a) of Nozzle Wall, trn [Int. Press]
 = $P \cdot R_o / (S_n \cdot E + 0.4 \cdot P)$ per Appendix 1-1 (a)(1)
 = $2.5 \cdot 30.15 / (132 \cdot 1.0 + 0.4 \cdot 2.5)$
 = 0.5661 mm

Required Nozzle thickness under External Pressure per UG-28 : 0.1670 mm

UG-40, Limits of Reinforcement : [Internal Pressure]

Parallel to Vessel Wall (Diameter Limit)	D1	104.6000 mm
Parallel to Vessel Wall, opening length	d	52.3000 mm
Normal to Vessel Wall (Thickness Limit), no pad	Tlnp	8.5000 mm

Taking a UG-36(c)(3)(a) exemption for nozzle: Noz N4 - Shell.

This calculation is valid for nozzles that meet all the requirements of paragraph UG-36. Please check the Code carefully, especially for nozzles that are not isolated or do not meet Code spacing requirements. To force the computation of areas for small nozzles go to Tools->Configuration and check the box to force the UG-37 small nozzle area calculation.

UG-45 Minimum Nozzle Neck Thickness Requirement: [Int. Press.]

Wall Thickness for Internal/External pressures	ta	= 0.5661 mm
Wall Thickness per UG16(b),	tr16b	= 1.5000 mm
Wall Thickness, shell/head, internal pressure	trb1	= 1.2863 mm
Wall Thickness	tb1 = max(trb1, tr16b)	= 1.5000 mm
Wall Thickness	tb2 = max(trb2, tr16b)	= 1.5000 mm
Wall Thickness per table UG-45	tb3	= 3.4200 mm

Determine Nozzle Thickness candidate [tb]:

= min[tb3, max(tb1,tb2)]

Strength Calculation PV-Elite
 IWS-Monje Heat Exchangers GmbH
 Wittener Str. 102, 44789 Bochum, Germany
 PV Elite 24 Licensee: IWS-Monje? Heat Exchangers GmbH
 FileName : BK12-3102-L800_Airpack-17811_Rev00 -----
 Nozzle Calcs.: Noz N4 - Shell Nozl: 20 11:11am May 5,2022

$$= \min[3.42, \max(1.5, 1.5)]$$

$$= 1.5000 \text{ mm}$$

Minimum Wall Thickness of Nozzle Necks [tUG-45]:
 = max(ta, tb)
 = max(0.5661, 1.5)
 = 1.5000 mm

Available Nozzle Neck Thickness = 4.0000 mm --> OK

SA-312 TP316, Min Metal Temp without impact per UHA-51: -196 °C

Weld Size Calculations, Description: Noz N4 - Shell

Intermediate Calc. for nozzle/shell welds Tmin 3.4000 mm

Results Per UW-16.1:

	Required Thickness	Actual Thickness
Nozzle Weld	2.3800 = 0.7 * tmin.	7.0700 = 0.7 * Wo mm

Skipping the nozzle attachment weld strength calculations. Per UW-15(b)(2) the nozzles exempted by UG-36(c)(3)(a) (small nozzles) do not require a weld strength check.

Maximum Allowable Pressure for this Nozzle at this Location:

Converged Maximum Allowable Pressure in the Operating case: 2 MPa

Note: The MAWP of this junction was limited by the parent Shell/Head.

The Drop for this Nozzle is : 7.1373 mm

The Cut Length for this Nozzle is, Drop + Ho + H + T : 49.5373 mm

PV Elite is a trademark of Hexagon AB, 2022, All rights reserved.

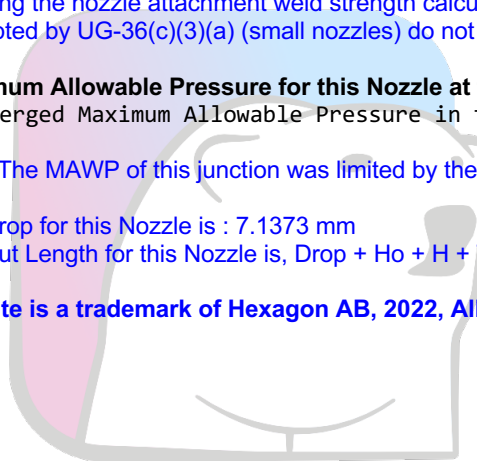

IWS -
 MONJÉ
 HEAT EXCHANGERS

Table of Contents

Cover Sheet.....	2
Vessel Design Summary:	3
Nozzle Summary:.....	5
Nozzle Schedule:	7
Bill of Material:.....	8
MDMT Summary:.....	9
Warnings and Errors:.....	11
Input Echo:.....	12
XY Coordinate Calculations:	19
Flg Calc [Int P]: Channel Fla.....	20
Flg Calc [Int P]: Shell Fl. 1.....	25
Flg Calc [Int P]: Shell Fl. 2.....	30
Flg Calc [Int P]: Cover head.....	35
Internal Pressure Calculations:.....	39
External Pressure Calculations:.....	44
Element and Detail Weights:	46
Nozzle Flange MAWP:.....	48
Center of Gravity Calculation:.....	49
Nozzle Calcs.: Noz N1 Fr10 - T.....	50
Nozzle Calcs.: Noz N2 Fr10.....	53
Nozzle Calcs.: Noz N3 - Shell.....	56
Nozzle Calcs.: Noz N4 - Shell.....	59

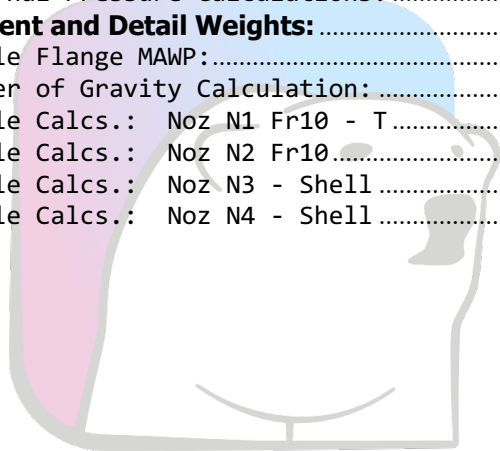

Strength Calculation PV-Elite
IWS-Monje Heat Exchangers GmbH
Wittener Str. 102, 44789 Bochum, Germany

Reference # : Project 17811
Revision # : 00
Client Name : Airpack Nederland BV
Drawing # : K12-3103 / 20-EAC-7080-1

DESIGN CALCULATION

In Accordance with ASME Section VIII Division 1

ASME Code Version : 2021

Analysis Performed by : IWS-Monje Heat Exchangers GmbH

Job File : Y:\Airpack\BK12-3103-L1200_Airpack-17811_Rev00_neuaufbau.pv.pvdb

Date of Analysis : May 5, 2022 1:49am

PV Elite 24, January 2022



Strength Calculation PV-Elite
 IWS-Monje Heat Exchangers GmbH
 Wittener Str. 102, 44789 Bochum, Germany
 PV Elite 24 Licensee: IWS-Monje Heat Exchangers GmbH
 FileName : BK12-3103-L1200_Airpack-17811_Rev00_neuaufbau.pv P
 Vessel Design Summary: Step: 20 1:49am May 5,2022

Vessel Design Summary:

ASME Code, Section VIII Division 1, 2021

Diameter Spec : 160.000 x 141.300 mm OD
 Vessel Design Length, Tangent to Tangent 1362.85 mm
 Specified Datum Line Distance 0.00 mm
 Shell Side Design Temperature 210 °C
 Channel Side Design Temperature 95 °C
 Shell Side Design Pressure 2.500 MPa
 Channel Side Design Pressure 1.000 MPa
 Shop Shell Side Test Pressure 3.750 MPa
 Shop Channel Side Test Pressure 1.500 MPa

Wind Design Code No Wind Loads
 Earthquake Design Code No Seismic

Materials of Construction:

Component Type	Material	Class	Thickness	UNS #	Normal ized	Impact Tested
Shell	SA-516 70	K02700	No	No
Shell	SA-312 TP316	S31600	No	No
Cover	SA-516 70	K02700	No	No
Flange	SA-516 70	K02700	No	No
Flange	SA-182 F316	...	> 5	S31600	No	No
Nozzle	SA-106 B	K03006	No	No
Nozzle	SA-312 TP316	S31600	No	No
Nozzle Flg	SA-182 F316	...	> 5	S31600	No	No
Tubes	SB-111 061	061	...	C70600	No	No
Tubesheet	SB-148 M01	M01	...	C95200	No	No
Flg Bolting	SA-193 B7	...	<= 2 1/2	G41400	No	No

Normalized is determined based on the UCS-66 material curve selection and Figure UCS-66.
 Impact Tested is based on material selection and material data properties.

Element Pressures and MAWP (MPa & mm):

Element Description or Type	Design Pressure + Stat. head	Ext. Press.	Element M.A.W.P	Total Corrosion Allowance	Str. Flg. Gov.	In Creep Range
Channel head flat	1.000	0.10	26.000	1.0000	N/A	No
Channel head cylinder	1.000	0.10	22.000	1.0000	N/A	No
Channel head flange	1.000	0.10	2.000	1.0000	N/A	No
Shell flange ring 1	1.000	0.10	2.000	0.0000	N/A	No
Main Shell	2.500	0.10	6.000	0.0000	N/A	No
Shell flange ring 2	1.000	0.10	2.000	0.0000	N/A	No
Cover head	1.000	0.10	3.000	1.0000	N/A	No

Strength Calculation PV-Elite
 IWS-Monje Heat Exchangers GmbH
 Wittener Str. 102, 44789 Bochum, Germany
 PV Elite 24 Licensee: IWS-Monje? Heat Exchangers GmbH
 FileName : BK12-3103-L1200_Airpack-17811_Rev00_neuaufbau.pv P
 Vessel Design Summary: Step: 20 1:49am May 5,2022

Element Types and Properties:

Element Type	"To" Elev mm	Element Length mm	Nominal Thickness mm	Finished Thickness mm	Reqd Thk Internal mm	Reqd Thk External mm	Long Eff	Circ Eff
Wld Flat	27.0	27.0	27.0	27.0	6.1	...	1.00	1.00
Cylinder	57.0	30.0	13.0	13.0	3.5	1.3	1.00	1.00
Body Flg	57.0	18.0	18.0	18.0	14.2	10.4	1.00	1.00
Body Flg	134.5	36.0	...	18.0	12.1	7.0	1.00	1.00
Cylinder	1288.3	1153.8	...	3.4	1.5	1.2	1.00	1.00
Body Flg	1324.3	36.0	...	18.0	12.1	7.0	1.00	1.00
Body Flg	1362.9	25.0	...	25.0	10.0	6.9	1.00	1.00

Weights:

Fabricated - Bare W/O Removable Internals	63.2	kg
Shop Test - Fabricated + Water (Full)	80.3	kg
Shipping - Fab. + Rem. Intls.+ Shipping App.	63.2	kg
Erected - Fab. + Rem. Intls.+ Insul. (etc)	63.2	kg
Empty - Fab. + Intls. + Details + Wghts.	63.2	kg
Operating - Empty + Operating Liquid (No CA)	63.2	kg
Field Test - Empty Weight + Water (Full)	80.3	kg

PV Elite is a trademark of Hexagon AB, 2022, All rights reserved.

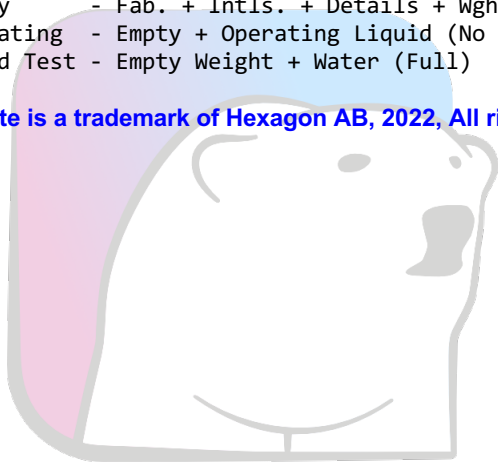

IWS -
 MONJÉ
 HEAT EXCHANGERS

Strength Calculation PV-Elite
 IWS-Monje Heat Exchangers GmbH
 Wittener Str. 102, 44789 Bochum, Germany
 PV Elite 24 Licensee: IWS-Monje? Heat Exchangers GmbH
 FileName : BK12-3103-L1200_Airpack-17811_Rev00_neuaufbau.pv P
 Nozzle Summary: Step: 18 1:49am May 5,2022

Nozzle Calculation Summary (MPa & mm):

Description	MAWP	Ext	MAPNC	UG-45	[tr]	Weld Path	Areas or Stresses
Noz N1 Fr10 - T	1	OK	4.12	OK	No Calc[*]
Noz N2 Fr10	1	OK	4.12	OK	No Calc[*]
Noz N3 - Shell	2	OK	1.50	OK	No Calc[*]
Noz N4 - Shell	2	OK	1.50	OK	No Calc[*]

Nozzle MAWP Summary:

Minimum MAWP Nozzles : 2 Nozzle : Noz N3 - Shell [Shellside]
 Minimum MAWP Nozzles : 1 Nozzle : Noz N1 Fr10 - T [Tubewise]

[*] - This was a small opening and the areas were not computed.

Note: MAWPs (Internal Case) shown above are at the High Point.

Multiple output lines for the same nozzle indicates required Code calculations in both the longitudinal and circumferential planes of reinforcement where applicable.

Check the Spatial Relationship between the Nozzles:

From Node	Nozzle Description	X Coordinate mm	Layout Angle deg	Dia. Limit mm
10	Noz N1 Fr10 - Tu	0.000	90.000	92.000
10	Noz N2 Fr10	0.000	270.000	92.000
50	Noz N3 - Shelli	206.525	90.000	104.600
50	Noz N4 - Shello	1226.525	270.000	104.600

The nozzle spacing is computed by the following:

$$= \sqrt{l_l^2 + l_c^2} \text{ where}$$

l_l - Arc length along the inside vessel surface in the long. direction.

l_c - Arc length along the inside vessel surface in the circ. direction

If any interferences/violations are found, they will be noted below.

No interference violations have been detected!

Checking Multiple Nozzles on Flat Head per ASME Sec. VIII Div. 1 UG-39

Comparing Nozzles on Element: Channel head flat

UG-39 Average Nozzle Diameter and Ligament Checks:

Nozzle Pair Description	Avg. dia. mm	Head Dia. /4 mm	Ligament Width mm	Min. dn /4 mm
Noz N1 Fr10 - Tu & No	32	40	52	8

Strength Calculation PV-Elite
 IWS-Monje Heat Exchangers GmbH
 Wittener Str. 102, 44789 Bochum, Germany
 PV Elite 24 Licensee: IWS-Monje Heat Exchangers GmbH
 FileName : BK12-3103-L1200_Airpack-17811_Rev00_neuaufbau.pv P
 Nozzle Summary: Step: 18 1:49am May 5,2022

UG-39 Nozzle Spacing and Average Area Checks:

Nozzle Pair Description	Center Spacing mm	Avg. dia. * 1.25 mm	Avg. Area Available mm^2	Avg. Area Reqd. mm^2
Noz N1 Fr10 - Tu & No	92	40	No Calc	No Calc

UG-39 Nozzle Diameter and Distance to Edge Checks:

Nozzle Description	Nozzle dia. mm	Head Dia. /2 mm	Distance from Edge mm	Nozzle dia./4 mm
Noz N1 Fr10 - Tu	32	80	27	8
Noz N2 Fr10	32	80	27	8

No Multiple Nozzle spacing violations detected!

PV Elite is a trademark of Hexagon AB, 2022, All rights reserved.

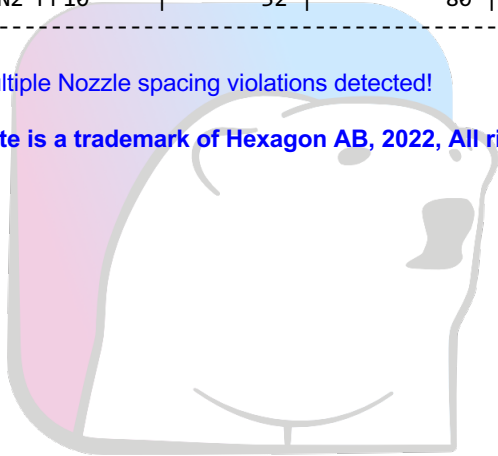

IWS-
MONJÉ
HEAT EXCHANGERS

Strength Calculation PV-Elite
 IWS-Monje Heat Exchangers GmbH
 Wittener Str. 102, 44789 Bochum, Germany
 PV Elite 24 Licensee: IWS-Monje? Heat Exchangers GmbH
 FileName : BK12-3103-L1200_Airpack-17811_Rev00_neuaufbau.pv P
 Nozzle Schedule: Step: 17 1:49am May 5,2022

Nozzle Schedule:

Description	Nominal or Actual Size	Schd or FVC Type	Flg Type	Nozzle O/Dia mm	Wall Thk mm	Reinforcing Pad Diameter	Pad Thk mm	Cut Length mm	Flg Class
Noz N1 Fr10 - Tu	40 mm	Actual	None	40.0	5.000	7	...
Noz N2 Fr10	40 mm	Actual	None	40.0	5.000	7	...
Noz N3 - Shell i	60 mm	Actual	WNF	60.3	4.000	4	300
Noz N4 - Shell o	60 mm	Actual	WNF	60.3	4.000	4	300

General Notes for the above table:

The Cut Length is the Outside Projection + Inside Projection + Drop + In Plane Shell Thickness. This value does not include weld gaps, nor does it account for shrinkage.

In the case of Oblique Nozzles, the Outside Diameter must be increased. The Re-Pad WIDTH around the nozzle is calculated as follows:
 Width of Pad = (Pad Outside Dia. (per above) - Nozzle Outside Dia.)/2

For hub nozzles, the thickness and diameter shown are those of the smaller and thinner section.

Nozzle Material and Weld Fillet Leg Size Details (mm):

Description	Material	Shl Grve Weld	Noz Shl/Pad Weld	Pad OD Weld	Pad Grve Weld	Inside Weld
Noz N1 Fr10	SA-106 B	...	10.000
Noz N2 Fr10	SA-106 B	...	10.000
Noz N3 - Sh	SA-312 TP316	...	10.000
Noz N4 - Sh	SA-312 TP316	3.400	10.000

Note: The Outside projections below do not include the flange thickness.

Nozzle Miscellaneous Data:

Description	Elev/Distance From Datum mm	Layout Angle deg	Proj Outside mm	Proj Inside mm	Installed in Component
Noz N1 Fr10 - Tu	...	90.0	50.00	0.00	Channel head fla
Noz N2 Fr10	...	270.0	50.00	0.00	Channel head fla
Noz N3 - Shell i	206.525	90.0	39.00	0.00	Main Shell
Noz N4 - Shell o	1226.525	270.0	39.00	0.00	Main Shell

PV Elite is a trademark of Hexagon AB, 2022, All rights reserved.

Strength Calculation PV-Elite
 IWS-Monje Heat Exchangers GmbH
 Wittener Str. 102, 44789 Bochum, Germany
 PV Elite 24 Licensee: IWS-Monje? Heat Exchangers GmbH
 FileName : BK12-3103-L1200_Airpack-17811_Rev00_neuaufbau.pv P
 Bill of Material: Step: 16 1:49am May 5,2022

Bill of Materials:

QTY	DESCRIPTION	MATERIAL
1	FLAT HEAD: 27.0mm THK X 160.0mm OD	SA-516 70
1	CYLINDER: 13.0mm THK X 134.0mm ID X 30.0mm	SA-516 70
1	BODY FLANGE: 18.0mm THK X 220.0mm OD	SA-516 70
2	BODY FLANGE: 18.0mm THK X 220.0mm OD	SA-182 F316
1	CYLINDER: 3.4mm THK X 134.5mm ID X 1153.8mm	SA-312 TP316
1	BODY FLANGE: 25.0mm THK X 220.0mm OD	SA-516 70
1	TUBESHEET: 165.0mm X 28.0mm THK	SB-148 M01
72	TUBES: 1230.0mm X 8.0mm DIA X 0.5mm THK	SB-111 061
1	FLOATING TUBESHEET: 132.2mm X 28.0mm THK	SB-148 M01
2	GASKET: 165.0mm OD X 155.0mm ID	...
8	BODY FLANGE BOLTS: 12.0mm DIA	SA-193 B7
16	NUTS FOR BODY FLANGE BOLTS: 12.0mm DIA	...
1	NAMEPLATE	...

PV Elite is a trademark of Hexagon AB, 2022, All rights reserved.

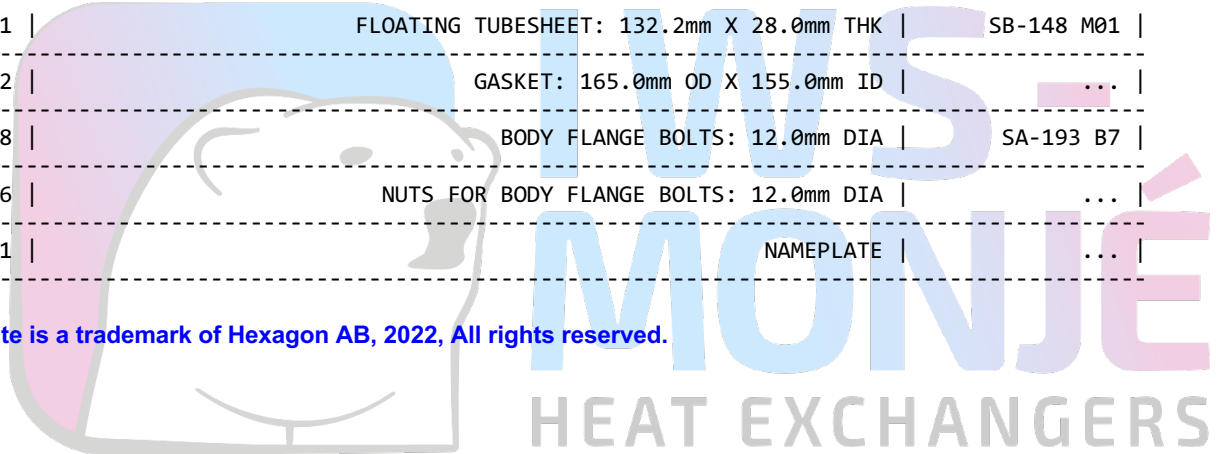

Strength Calculation PV-Elite
 IWS-Monje Heat Exchangers GmbH
 Wittener Str. 102, 44789 Bochum, Germany
 PV Elite 24 Licensee: IWS-Monje? Heat Exchangers GmbH
 FileName : BK12-3103-L1200_Airpack-17811_Rev00_neuaufbau.pv P
 MDMT Summary: Step: 19 1:49am May 5,2022

Minimum Design Metal Temperature Results Summary (°C):

Description	Notes	Curve	Basic MDMT	Reduced MDMT	UG-20(f) MDMT	Thickness ratio	Gov Thk mm	E*	PWHT reqd
Main Shell	[16]		-196						
Noz N3 - Shel	[15]		-196						
Nozzle Flg	[5]		-196						
Noz N4 - Shel	[15]		-196						
Nozzle Flg	[5]		-196						
Nozl. Bolting	[22]		-48			1.000	63.500	1.00	No
Tubesheet: SS	[13]		-18						No

Warmest MDMT: -18

Shell flange	[11]		-196						
Shell flange	[11]		-196						
Cover head	[11]	B	-29	-48	-29	0.381	6.250	1.00	No
Channel head	[12]	B	-21	-104	-29	0.196	13.000	1.00	No
Channel head c	[8]	B	-21	-104	-29	0.208	13.000	1.00	No
Noz N1 Fr10 -	[1]	B	-29	-104	-29	0.042	5.000	1.00	No
Noz N2 Fr10	[1]	B	-29	-104	-29	0.042	5.000	1.00	No
Tubesheet: CS	[14]		-18						No
Bolting	[21]		-48						

Warmest MDMT: -18 -48

Exchanger Side	Computed MDMT	Required MDMT	Pass/Fail
Shell	-18.0	-10.0	Pass
Channel/Tube	-18.0	-10.0	Pass

Notes:

- [!] - This was an impact tested material.
- [1] - Governing Nozzle Weld.
- [4] - ASME Flange MDMT Calcs; Thickness ratio per UCS-66(b)(1)(-c).
- [5] - ASME Flange MDMT Calcs; Thickness ratio per UCS-66(b)(1)(-b).
- [6] - MDMT Calculations at the Shell/Head Joint.
- [7] - MDMT Calculations for the Straight Flange.
- [8] - Cylinder/Cone/Flange Junction MDMT.
- [9] - Calculations in the Spherical Portion of the Head.
- [10] - Calculations in the Knuckle Portion of the Head.
- [11] - Calculated (Body Flange) Flange MDMT.
- [12] - Calculated Flat Head MDMT per UCS-66.3
- [13] - Tubesheet MDMT, shell side, if applicable
- [14] - Tubesheet MDMT, tube side, if applicable
- [15] - Nozzle Material
- [16] - Shell or Head Material
- [17] - Impact Testing required
- [18] - Impact Testing not required, see UCS-66(b)(3)
- [20] - Cylinder/Cone Junction MDMT based on Longitudinal Stress considerations
- [21] - Body Flange Bolting Material
- [22] - Nozzle Flange Bolting Material
- [23] - Stiffening Ring to Shell Weld

Strength Calculation PV-Elite
IWS-Monje Heat Exchangers GmbH
Wittener Str. 102, 44789 Bochum, Germany
PV Elite 24 Licensee: IWS-Monje Heat Exchangers GmbH
FileName : BK12-3103-L1200_Airpack-17811_Rev00_neuaufbau.pv P
MDMT Summary: Step: 19 1:49am May 5,2022

[24] - Saddle to Shell Weld

UG-84(b)(2) was not considered.

UCS-66(g) was not considered.

UCS-66(i) was not considered.

Notes:

Impact test temps were not entered in and not considered in the analysis.

UCS-66(i) applies to impact tested materials not by specification and

UCS-66(g) applies to materials impact tested per UG-84.1 General Note (c).

The Basic MDMT includes the (30F) PWHT credit if applicable.

PV Elite is a trademark of Hexagon AB, 2022, All rights reserved.

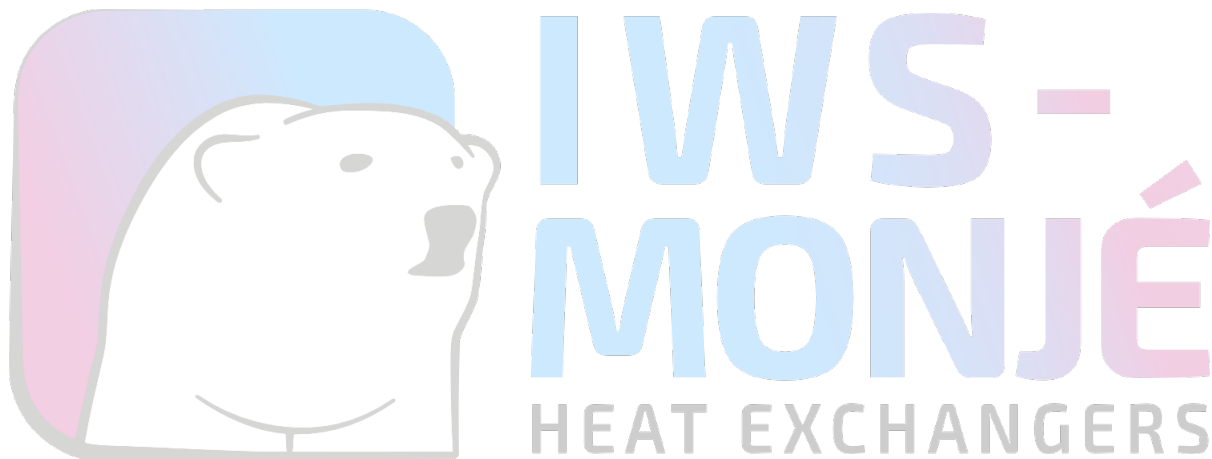

Strength Calculation PV-Elite
IWS-Monje Heat Exchangers GmbH
Wittener Str. 102, 44789 Bochum, Germany
PV Elite 24 Licensee: IWS-Monje Heat Exchangers GmbH
FileName : BK12-3103-L1200_Airpack-17811_Rev00_neuaufbau.pv P
Warnings and Errors: Step: 0 1:49am May 5,2022

Class From To : Basic Element Checks.

Class From To: Check of Additional Element Data

Please insure the C factor entered is in accordance with Figure UG-34.

There were no geometry errors or warnings.

PV Elite performs all calculations internally in Imperial Units to remain compliant with the ASME Code and any built in assumptions in the ASME Code formulas. The finalized results are reflected to show the set of selected units for this analysis.

PV Elite is a trademark of Hexagon AB, 2022, All rights reserved.

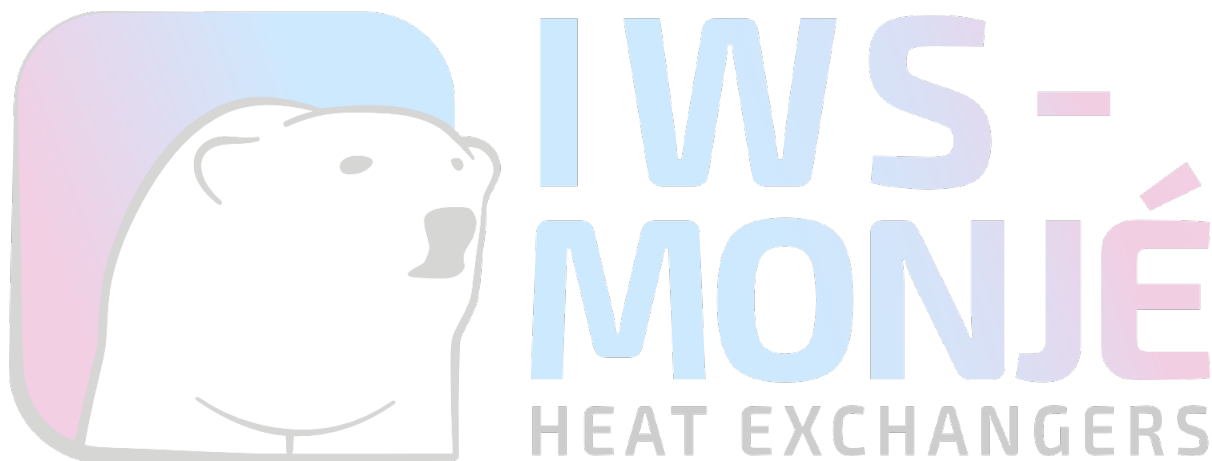

Strength Calculation PV-Elite
 IWS-Monje Heat Exchangers GmbH
 Wittener Str. 102, 44789 Bochum, Germany
 PV Elite 24 Licensee: IWS-Monje? Heat Exchangers GmbH
 FileName : BK12-3103-L1200_Airpack-17811_Rev00_neuaufbau.pv P
 Input Echo: Step: 1 1:49am May 5,2022

Units used in this Analysis (SI_ASME_Unicode):

Name	System Unit	Constant	User Unit
Length	Feet	304.8000	mm
Force	Pounds	4.4480	N
Mass	Pounds	0.4536	kg
Area	sq. inches	645.1600	mm^2
Moment	ft. lbs.	1356.3000	N-mm
Stress	lbs./sq.in.	0.0069	MPa
Temperature	Degrees F	0.5556	°C
Pressure	psig	0.0069	MPa
Elast. Modulus	lbs./sq.in.	0.0069	MPa
Pipe Density	lbs./cu.in.	0.0277	kg/cm^3
Ins. Density	lbs./cu.ft.	0.1602E-04	kg/cm^3
Fluid Density	lbs./cu.ft.	0.1602E-04	kg/cm^3
Wind Speed	miles/hr	1.6093	km/hr
Tray Weight	lbs./sq.ft.	0.0005	kgs/cm^2
Inertia	in.**4	416231.0000	mm^4
G Load	G's	1.0000	g's
Wind Load	lbs./sq.ft.	0.0479	kPa
Elevation	Feet	304.8000	mm
Volume	in.**3	0.0164	ltr
Diameter	inches	25.4000	mm
Thickness	inches	25.4000	mm

PV Elite Vessel Analysis Program: Input Data

Strength Calculation PV-Elite
 IWS-Monje Heat Exchangers GmbH
 Wittener Str. 102, 44789 Bochum, Germany

Exchanger Design Pressures and Temperatures

Shell Side Design Pressure	2.5 MPa
Channel Side Design Pressure	1 MPa
Shell Side Design Temperature	210.0 °C
Channel Side Design Temperature	95.0 °C
Radiography, Shell Side	RT-3
Radiography, Channel Side	RT-1
Service Type, Shell Side	Air/Water/Steam
Service Type, Channel Side	Air/Water/Steam
MDMT (CET), Shell Side	-10.0 °C
MDMT (CET), Tube Side	-10.0 °C
User defined MAWP, Shell Side	2.5 MPa
User defined MAWP, Channel Side	1 MPa
User defined MAPnc, Shell Side	2.5 MPa
User defined MAPnc, Channel Side	1 MPa
User defined Test Pres., Shell Side	3.75 MPa
User defined Test Pres., Channel Side	1.5 MPa

Projection of Nozzle from Vessel Top	0 mm
Projection of Nozzle from Vessel Bottom	0 mm

Strength Calculation PV-Elite

IWS-Monje Heat Exchangers GmbH

Wittener Str. 102, 44789 Bochum, Germany

PV Elite 24 Licensee: IWS-Monje? Heat Exchangers GmbH

FileName : BK12-3103-L1200_Airpack-17811_Rev00_neuaufbau.pv P

Input Echo: Step: 1 1:49am May 5,2022

Type of Construction	Welded
Use Higher Longitudinal Stresses (Flag)	N
Select t for Internal Pressure (Flag)	N
Select t for External Pressure (Flag)	N
Select t for Axial Stress (Flag)	N
Select Location for Stiff. Rings (Flag)	N
Consider Vortex Shedding	N

Shop Pressure Test:

Type of Pressure Test	User Entered Pressure
Pressure Test Position	Horizontal
Load Case 1	NP+EW+WI+FW+BW
Load Case 2	NP+EW+EE+FS+BS
Load Case 3	NP+OW+WI+FW+BW
Load Case 4	NP+OW+EQ+FS+BS
Load Case 5	NP+HW+HI
Load Case 6	NP+HW+HE
Load Case 7	IP+OW+WI+FW+BW
Load Case 8	IP+OW+EQ+FS+BS
Load Case 9	EP+OW+WI+FW+BW
Load Case 10	EP+OW+EQ+FS+BS
Load Case 11	HP+HW+HI
Load Case 12	HP+HW+HE
Load Case 13	IP+WE+EW
Load Case 14	IP+WF+CW
Load Case 15	IP+VO+OW
Load Case 16	IP+VE+EW
Load Case 17	NP+VO+OW
Load Case 18	FS+BS+IP+OW
Load Case 19	FS+BS+EP+OW
Load Case 20	BL+IP+OW
Wind Design Code	No Wind Loads
Seismic Design Code	No Seismic
Design Pressure + Static Head	Y
Consider MAP New and Cold in Noz. Design	N
Consider External Loads for Nozzle Des.	Y
Use ASME VIII-1 Appendix 1-9	N
Perform Blast Load Analysis	No
Material Database Year	Current w/Addenda or Code Year

Configuration Directives:

Do not use Nozzle MDMT Interpretation VIII-1 01-37	No
Use Table G instead of exact equation for "A"	Yes
Shell Head Joints are Tapered	Yes
Compute "K" in corroded condition	Yes
Use Code Case 2286	No
Use the MAWP to compute the MDMT	Yes
For thickness ratios ≤ 0.35 , MDMT will be -155F (-104C)	Yes
For PWHT & P1 Materials the MDMT can be $< -55F (-48C)$	No
Using Metric Material Databases, ASME II D	No

Strength Calculation PV-Elite
 IWS-Monje Heat Exchangers GmbH
 Wittener Str. 102, 44789 Bochum, Germany
 PV Elite 24 Licensee: IWS-Monje? Heat Exchangers GmbH
 FileName : BK12-3103-L1200_Airpack-17811_Rev00_neuaufbau.pv P
 Input Echo: Step: 1 1:49am May 5,2022

Calculate B31.3 type stress for Nozzles with Loads Yes
 Reduce the MDMT due to lower membrane stress Yes
 Consider Longitudinal Stress in MDMT Calculations Yes

Complete Listing of Vessel Elements and Details:

Element From Node 10
 Element To Node 20
 Element Type Flat
 Description Channel head flat
 Distance "FROM" to "TO" 27 mm
 Element Outside Diameter 160 mm
 Element Thickness 27 mm
 Internal Corrosion Allowance 1 mm
 Nominal Thickness 27 mm
 External Corrosion Allowance 0 mm
 Design Internal Pressure 1 MPa
 Design Temperature Internal Pressure 95 °C
 Design External Pressure 0.1013 MPa
 Design Temperature External Pressure 95 °C
 Effective Diameter Multiplier 1.0
 Material Name SA-516 70
 Allowable Stress, Ambient 137.9 MPa
 Allowable Stress, Operating 137.9 MPa
 Allowable Stress, Hydrotest 179.27 MPa
 Material Density 0.00775 kg/cm³
 P Number Thickness 31.75 mm
 Yield Stress, Operating 239.7 MPa
 UCS-66 Chart Curve Designation B
 External Pressure Chart Name CS-2
 UNS Number K02700
 Product Form Plate
 Efficiency, Longitudinal Seam 1.0
 Efficiency, Circumferential Seam 1.0
 Flat Head Attachment Factor 0.2
 Small diameter if Non-Circular 0 mm
 Weld is pre-Heated No

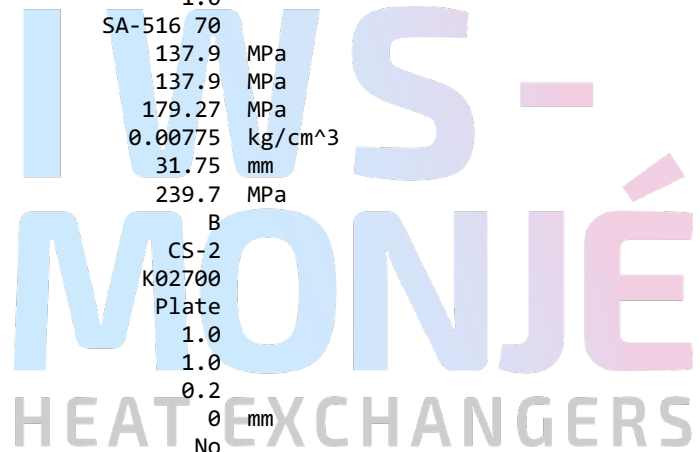

Element From Node 10
 Detail Type Nozzle
 Detail ID Noz N1 Fr10 - Tu
 Dist. from "FROM" Node / Offset dist 46 mm
 Nozzle Diameter 40 mm
 Nozzle Schedule 40
 Nozzle Class None
 Layout Angle 90.0
 Blind Flange (Y/N) N
 Weight of Nozzle (Used if > 0) 3.0184 N
 Grade of Attached Flange None
 Nozzle Matl SA-106 B

Element From Node 10
 Detail Type Nozzle
 Detail ID Noz N2 Fr10
 Dist. from "FROM" Node / Offset dist 46 mm
 Nozzle Diameter 40 mm
 Nozzle Schedule 40

Strength Calculation PV-Elite
 IWS-Monje Heat Exchangers GmbH
 Wittener Str. 102, 44789 Bochum, Germany
 PV Elite 24 Licensee: IWS-Monj? Heat Exchangers GmbH
 FileName : BK12-3103-L1200_Airpack-17811_Rev00_neuaufbau.pv P
 Input Echo: Step: 1 1:49am May 5,2022

Nozzle Class	None
Layout Angle	270.0
Blind Flange (Y/N)	N
Weight of Nozzle (Used if > 0)	0 N
Grade of Attached Flange	None
Nozzle Matl	SA-106 B

Element From Node	20
Element To Node	30
Element Type	Cylinder ! Atype
Description	Channel head cylinder
Distance "FROM" to "TO"	30 mm
Element Outside Diameter	160 mm
Element Thickness	13 mm
Internal Corrosion Allowance	1 mm
Nominal Thickness	13 mm
External Corrosion Allowance	0 mm
Design Internal Pressure	1 MPa
Design Temperature Internal Pressure	95 °C
Design External Pressure	0.1013 MPa
Design Temperature External Pressure	95 °C
Effective Diameter Multiplier	1.0
Material Name	SA-516 70
Efficiency, Longitudinal Seam	1.0
Efficiency, Circumferential Seam	1.0
Weld is pre-Heated	No

Element From Node	30
Element To Node	40
Element Type	Flange
Description	Channel head flange
Distance "FROM" to "TO"	18 mm
Flange Inside Diameter	132.6 mm
Element Thickness	18 mm
Internal Corrosion Allowance	1 mm
Nominal Thickness	18 mm
External Corrosion Allowance	0 mm
Design Internal Pressure	1 MPa
Design Temperature Internal Pressure	95 °C
Design External Pressure	0.1013 MPa
Design Temperature External Pressure	95 °C
Effective Diameter Multiplier	1.0
Material Name	SA-516 70
Perform Flange Stress Calculation (Y/N)	Y
Weld is pre-Heated	No

Element From Node	40
Element To Node	50
Element Type	Flange
Description	Shell flange ring 1
Distance "FROM" to "TO"	36 mm

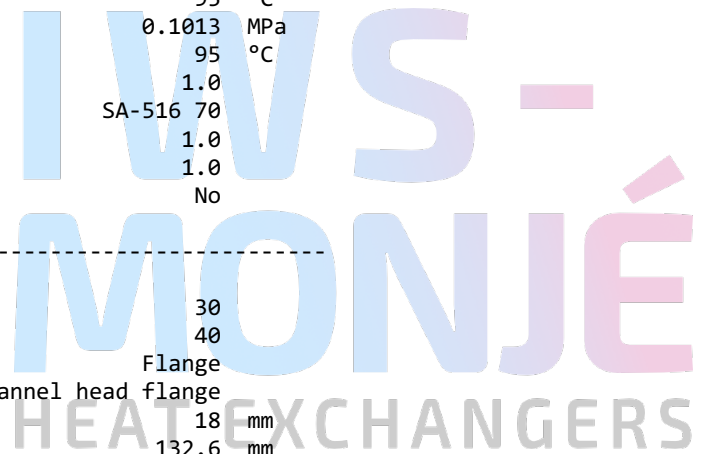

Strength Calculation PV-Elite
 IWS-Monje Heat Exchangers GmbH
 Wittener Str. 102, 44789 Bochum, Germany
 PV Elite 24 Licensee: IWS-Monje? Heat Exchangers GmbH
 FileName : BK12-3103-L1200_Airpack-17811_Rev00_neuaufbau.pv P
 Input Echo: Step: 1 1:49am May 5,2022

Flange Inside Diameter	133	mm
Element Thickness	18	mm
Internal Corrosion Allowance	0	mm
Nominal Thickness	0	mm
External Corrosion Allowance	0	mm
Design Internal Pressure	1	MPa
Design Temperature Internal Pressure	210	°C
Design External Pressure	0.1013	MPa
Design Temperature External Pressure	210	°C
Effective Diameter Multiplier	1.0	
Material Name	SA-182 F316	
Allowable Stress, Ambient	137.9	MPa
Allowable Stress, Operating	131.56	MPa
Allowable Stress, Hydrotest	179.27	MPa
Material Density	0.008027	kg/cm^3
P Number Thickness	0	mm
Yield Stress, Operating	146.59	MPa
External Pressure Chart Name	HA-2	
UNS Number	S31600	
Class / Thickness / Grade	:: > 5	
Product Form	Forgings	
Perform Flange Stress Calculation (Y/N)	Y	
Weld is pre-Heated	No	

Element From Node	50	
Element To Node	60	
Element Type	Cylinder	
Description	! Atype Main Shell	
Distance "FROM" to "TO"	1153.8	mm
Element Outside Diameter	141.3	mm
Element Thickness	3.4	mm
Internal Corrosion Allowance	0	mm
Nominal Thickness	0	mm
External Corrosion Allowance	0	mm
Design Internal Pressure	2.5	MPa
Design Temperature Internal Pressure	210	°C
Design External Pressure	0.1013	MPa
Design Temperature External Pressure	210	°C
Effective Diameter Multiplier	1.0	
Material Name	SA-312 TP316	
Allowable Stress, Ambient	137.9	MPa
Allowable Stress, Operating	132.2	MPa
Allowable Stress, Hydrotest	179.3	MPa
Material Density	0.008027	kg/cm^3
P Number Thickness	0	mm
Yield Stress, Operating	146.6	MPa
External Pressure Chart Name	HA-2	
UNS Number	S31600	
Product Form	Smls. & wld. pipe	
Efficiency, Longitudinal Seam	1.0	
Efficiency, Circumferential Seam	1.0	
Weld is pre-Heated	No	

Element From Node	50	
Detail Type	Nozzle	

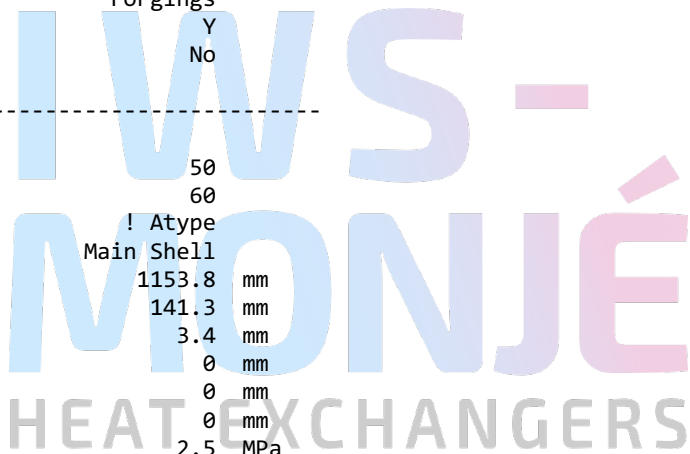

Strength Calculation PV-Elite

IWS-Monje Heat Exchangers GmbH

Wittener Str. 102, 44789 Bochum, Germany

PV Elite 24 Licensee: IWS-Monje? Heat Exchangers GmbH

FileName : BK12-3103-L1200_Airpack-17811_Rev00_neuaufbau.pv P

Input Echo: Step: 1 1:49am May 5,2022

Detail ID	Noz N3 - Shell i	
Dist. from "FROM" Node / Offset dist	72	mm
Nozzle Diameter	60.3	mm
Nozzle Schedule	40	
Nozzle Class	300	
Layout Angle	90.0	
Blind Flange (Y/N)	N	
Weight of Nozzle (Used if > 0)	0	N
Grade of Attached Flange	GR 2.2	
Nozzle Matl	SA-312 TP316	

Element From Node	50	
Detail Type	Nozzle	
Detail ID	Noz N4 - Shell o	
Dist. from "FROM" Node / Offset dist	1092	mm
Nozzle Diameter	60.3	mm
Nozzle Schedule	40	
Nozzle Class	300	
Layout Angle	270.0	
Blind Flange (Y/N)	N	
Weight of Nozzle (Used if > 0)	0	N
Grade of Attached Flange	GR 2.2	
Nozzle Matl	SA-312 TP316	

Element From Node	60	
Element To Node	70	
Element Type	Flange	
Description	Shell flange ring 2	
Distance "FROM" to "TO"	36	mm
Flange Inside Diameter	133	mm
Element Thickness	18	mm
Internal Corrosion Allowance	0	mm
Nominal Thickness	0	mm
External Corrosion Allowance	0	mm
Design Internal Pressure	1	MPa
Design Temperature Internal Pressure	210	°C
Design External Pressure	0.1013	MPa
Design Temperature External Pressure	210	°C
Effective Diameter Multiplier	1.0	
Material Name	SA-182 F316	
Allowable Stress, Ambient	137.9	MPa
Allowable Stress, Operating	131.6	MPa
Allowable Stress, Hydrotest	179.3	MPa
Material Density	0.008027	kg/cm^3
P Number Thickness	0	mm
Yield Stress, Operating	146.6	MPa
External Pressure Chart Name	HA-2	
UNS Number	S31600	
Class / Thickness / Grade	:: > 5	
Product Form	Forgings	
Perform Flange Stress Calculation (Y/N)	Y	
Weld is pre-Heated	No	

Strength Calculation PV-Elite
 IWS-Monje Heat Exchangers GmbH
 Wittener Str. 102, 44789 Bochum, Germany
 PV Elite 24 Licensee: IWS-Monje? Heat Exchangers GmbH
 FileName : BK12-3103-L1200_Airpack-17811_Rev00_neuaufbau.pv P
 Input Echo: Step: 1 1:49am May 5,2022

Element From Node	70
Element To Node	80
Element Type	Flange
Description	Cover head
Distance "FROM" to "TO"	25 mm
Flange Outside Diameter	220 mm
Element Thickness	25 mm
Internal Corrosion Allowance	1 mm
Nominal Thickness	0 mm
External Corrosion Allowance	0 mm
Design Internal Pressure	1 MPa
Design Temperature Internal Pressure	95 °C
Design External Pressure	0.1013 MPa
Design Temperature External Pressure	95 °C
Effective Diameter Multiplier	1.0
Material Name	SA-516 70
Allowable Stress, Ambient	137.9 MPa
Allowable Stress, Operating	137.9 MPa
Allowable Stress, Hydrotest	179.3 MPa
Material Density	0.00775 kg/cm ³
P Number Thickness	30.988 mm
Yield Stress, Operating	239.7 MPa
UCS-66 Chart Curve Designation	B
External Pressure Chart Name	CS-2
UNS Number	K02700
Product Form	Plate
Perform Flange Stress Calculation (Y/N)	Y
Weld is pre-Heated	No

PV Elite is a trademark of Hexagon AB, 2022, All rights reserved.

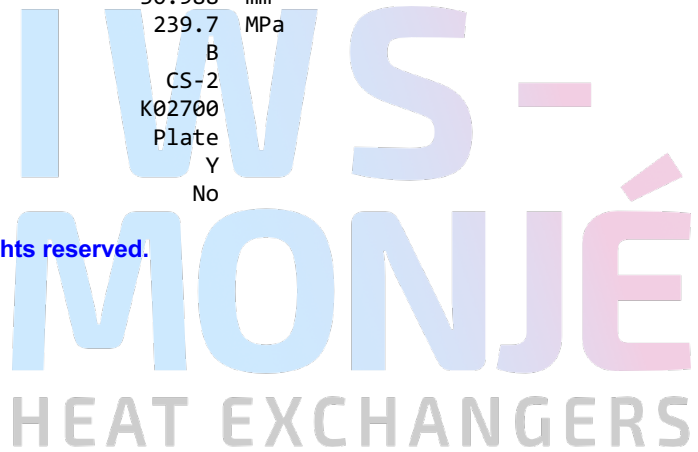
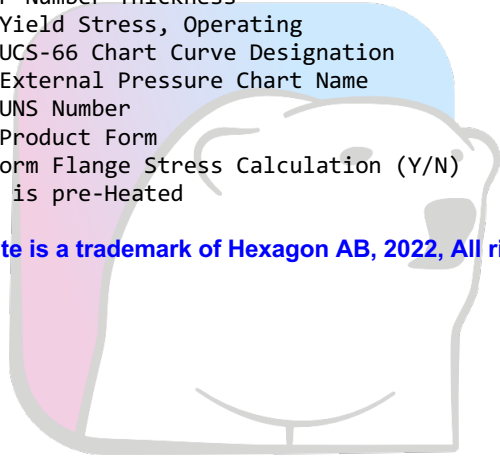

Strength Calculation PV-Elite
 IWS-Monje Heat Exchangers GmbH
 Wittener Str. 102, 44789 Bochum, Germany
 PV Elite 24 Licensee: IWS-Monj? Heat Exchangers GmbH
 FileName : BK12-3103-L1200_Airpack-17811_Rev00_neuaufbau.pv P
 XY Coordinate Calculations: Step: 2 1:49am May 5,2022

XY Coordinate Calculations:

From	To	X (Horiz.) mm	Y (Vert.) mm	DX (Horiz.) mm	DY (Vert.) mm
Channel head fl		27	...	27	...
Channel head cy		57	...	30	...
Channel head fl		57	...	-18	...
Shell flange ri		134.525	...	36	...
Main Shell		1288.33	...	1153.8	...
Shell flange ri		1324.33	...	36	...
Cover head		1362.85	...	25	...

PV Elite includes an 1/8 inch (3.175mm) raised face and gasket thicknesses for girth flanges and tubesheet thicknesses where applicable in the Tangent to Tangent length calculation. The calculated dimensions are based on the given element lengths. Due to variability in manufacturing (weld gaps etc.), the Tangent to Tangent length may not be exact.

PV Elite is a trademark of Hexagon AB, 2022, All rights reserved.



Strength Calculation PV-Elite
 IWS-Monje Heat Exchangers GmbH
 Wittener Str. 102, 44789 Bochum, Germany
 PV Elite 24 Licensee: IWS-Monje? Heat Exchangers GmbH
 FileName : BK12-3103-L1200_Airpack-17811_Rev00_neuaufbau.pv P
 Flg Calc [Int P]: Channel Fla. Flng: 37 1:49am May 5,2022

Flange Input Data Values

Description: Channel Fla. :

Channel head flange

Flange Type		Integral Ring	
Design Pressure	P	1.00	MPa
Design Temperature		95	°C
Internal Corrosion Allowance	ci	1.0000	mm
External Corrosion Allowance	ce	0.0000	mm
Use Corrosion Allowance in Thickness Calcs.		Yes	
Attached Shell Inside Diameter	B	132.6000	mm
Integral Ring Inside Diameter		158.6000	mm
Flange Outside Diameter	A	220.000	mm
Flange Thickness	t	18.0000	mm
Flange Material		SA-516 70	
Flange Material UNS number		K02700	
Flange Allowable Stress At Temperature	Sfo	137.90	MPa
Flange Allowable Stress At Ambient	Sfa	137.90	MPa
Bolt Material		SA-193 B7	
Bolt Allowable Stress At Temperature	Sb	172.38	MPa
Bolt Allowable Stress At Ambient	Sa	172.38	MPa
Length of Weld Leg at Back of Ring	tw	0.0000	mm
Diameter of Bolt Circle	C	179.600	mm
Nominal Bolt Diameter	a	12.0000	mm
Type of Threads		TEMA Thread Series	
Number of Bolts		4	
Flange Face Outside Diameter	Fod	165.000	mm
Flange Face Inside Diameter	Fid	155.000	mm
Flange Facing Sketch		1, Code Sketch 1a	
Gasket Outside Diameter	Go	165.000	mm
Gasket Inside Diameter	Gi	155.000	mm
Gasket Factor	m	0.0000	
Gasket Design Seating Stress	y	0.00	MPa
Column for Gasket Seating		2, Code Column II	
Gasket Thickness	tg	2.0000	mm

Strength Calculation PV-Elite
 IWS-Monje Heat Exchangers GmbH
 Wittener Str. 102, 44789 Bochum, Germany
 PV Elite 24 Licensee: IWS-Monje Heat Exchangers GmbH
 FileName : BK12-3103-L1200_Airpack-17811_Rev00_neuaufbau.pv P
 Flg Calc [Int P]: Channel Fla. Flng: 37 1:49am May 5,2022

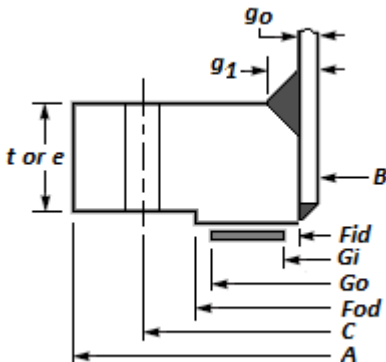

ASME Code, Section VIII Division 1, 2021

Corroded Flange Thickness, $t_c = T - c_i$	17.000 mm
Corroded Flange ID, $B_{cor} = B + 2 * F_{cor}$	134.600 mm
Corroded Large Hub, $g1_{cor} = g1 - c_i$	0.000 mm
Corroded Small Hub, $g0_{cor} = g0 - c_i$	0.000 mm
Code R Dimension, $R = ((C - B_{cor}) / 2) - g1_{cor}$	22.500 mm
Gasket Contact Width, $N = (G_o - G_i) / 2$	5.000 mm
Basic Gasket Width, $b_o = N / 2$	2.500 mm
Effective Gasket Width, $b = b_o$	2.500 mm
Gasket Reaction Diameter, $G = G_o$ (Self-Energizing)	165.000 mm

Basic Flange and Bolt Loads:

Hydrostatic End Load due to Pressure [H]:
 $= 0.785 * G^2 * P_{eq}$
 $= 0.785 * 165.0^2 * 1.$
 $= 21380.648 \text{ N}$

Contact Load on Gasket Surfaces [Hp]:
 $= 2 * b * \pi * G * m * P$
 $= 2 * 2.5 * \pi * 165.0 * 0.0 * 1.$
 $= 0.000 \text{ N}$

Hydrostatic End Load at Flange ID [Hd]:
 $= \pi * B_{cor}^2 * P / 4$
 $= \pi * 134.6^2 * 1. / 4$
 $= 14227.976 \text{ N}$

Pressure Force on Flange Face [Ht]:
 $= H - H_d$
 $= 21381 - 14228$
 $= 7152.672 \text{ N}$

Operating Bolt Load [Wm1]:
 $= \max(H + H_p + H'p, 0)$
 $= \max(21381 + 0 + 0, 0)$
 $= 21380.648 \text{ N}$

Strength Calculation PV-Elite
 IWS-Monje Heat Exchangers GmbH
 Wittener Str. 102, 44789 Bochum, Germany
 PV Elite 24 Licensee: IWS-Monje? Heat Exchangers GmbH
 FileName : BK12-3103-L1200_Airpack-17811_Rev00_neuaufbau.pv P
 Flg Calc [Int P]: Channel Fla. Flng: 37 1:49am May 5,2022

Gasket Seating Bolt Load [Wm2]:
 $= y * b * pi * G + yPart * bPart * lp$
 $= 0.0 * 2.5 * pi * 165.0 + 0.0 * 0.0 * 0.0$
 $= 0.000 \text{ N}$

Required Bolt Area [Am]:
 $= \max(Wm1/Sb, Wm2/Sa)$
 $= \max(21381/172, 0/172)$
 $= 124.046 \text{ mm}^2$

ASME Maximum Circumferential Spacing between Bolts per App. 2 eq. (3) [Bsmax]:
 $= 2a + 6t / (m + 0.5)$
 $= 2 * 12.7 + 6 * 17.0 / (0.0 + 0.5)$
 $= 229.400 \text{ mm}$

Actual Circumferential Bolt Spacing [Bs]:
 $= C * \sin(pi / n)$
 $= 179.6 * \sin(pi / 4)$
 $= 126.996 \text{ mm}$

ASME Moment Multiplier for Bolt Spacing per App. 2 eq. (7) [Bsc]:
 $= \max(\text{sqrt}(Bs / (2a + t)), 1)$
 $= \max(\text{sqrt}(126.996 / (2 * 12.7 + 17.0)), 1)$
 $= 1.7307$

Bolting Information for TEMA Imperial Thread Series (Non Mandatory):

Distance Across Corners for Nuts		24.613	mm	
Circular Wrench End Diameter	a	38.100	mm	
		Minimum	Actual	Maximum
Bolt Area:		124.046	325.161	
Radial Distance between Hub and Bolts:		15.875	23.500	
Radial Distance between Bolts and Edge:		15.875	20.200	
Circ. Spacing between the Bolts:		31.750	126.996	229.400

Flange Design Bolt Load, Gasket Seating [W]:
 $= Sa(Am + Ab) / 2$
 $= 172.38(124.0462 + 325.1606) / 2$
 $= 38712.72 \text{ N}$

Gasket Load for the Operating Condition [HG]:
 $= Wm1 - H$
 $= 21381 - 21381$
 $= 0.00 \text{ N}$

Moment Arm Calculations:

Distance to Gasket Load Reaction [hg]:
 $= (C - G) / 2$
 $= (179.6 - 165.0) / 2$
 $= 7.3000 \text{ mm}$

Distance to Face Pressure Reaction [ht]:
 $= (R + g1 + hg) / 2$

Strength Calculation PV-Elite
 IWS-Monje Heat Exchangers GmbH
 Wittener Str. 102, 44789 Bochum, Germany
 PV Elite 24 Licensee: IWS-Monj? Heat Exchangers GmbH
 FileName : BK12-3103-L1200_Airpack-17811_Rev00_neuaufbau.pv P
 Flg Calc [Int P]: Channel Fla. Flng: 37 1:49am May 5,2022

$$= (22.5 + 0.0 + 7.3)/2$$

$$= 14.9000 \text{ mm}$$

Distance to End Pressure Reaction [hd]:

$$= R + (g1 / 2)$$

$$= 22.5 +(0.0/2.0)$$

$$= 22.5000 \text{ mm}$$

Summary of Moments for Internal Pressure: (N-mm)

Loading	Force	Distance	Bolt Corr	Moment
End Pressure, Md	14228.	22.5000	1.7307	554261.
Face Pressure, Mt	7153.	14.9000	1.7307	184520.
Gasket Load, Mg	0.	7.3000	1.7307	0.
Gasket Seating, Matm	38713.	7.3000	1.7307	489289.

Total Moment for Operation, Mop 738781. N-mm
 Total Moment for Gasket seating, Matm 489289. N-mm

Effective Hub Length, ho = sqrt(Bcor*goCor) 0.000 mm
 Hub Ratio, h/h0 = Defined as 0 0.000
 Thickness Ratio, g1/g0 = Defined as 0.0 0.000
 Factors from Figure 2-7.1
 K = 1.634
 U = 4.535
 Z = 2.197
 T = 1.653
 Y = 4.126

Tangential Flange Stress, Operating [Sto]:

$$= (Y * Mop)/(t^2 * Bcor)$$

$$= (4.1264*738781)/(17.0^2*134.6)$$

$$= 78.34 \text{ MPa}$$

Tangential Flange Stress, Seating [STa]:

$$= (Y * Matm)/(t^2 * Bcor)$$

$$= (4.1264*489289)/(17.0^2*134.6)$$

$$= 51.89 \text{ MPa}$$

Bolt Stress, Operating [BSo]:

$$= Wm1 / Ab$$

$$= 21381/325.1606$$

$$= 65.76 \text{ MPa}$$

Bolt Stress, Seating [BSa]:

$$= (Wm2 / Ab)$$

$$= (0/325.1606)$$

$$= 0.00 \text{ MPa}$$

Flange Stress Analysis Results: MPa

	Actual	Operating Allowed	Gasket Seating Actual	Gasket Seating Allowed
Tangential Flange	78.34	137.90	51.89	137.90
Bolting	65.76	172.38	0.00	172.38

Minimum Required Flange Thickness 14.249 mm
 Estimated M.A.W.P. (Operating) 2 MPa

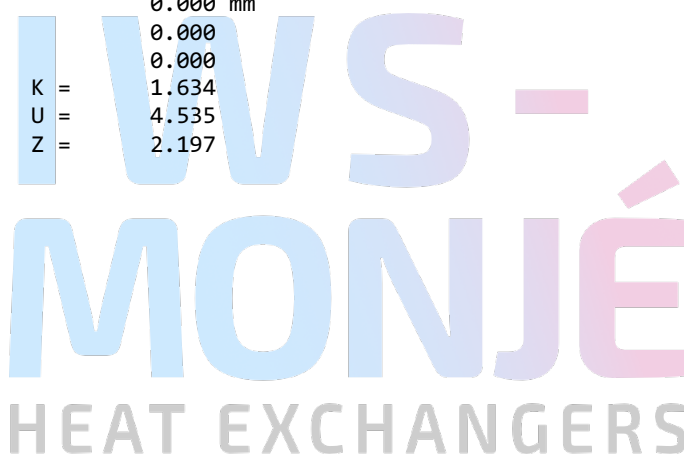

Strength Calculation PV-Elite
IWS-Monje Heat Exchangers GmbH
Wittener Str. 102, 44789 Bochum, Germany
PV Elite 24 Licensee: IWS-Monje Heat Exchangers GmbH
FileName : BK12-3103-L1200_Airpack-17811_Rev00_neuaufbau.pv P
Flg Calc [Int P]: Channel Fla. Flng: 37 1:49am May 5,2022

Estimated Finished Weight of Flange at given Thk. 3.4 kg
Estimated Unfinished Weight of Forging at given Thk 3.4 kg

Required Fillet Weld Leg size for Slip on Flanges:

= max(tn, (6 mm or 1/4 inch)) no hub size given
= max(12.0, 6.0)
= 12.000 mm

PV Elite is a trademark of Hexagon AB, 2022, All rights reserved.

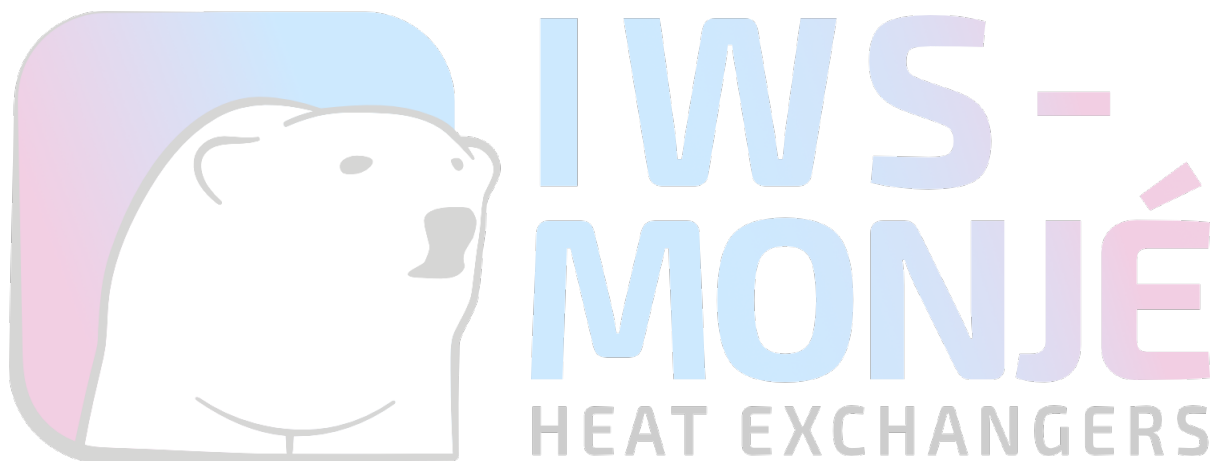

Strength Calculation PV-Elite
 IWS-Monje Heat Exchangers GmbH
 Wittener Str. 102, 44789 Bochum, Germany
 PV Elite 24 Licensee: IWS-Monje? Heat Exchangers GmbH
 FileName : BK12-3103-L1200_Airpack-17811_Rev00_neuaufbau.pv P
 Flg Calc [Int P]: Shell Fl. 1 Flng: 38 1:49am May 5,2022

Flange Input Data Values

Description: Shell Fl. 1 :

Shell flange ring 1

Flange Type	Integral Weld Neck		
Design Pressure	P	1.00	MPa
Design Temperature		210	°C
Internal Corrosion Allowance	ci	0.0000	mm
External Corrosion Allowance	ce	0.0000	mm
Use Corrosion Allowance in Thickness Calcs.		Yes	
Flange Inside Diameter	B	133.000	mm
Flange Outside Diameter	A	220.000	mm
Flange Thickness	t	18.0000	mm
Thickness of Hub at Small End	go	3.4000	mm
Thickness of Hub at Large End	g1	4.5000	mm
Length of Hub	h	18.0000	mm
Flange Material		SA-182 F316	
Flange Material UNS number		S31600	
Flange Allowable Stress At Temperature	Sfo	131.56	MPa
Flange Allowable Stress At Ambient	Sfa	137.90	MPa
Bolt Material		SA-193 B7	
Bolt Allowable Stress At Temperature	Sb	172.38	MPa
Bolt Allowable Stress At Ambient	Sa	172.38	MPa
Diameter of Bolt Circle	C	179.600	mm
Nominal Bolt Diameter	a	12.0000	mm
Type of Threads		TEMA Thread Series	
Number of Bolts		4	
Flange Face Outside Diameter	Fod	165.000	mm
Flange Face Inside Diameter	Fid	155.000	mm
Flange Facing Sketch		1, Code Sketch 1a	
Gasket Outside Diameter	Go	165.000	mm
Gasket Inside Diameter	Gi	155.000	mm
Gasket Factor	m	0.0000	
Gasket Design Seating Stress	y	0.00	MPa
Column for Gasket Seating		2, Code Column II	
Gasket Thickness	tg	2.0000	mm

Strength Calculation PV-Elite
 IWS-Monje Heat Exchangers GmbH
 Wittener Str. 102, 44789 Bochum, Germany
 PV Elite 24 Licensee: IWS-Monje? Heat Exchangers GmbH
 FileName : BK12-3103-L1200_Airpack-17811_Rev00_neuaufbau.pv P
 Flg Calc [Int P]: Shell Fl. 1 Flng: 38 1:49am May 5,2022

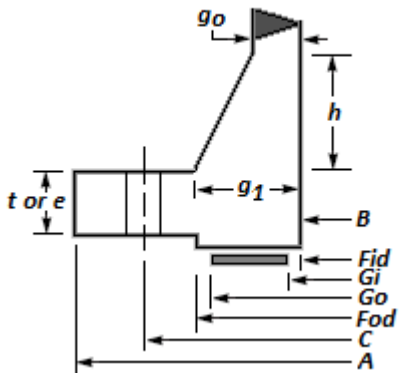

ASME Code, Section VIII Division 1, 2021

Hub Small End Required Thickness due to Internal Pressure:

$$= (P \cdot (D/2 + C_a)) / (S \cdot E - 0.6 \cdot P) \text{ per UG-27 (c)(1)}$$

$$= (1. \cdot (133.0/2 + 0.0)) / (131.56 \cdot 1.0 - 0.6 \cdot 1.0) + C_a$$

$$= 0.5078 \text{ mm}$$

Hub Small End Hub MAWP:

$$= (S \cdot E \cdot t) / (R + 0.6 \cdot t) \text{ per UG-27 (c)(1)}$$

$$= (131.56 \cdot 1.0 \cdot 3.4) / (66.5 + 0.6 \cdot 3.4)$$

$$= 6.526 \text{ MPa}$$

Corroded Flange ID,	$B_{cor} = B + 2 \cdot F_{cor}$	133.000 mm
Corroded Large Hub,	$g1_{cor} = g1 - c_i$	4.500 mm
Corroded Small Hub,	$g0_{cor} = g0 - c_i$	3.400 mm
Code R Dimension,	$R = (C - B) / 2 - g1$	18.800 mm
Gasket Contact Width,	$N = (G_o - G_i) / 2$	5.000 mm
Basic Gasket Width,	$b_o = N / 2$	2.500 mm
Effective Gasket Width,	$b = b_o$	2.500 mm
Gasket Reaction Diameter,	$G = G_o$ (Self-Energizing)	165.000 mm

Basic Flange and Bolt Loads:

Hydrostatic End Load due to Pressure [H]:

$$= 0.785 \cdot G^2 \cdot P_{eq}$$

$$= 0.785 \cdot 165.0^2 \cdot 1.$$

$$= 21380.648 \text{ N}$$

Contact Load on Gasket Surfaces [Hp]:

$$= 2 \cdot b \cdot \pi \cdot G \cdot m \cdot P$$

$$= 2 \cdot 2.5 \cdot \pi \cdot 165.0 \cdot 0.0 \cdot 1.$$

$$= 0.000 \text{ N}$$

Hydrostatic End Load at Flange ID [Hd]:

$$= \pi \cdot B_{cor}^2 \cdot P / 4$$

$$= \pi \cdot 133.0^2 \cdot 1. / 4$$

$$= 13891.725 \text{ N}$$

Strength Calculation PV-Elite
 IWS-Monje Heat Exchangers GmbH
 Wittener Str. 102, 44789 Bochum, Germany
 PV Elite 24 Licensee: IWS-Monje? Heat Exchangers GmbH
 FileName : BK12-3103-L1200_Airpack-17811_Rev00_neuaufbau.pv P
 Flg Calc [Int P]: Shell Fl. 1 Flng: 38 1:49am May 5,2022

Pressure Force on Flange Face [Ht]:

$$= H - H_d$$

$$= 21381 - 13892$$

$$= 7488.922 \text{ N}$$

Operating Bolt Load [Wm1]:

$$= \max(H + H_p + H'p, 0)$$

$$= \max(21381 + 0 + 0, 0)$$

$$= 21380.648 \text{ N}$$

Gasket Seating Bolt Load [Wm2]:

$$= y * b * \pi * G + y_{Part} * b_{Part} * l_p$$

$$= 0.0 * 2.5 * \pi * 165.0 + 0.0 * 0.0 * 0.0$$

$$= 0.000 \text{ N}$$

Required Bolt Area [Am]:

$$= \max(Wm1/S_b, Wm2/S_a)$$

$$= \max(21381/172, 0/172)$$

$$= 124.046 \text{ mm}^2$$

ASME Maximum Circumferential Spacing between Bolts per App. 2 eq. (3) [Bsmax]:

$$= 2a + 6t / (m + 0.5)$$

$$= 2 * 12.7 + 6 * 18.0 / (0.0 + 0.5)$$

$$= 241.400 \text{ mm}$$

Actual Circumferential Bolt Spacing [Bs]:

$$= C * \sin(\pi / n)$$

$$= 179.6 * \sin(\pi / 4)$$

$$= 126.996 \text{ mm}$$

ASME Moment Multiplier for Bolt Spacing per App. 2 eq. (7) [Bsc]:

$$= \max(\sqrt{ Bs / (2a + t) }, 1)$$

$$= \max(\sqrt{ 126.996 / (2 * 12.7 + 18.0) }, 1)$$

$$= 1.7106$$

Bolting Information for TEMA Imperial Thread Series (Non Mandatory):

	Minimum	Actual	Maximum
Bolt Area:	124.046	325.161	
Radial Distance between Hub and Bolts:	20.637	18.800	
Radial Distance between Bolts and Edge:	15.875	20.200	
Circ. Spacing between the Bolts:	31.750	126.996	241.400

Flange Design Bolt Load, Gasket Seating [W]:

$$= S_a (A_m + A_b) / 2$$

$$= 172.38 (124.0462 + 325.1606) / 2$$

$$= 38712.72 \text{ N}$$

Gasket Load for the Operating Condition [HG]:

$$= Wm1 - H$$

$$= 21381 - 21381$$

$$= 0.00 \text{ N}$$

Moment Arm Calculations:

Strength Calculation PV-Elite
 IWS-Monje Heat Exchangers GmbH
 Wittener Str. 102, 44789 Bochum, Germany
 PV Elite 24 Licensee: IWS-Monje? Heat Exchangers GmbH
 FileName : BK12-3103-L1200_Airpack-17811_Rev00_neuaufbau.pv P
 Flg Calc [Int P]: Shell Fl. 1 Flng: 38 1:49am May 5,2022

Distance to Gasket Load Reaction [hg]:

$$= (C - G) / 2$$

$$= (179.6 - 165.0) / 2$$

$$= 7.3000 \text{ mm}$$

Distance to Face Pressure Reaction [ht]:

$$= (R + g1 + hg) / 2$$

$$= (18.8 + 4.5 + 7.3) / 2$$

$$= 15.3000 \text{ mm}$$

Distance to End Pressure Reaction [hd]:

$$= R + (g1 / 2)$$

$$= 18.8 + (4.5 / 2)$$

$$= 21.0500 \text{ mm}$$

Summary of Moments for Internal Pressure: (N-mm)

Loading	Force	Distance	Bolt Corr	Moment
End Pressure, Md	13892.	21.0500	1.7106	500421.
Face Pressure, Mt	7489.	15.3000	1.7106	196082.
Gasket Load, Mg	0.	7.3000	1.7106	0.
Gasket Seating, Matm	38713.	7.3000	1.7106	483619.
Total Moment for Operation, Mop				696503. N-mm
Total Moment for Gasket seating, Matm				483619. N-mm
Effective Hub Length, ho = sqrt(Bcor*goCor)			21.265 mm	
Hub Ratio, h/h0 = HL / H0			0.846	
Thickness Ratio, g1/g0 = (g1Cor/goCor)			1.324	
Flange Factors for Integral Flange:				
Factor F			0.835	
Factor V			0.330	
Factor f			1.000	
Factors from Figure 2-7.1				
T =	1.645		K =	1.654
Y =	4.032		U =	4.431
e =	0.0393 1/mm		Z =	2.152
			d =	3305.564 mm ³
Stress Factors				
Beta =	1.942		Alpha =	1.707
Delta =	1.764		Gamma =	1.038
			Lambda =	2.802

Longitudinal Hub Stress, Operating [SHo]:

$$= (f * Mop / Bcor) / (L * g1^2)$$

$$= (1.0 * 696503 / 133.0) / (2.8021 * 4.5^2)$$

$$= 92.26 \text{ MPa}$$

Longitudinal Hub Stress, Seating [SHa]:

$$= (f * Matm / Bcor) / (L * g1^2)$$

$$= (1.0 * 483619 / 133.0) / (2.8021 * 4.5^2)$$

$$= 64.06 \text{ MPa}$$

Radial Flange Stress, Operating [SRo]:

$$= (beta * Mop / Bcor) / (L * t^2)$$

$$= (1.9424 * 696503 / 133.0) / (2.8021 * 18.0^2)$$

$$= 11.20 \text{ MPa}$$

Strength Calculation PV-Elite
 IWS-Monje Heat Exchangers GmbH
 Wittener Str. 102, 44789 Bochum, Germany
 PV Elite 24 Licensee: IWS-Monje? Heat Exchangers GmbH
 FileName : BK12-3103-L1200_Airpack-17811_Rev00_neuaufbau.pv P
 Flg Calc [Int P]: Shell Fl. 1 Flng: 38 1:49am May 5,2022

Radial Flange Stress, Seating [SRa]:

$$= (\text{beta} * \text{Matm}/\text{Bcor}) / (\text{L} * \text{t}^2)$$

$$= (1.9424*483619/133.0) / (2.8021*18.0^2)$$

$$= 7.78 \text{ MPa}$$

Tangential Flange Stress, Operating [STo]:

$$= (\text{Y} * \text{Mo} / (\text{t}^2 * \text{Bcor})) - \text{Z} * \text{SRo}$$

$$= (4.0324*696503 / (18.0^2 * 133.0)) - 2.152 * 11$$

$$= 41.05 \text{ MPa}$$

Tangential Flange Stress, Seating [STa]:

$$= (\text{y} * \text{Matm} / (\text{t}^2 * \text{Bcor})) - \text{Z} * \text{SRa}$$

$$= (4.0324*483619 / (18.0^2 * 133.0)) - 2.152 * 8$$

$$= 28.50 \text{ MPa}$$

Average Flange Stress, Operating [SAo]:

$$= (\text{SHo} + \max(\text{SRo}, \text{STo})) / 2$$

$$= (92 + \max(11, 41)) / 2$$

$$= 66.66 \text{ MPa}$$

Average Flange Stress, Seating [SAa]:

$$= (\text{SHa} + \max(\text{SRa}, \text{STa})) / 2$$

$$= (64 + \max(8, 29)) / 2$$

$$= 46.28 \text{ MPa}$$

Bolt Stress, Operating [BSo]:

$$= \text{Wm1} / \text{Ab}$$

$$= 21381 / 325.1606$$

$$= 65.76 \text{ MPa}$$

Bolt Stress, Seating [BSa]:

$$= (\text{Wm2} / \text{Ab})$$

$$= (0 / 325.1606)$$

$$= 0.00 \text{ MPa}$$

Flange Stress Analysis Results: MPa

	Operating		Gasket Seating	
	Actual	Allowed	Actual	Allowed
Longitudinal Hub	92.26	197.34	64.06	206.85
Radial Flange	11.20	131.56	7.78	137.90
Tangential Flange	41.05	131.56	28.50	137.90
Maximum Average	66.66	131.56	46.28	137.90
Bolting	65.76	172.38	0.00	172.38

Minimum Required Flange Thickness	12.141 mm
Estimated M.A.W.P. (Operating)	2 MPa
Estimated Finished Weight of Flange at given Thk.	3.7 kg
Estimated Unfinished Weight of Forging at given Thk	7.0 kg

SA-182 F316, Min Metal Temp without impact per UHA-51: -196 °C

PV Elite is a trademark of Hexagon AB, 2022, All rights reserved.

Strength Calculation PV-Elite
 IWS-Monje Heat Exchangers GmbH
 Wittener Str. 102, 44789 Bochum, Germany
 PV Elite 24 Licensee: IWS-Monje? Heat Exchangers GmbH
 FileName : BK12-3103-L1200_Airpack-17811_Rev00_neuaufbau.pv P
 Flg Calc [Int P]: Shell Fl. 2 Flng: 39 1:49am May 5,2022

Flange Input Data Values

Description: Shell Fl. 2 :

Shell flange ring 2

Flange Type	Integral Weld Neck		
Design Pressure	P	1.00	MPa
Design Temperature		210	°C
Internal Corrosion Allowance	ci	0.0000	mm
External Corrosion Allowance	ce	0.0000	mm
Use Corrosion Allowance in Thickness Calcs.		Yes	
Flange Inside Diameter	B	133.000	mm
Flange Outside Diameter	A	220.000	mm
Flange Thickness	t	18.0000	mm
Thickness of Hub at Small End	go	3.4000	mm
Thickness of Hub at Large End	g1	4.5000	mm
Length of Hub	h	18.0000	mm
Flange Material		SA-182 F316	
Flange Material UNS number		S31600	
Flange Allowable Stress At Temperature	Sfo	131.60	MPa
Flange Allowable Stress At Ambient	Sfa	137.90	MPa
Bolt Material		SA-193 B7	
Bolt Allowable Stress At Temperature	Sb	172.38	MPa
Bolt Allowable Stress At Ambient	Sa	172.38	MPa
Diameter of Bolt Circle	C	179.600	mm
Nominal Bolt Diameter	a	12.0000	mm
Type of Threads		TEMA Thread Series	
Number of Bolts		4	
Flange Face Outside Diameter	Fod	165.000	mm
Flange Face Inside Diameter	Fid	155.000	mm
Flange Facing Sketch		1, Code Sketch 1a	
Gasket Outside Diameter	Go	165.000	mm
Gasket Inside Diameter	Gi	155.000	mm
Gasket Factor	m	0.0000	
Gasket Design Seating Stress	y	0.00	MPa
Column for Gasket Seating		2, Code Column II	
Gasket Thickness	tg	2.0000	mm

Strength Calculation PV-Elite
 IWS-Monje Heat Exchangers GmbH
 Wittener Str. 102, 44789 Bochum, Germany
 PV Elite 24 Licensee: IWS-Monje? Heat Exchangers GmbH
 FileName : BK12-3103-L1200_Airpack-17811_Rev00_neuaufbau.pv P
 Flg Calc [Int P]: Shell Fl. 2 Flng: 39 1:49am May 5,2022

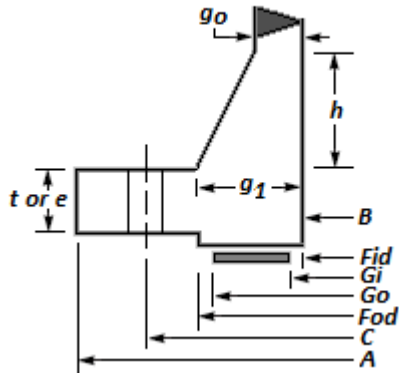

ASME Code, Section VIII Division 1, 2021

Hub Small End Required Thickness due to Internal Pressure:

$$\begin{aligned}
 &= (P \cdot (D/2 + Ca)) / (S \cdot E - 0.6 \cdot P) \text{ per UG-27 (c)(1)} \\
 &= (1. \cdot (133.0 / 2 + 0.0)) / (131.6 \cdot 1.0 - 0.6 \cdot 1.) + Ca \\
 &= 0.5076 \text{ mm}
 \end{aligned}$$

Hub Small End Hub MAWP:

$$\begin{aligned}
 &= (S \cdot E \cdot t) / (R + 0.6 \cdot t) \text{ per UG-27 (c)(1)} \\
 &= (131.6 \cdot 1.0 \cdot 3.4) / (66.5 + 0.6 \cdot 3.4) \\
 &= 6.528 \text{ MPa}
 \end{aligned}$$

Corroded Flange ID,	Bcor = B + 2 * Fcor	133.000 mm
Corroded Large Hub,	g1Cor = g1 - ci	4.500 mm
Corroded Small Hub,	g0Cor = go - ci	3.400 mm
Code R Dimension,	R = (C - B) / 2 - g1	18.800 mm
Gasket Contact Width,	N = (Go - Gi) / 2	5.000 mm
Basic Gasket Width,	bo = N / 2	2.500 mm
Effective Gasket Width,	b = bo	2.500 mm
Gasket Reaction Diameter,	G = Go (Self-Energizing)	165.000 mm

Basic Flange and Bolt Loads:

Hydrostatic End Load due to Pressure [H]:

$$\begin{aligned}
 &= 0.785 \cdot G^2 \cdot Peq \\
 &= 0.785 \cdot 165.0^2 \cdot 1. \\
 &= 21380.648 \text{ N}
 \end{aligned}$$

Contact Load on Gasket Surfaces [Hp]:

$$\begin{aligned}
 &= 2 \cdot b \cdot \pi \cdot G \cdot m \cdot P \\
 &= 2 \cdot 2.5 \cdot \pi \cdot 165.0 \cdot 0.0 \cdot 1. \\
 &= 0.000 \text{ N}
 \end{aligned}$$

Hydrostatic End Load at Flange ID [Hd]:

$$\begin{aligned}
 &= \pi \cdot Bcor^2 \cdot P / 4 \\
 &= \pi \cdot 133.0^2 \cdot 1. / 4 \\
 &= 13891.725 \text{ N}
 \end{aligned}$$

Strength Calculation PV-Elite
IWS-Monje Heat Exchangers GmbH
Wittener Str. 102, 44789 Bochum, Germany
PV Elite 24 Licensee: IWS-Monje? Heat Exchangers GmbH
FileName : BK12-3103-L1200_Airpack-17811_Rev00_neuaufbau.pv P
Flg Calc [Int P]: Shell Fl. 2 Flng: 39 1:49am May 5,2022

Pressure Force on Flange Face [Ht]:

$$\begin{aligned}
 &= H - H_d \\
 &= 21381 - 13892 \\
 &= 7488.922 \text{ N}
 \end{aligned}$$

Operating Bolt Load [Wm1]:

$$\begin{aligned}
 &= \max(H + H_p + H'p, 0) \\
 &= \max(21381 + 0 + 0, 0) \\
 &= 21380.648 \text{ N}
 \end{aligned}$$

Gasket Seating Bolt Load [Wm2]:

$$\begin{aligned}
 &= y * b * \pi * G + y_{Part} * b_{Part} * l_p \\
 &= 0.0 * 2.5 * \pi * 165.0 + 0.0 * 0.0 * 0.0 \\
 &= 0.000 \text{ N}
 \end{aligned}$$

Required Bolt Area [Am]:

$$\begin{aligned}
 &= \max(Wm1/S_b, Wm2/S_a) \\
 &= \max(21381/172, 0/172) \\
 &= 124.046 \text{ mm}^2
 \end{aligned}$$

ASME Maximum Circumferential Spacing between Bolts per App. 2 eq. (3) [Bsmax]:

$$\begin{aligned}
 &= 2a + 6t / (m + 0.5) \\
 &= 2 * 12.7 + 6 * 18.0 / (0.0 + 0.5) \\
 &= 241.400 \text{ mm}
 \end{aligned}$$

Actual Circumferential Bolt Spacing [Bs]:

$$\begin{aligned}
 &= C * \sin(\pi / n) \\
 &= 179.6 * \sin(\pi / 4) \\
 &= 126.996 \text{ mm}
 \end{aligned}$$

ASME Moment Multiplier for Bolt Spacing per App. 2 eq. (7) [Bsc]:

$$\begin{aligned}
 &= \max(\sqrt{ Bs / (2a + t) }, 1) \\
 &= \max(\sqrt{ 126.996 / (2 * 12.7 + 18.0) }, 1) \\
 &= 1.7106
 \end{aligned}$$

Bolting Information for TEMA Imperial Thread Series (Non Mandatory):

	Minimum	Actual	Maximum
Bolt Area:	124.046	325.161	
Radial Distance between Hub and Bolts:	20.637	18.800	
Radial Distance between Bolts and Edge:	15.875	20.200	
Circ. Spacing between the Bolts:	31.750	126.996	241.400

Flange Design Bolt Load, Gasket Seating [W]:

$$\begin{aligned}
 &= S_a (A_m + A_b) / 2 \\
 &= 172.38 (124.0462 + 325.1606) / 2 \\
 &= 38712.72 \text{ N}
 \end{aligned}$$

Gasket Load for the Operating Condition [HG]:

$$\begin{aligned}
 &= Wm1 - H \\
 &= 21381 - 21381 \\
 &= 0.00 \text{ N}
 \end{aligned}$$

Moment Arm Calculations:

Strength Calculation PV-Elite
 IWS-Monje Heat Exchangers GmbH
 Wittener Str. 102, 44789 Bochum, Germany
 PV Elite 24 Licensee: IWS-Monje? Heat Exchangers GmbH
 FileName : BK12-3103-L1200_Airpack-17811_Rev00_neuaufbau.pv P
 Flg Calc [Int P]: Shell Fl. 2 Flng: 39 1:49am May 5,2022

Distance to Gasket Load Reaction [hg]:

$$= (C - G) / 2$$

$$= (179.6 - 165.0) / 2$$

$$= 7.3000 \text{ mm}$$

Distance to Face Pressure Reaction [ht]:

$$= (R + g1 + hg) / 2$$

$$= (18.8 + 4.5 + 7.3) / 2$$

$$= 15.3000 \text{ mm}$$

Distance to End Pressure Reaction [hd]:

$$= R + (g1 / 2)$$

$$= 18.8 + (4.5 / 2)$$

$$= 21.0500 \text{ mm}$$

Summary of Moments for Internal Pressure: (N-mm)

Loading	Force	Distance	Bolt Corr	Moment
End Pressure, Md	13892.	21.0500	1.7106	500421.
Face Pressure, Mt	7489.	15.3000	1.7106	196082.
Gasket Load, Mg	0.	7.3000	1.7106	0.
Gasket Seating, Matm	38713.	7.3000	1.7106	483619.
Total Moment for Operation, Mop				696503. N-mm
Total Moment for Gasket seating, Matm				483619. N-mm
Effective Hub Length, ho = sqrt(Bcor*goCor)			21.265 mm	
Hub Ratio, h/h0 = HL / H0			0.846	
Thickness Ratio, g1/g0 = (g1Cor/goCor)			1.324	
Flange Factors for Integral Flange:				
Factor F			0.835	
Factor V			0.330	
Factor f			1.000	
Factors from Figure 2-7.1				
T =	1.645		K =	1.654
Y =	4.032		U =	4.431
e =	0.0393 1/mm		Z =	2.152
			d =	3305.564 mm ³
Stress Factors				
Beta =	1.942		Alpha =	1.707
Delta =	1.764		Gamma =	1.038
			Lambda =	2.802

Longitudinal Hub Stress, Operating [SHo]:

$$= (f * Mop / Bcor) / (L * g1^2)$$

$$= (1.0 * 696503 / 133.0) / (2.8021 * 4.5^2)$$

$$= 92.26 \text{ MPa}$$

Longitudinal Hub Stress, Seating [SHa]:

$$= (f * Matm / Bcor) / (L * g1^2)$$

$$= (1.0 * 483619 / 133.0) / (2.8021 * 4.5^2)$$

$$= 64.06 \text{ MPa}$$

Radial Flange Stress, Operating [SRo]:

$$= (beta * Mop / Bcor) / (L * t^2)$$

$$= (1.9424 * 696503 / 133.0) / (2.8021 * 18.0^2)$$

$$= 11.20 \text{ MPa}$$

Strength Calculation PV-Elite
 IWS-Monje Heat Exchangers GmbH
 Wittener Str. 102, 44789 Bochum, Germany
 PV Elite 24 Licensee: IWS-Monje? Heat Exchangers GmbH
 FileName : BK12-3103-L1200_Airpack-17811_Rev00_neuaufbau.pv P
 Flg Calc [Int P]: Shell Fl. 2 Flng: 39 1:49am May 5,2022

Radial Flange Stress, Seating [SRa]:

$$= (\text{beta} * \text{Matm}/\text{Bcor}) / (\text{L} * \text{t}^2)$$

$$= (1.9424*483619/133.0) / (2.8021*18.0^2)$$

$$= 7.78 \text{ MPa}$$

Tangential Flange Stress, Operating [STo]:

$$= (\text{Y} * \text{Mo} / (\text{t}^2 * \text{Bcor})) - \text{Z} * \text{SRo}$$

$$= (4.0324*696503 / (18.0^2 * 133.0)) - 2.152 * 11$$

$$= 41.05 \text{ MPa}$$

Tangential Flange Stress, Seating [STa]:

$$= (\text{y} * \text{Matm} / (\text{t}^2 * \text{Bcor})) - \text{Z} * \text{SRa}$$

$$= (4.0324*483619 / (18.0^2 * 133.0)) - 2.152 * 8$$

$$= 28.50 \text{ MPa}$$

Average Flange Stress, Operating [SAo]:

$$= (\text{SHo} + \max(\text{SRo}, \text{STo})) / 2$$

$$= (92 + \max(11, 41)) / 2$$

$$= 66.66 \text{ MPa}$$

Average Flange Stress, Seating [SAa]:

$$= (\text{SHa} + \max(\text{SRa}, \text{STa})) / 2$$

$$= (64 + \max(8, 29)) / 2$$

$$= 46.28 \text{ MPa}$$

Bolt Stress, Operating [BSo]:

$$= \text{Wm1} / \text{Ab}$$

$$= 21381 / 325.1606$$

$$= 65.76 \text{ MPa}$$

Bolt Stress, Seating [BSa]:

$$= (\text{Wm2} / \text{Ab})$$

$$= (0 / 325.1606)$$

$$= 0.00 \text{ MPa}$$

Flange Stress Analysis Results: MPa

	Operating		Gasket Seating	
	Actual	Allowed	Actual	Allowed
Longitudinal Hub	92.26	197.40	64.06	206.85
Radial Flange	11.20	131.60	7.78	137.90
Tangential Flange	41.05	131.60	28.50	137.90
Maximum Average	66.66	131.60	46.28	137.90
Bolting	65.76	172.38	0.00	172.38

Minimum Required Flange Thickness	12.141 mm
Estimated M.A.W.P. (Operating)	2 MPa
Estimated Finished Weight of Flange at given Thk.	3.7 kg
Estimated Unfinished Weight of Forging at given Thk	7.0 kg

SA-182 F316, Min Metal Temp without impact per UHA-51: -196 °C

PV Elite is a trademark of Hexagon AB, 2022, All rights reserved.

Strength Calculation PV-Elite
 IWS-Monje Heat Exchangers GmbH
 Wittener Str. 102, 44789 Bochum, Germany
 PV Elite 24 Licensee: IWS-Monje? Heat Exchangers GmbH
 FileName : BK12-3103-L1200_Airpack-17811_Rev00_neuaufbau.pv P
 Flg Calc [Int P]: Cover head Flng: 40 1:49am May 5,2022

Flange Input Data Values

Description: Cover head :

Cover head

Flange Type		Blind	
Design Pressure	P	1.00	MPa
Design Temperature		95	°C
Internal Corrosion Allowance	ci	1.0000	mm
External Corrosion Allowance	ce	0.0000	mm
Use Corrosion Allowance in Thickness Calcs.		Yes	
Flange Outside Diameter	A	220.000	mm
Flange Thickness	t	25.0000	mm
Flange Material		SA-516 70	
Flange Material UNS number		K02700	
Flange Allowable Stress At Temperature	Sfo	137.90	MPa
Flange Allowable Stress At Ambient	Sfa	137.90	MPa
Bolt Material		SA-193 B7	
Bolt Allowable Stress At Temperature	Sb	172.38	MPa
Bolt Allowable Stress At Ambient	Sa	172.38	MPa
Diameter of the Load Reaction, Long Span	D	0.000	mm
Diameter of the Load Reaction, Short Span	d	0.000	mm
Perimeter along the Center of the Bolts	L	564.230	mm
Diameter of Bolt Circle	C	179.600	mm
Nominal Bolt Diameter	a	12.0000	mm
Type of Threads		TEMA Thread Series	
Number of Bolts		4	
Flange Face Outside Diameter	Fod	165.000	mm
Flange Face Inside Diameter	Fid	155.000	mm
Flange Facing Sketch		1, Code Sketch 1a	
Gasket Outside Diameter	Go	165.000	mm
Gasket Inside Diameter	Gi	155.000	mm
Gasket Factor	m	0.0000	
Gasket Design Seating Stress	y	0.00	MPa
Column for Gasket Seating		2, Code Column II	
Gasket Thickness	tg	2.0000	mm

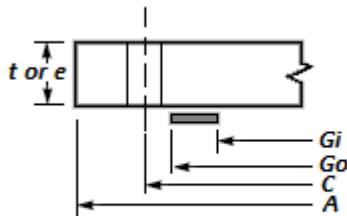

Strength Calculation PV-Elite
 IWS-Monje Heat Exchangers GmbH
 Wittener Str. 102, 44789 Bochum, Germany
 PV Elite 24 Licensee: IWS-Monje? Heat Exchangers GmbH
 FileName : BK12-3103-L1200_Airpack-17811_Rev00_neuaufbau.pv P
 Flg Calc [Int P]: Cover head Flng: 40 1:49am May 5,2022

ASME Code, Section VIII Division 1, 2021

Gasket Contact Width, $N = (G_o - G_i) / 2$ 5.000 mm
 Basic Gasket Width, $b_o = N / 2$ 2.500 mm
 Effective Gasket Width, $b = b_o$ 2.500 mm
 Gasket Reaction Diameter, $G = G_o$ (Self-Energizing) 165.000 mm

Basic Flange and Bolt Loads:

Hydrostatic End Load due to Pressure [H]:

$$= 0.785 * G^2 * P_{eq}$$

$$= 0.785 * 165.0^2 * 1.$$

$$= 21380.648 \text{ N}$$

Contact Load on Gasket Surfaces [Hp]:

$$= 2 * b * \pi * G * m * P$$

$$= 2 * 2.5 * \pi * 165.0 * 0.0 * 1.$$

$$= 0.000 \text{ N}$$

Operating Bolt Load [Wm1]:

$$= \max(H + H_p + H'p, 0)$$

$$= \max(21381 + 0 + 0, 0)$$

$$= 21380.648 \text{ N}$$

Gasket Seating Bolt Load [Wm2]:

$$= y * b * \pi * G + y_{Part} * b_{Part} * l_p$$

$$= 0.0 * 2.5 * \pi * 165.0 + 0.0 * 0.0 * 0.0$$

$$= 0.000 \text{ N}$$

Required Bolt Area [Am]:

$$= \max(W_{m1}/S_b, W_{m2}/S_a)$$

$$= \max(21381/172, 0/172)$$

$$= 124.046 \text{ mm}^2$$

ASME Maximum Circumferential Spacing between Bolts per App. 2 eq. (3) [Bsmax]:

$$= 2a + 6t/(m + 0.5)$$

$$= 2 * 12.7 + 6 * 24.0/(0.0 + 0.5)$$

$$= 313.400 \text{ mm}$$

Actual Circumferential Bolt Spacing [Bs]:

$$= C * \sin(\pi / n)$$

$$= 179.6 * \sin(\pi / 4)$$

$$= 126.996 \text{ mm}$$

ASME Moment Multiplier for Bolt Spacing per App. 2 eq. (7) [Bsc]:

$$= \max(\sqrt{ Bs / (2a + t) }, 1)$$

$$= \max(\sqrt{ 126.996 / (2 * 12.7 + 24.0) }, 1)$$

$$= 1.6034$$

Bolting Information for TEMA Imperial Thread Series (Non Mandatory):

	Minimum	Actual	Maximum
Bolt Area:	124.046	325.161	
Radial Distance between Bolts and Edge:	15.875	20.200	
Circ. Spacing between the Bolts:	31.750	126.996	313.400

Strength Calculation PV-Elite
 IWS-Monje Heat Exchangers GmbH
 Wittener Str. 102, 44789 Bochum, Germany
 PV Elite 24 Licensee: IWS-Monje? Heat Exchangers GmbH
 FileName : BK12-3103-L1200_Airpack-17811_Rev00_neuaufbau.pv P
 Flg Calc [Int P]: Cover head Flng: 40 1:49am May 5,2022

Flange Design Bolt Load, Gasket Seating [W]:

$$= Sa(Am + Ab) / 2$$

$$= 172.38(124.0462 + 325.1606)/2$$

$$= 38712.72 \text{ N}$$

Gasket Load for the Operating Condition [HG]:

$$= Wm1$$

$$= 21380.65 \text{ N}$$

Moment Arm Calculations:

Distance to Gasket Load Reaction [hg]:

$$= (C - G) / 2$$

$$= (179.6 - 165.0)/2$$

$$= 7.3000 \text{ mm}$$

Tangential Flange Stress, Flat Head (UG-34), Operating [STo]:

$$= 1.9 * Wm1 * hg * Bsc / (t^2 * G) + C * Z * Peq * G^2 / t^2$$

$$= 1.9 * 21381 * 7.3 * 1.6034 / (24.0^2 * 165.0) + 0.3 * 1.0 * 1. * 165.0^2 / 24.0^2$$

$$= 19.18 \text{ MPa}$$

Tangential Flange Stress, Flat Head (UG-34), Seating [STa]:

$$= 1.9 * W * hg * Bsc / (t^2 * G)$$

$$= 1.9 * 38713 * 7.3 * 1.603 / (24.0^2 * 165.0)$$

$$= 9.06 \text{ MPa}$$

Bolt Stress, Operating [BSo]:

$$= Wm1 / Ab$$

$$= 21381 / 325.1606$$

$$= 65.76 \text{ MPa}$$

Bolt Stress, Seating [BSa]:

$$= (Wm2 / Ab)$$

$$= (0 / 325.1606)$$

$$= 0.00 \text{ MPa}$$

Flange Stress Analysis Results: MPa

	Actual	Operating Allowed	Actual	Gasket Seating Allowed
Tangential Flange	19.18	137.90	9.06	137.90
Bolting	65.76	172.38	0.00	172.38

Reqd. Blind Flange Thickness at Center	9.951 mm
Reqd. Blind Flange Thickness at Gasket	7.151 mm
Estimated M.A.W.P. (Operating)	3 MPa
Estimated Finished Weight of Flange at given Thk.	7.4 kg
Estimated Unfinished Weight of Forging at given Thk	7.4 kg

Minimum Design Metal Temperature Results:

Thickness Ratio = 0.381, Temperature Reduction per Fig. UCS 66.1 = 56 °C

Min Metal Temp. w/o impact per UCS-66, Curve B	-29 °C
Min Metal Temp. at Required thickness (UCS 66.1)	-48 °C

Strength Calculation PV-Elite
IWS-Monje Heat Exchangers GmbH
Wittener Str. 102, 44789 Bochum, Germany
PV Elite 24 Licensee: IWS-Monje Heat Exchangers GmbH
FileName : BK12-3103-L1200_Airpack-17811_Rev00_neuaufbau.pv P
Flg Calc [Int P]: Cover head Flng: 40 1:49am May 5,2022

PV Elite is a trademark of Hexagon AB, 2022, All rights reserved.

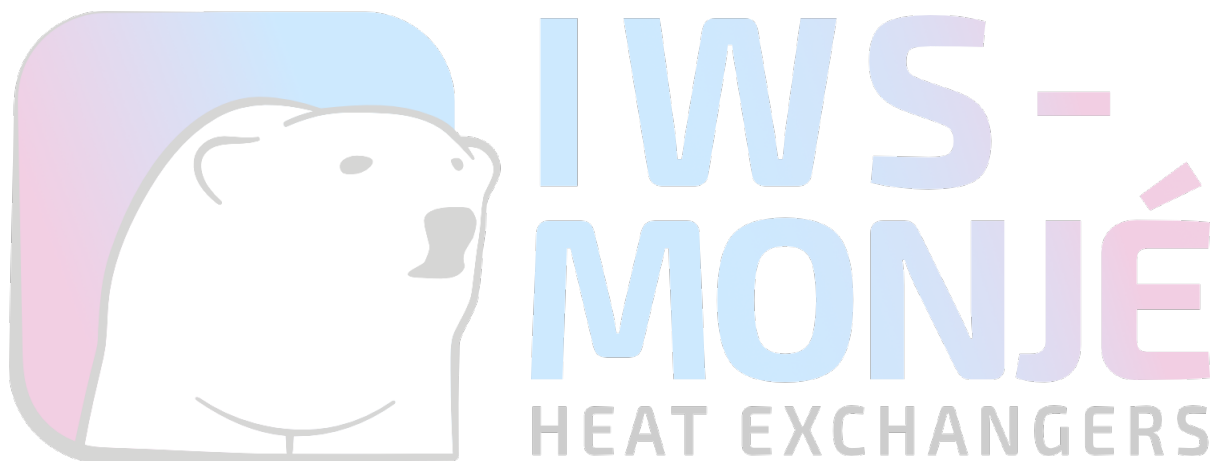

Strength Calculation PV-Elite
 IWS-Monje Heat Exchangers GmbH
 Wittener Str. 102, 44789 Bochum, Germany
 PV Elite 24 Licensee: IWS-Monje? Heat Exchangers GmbH
 FileName : BK12-3103-L1200_Airpack-17811_Rev00_neuaufbau.pv P
 Internal Pressure Calculations: Step: 7 1:49am May 5,2022

Internal Pressure Results Summary:

Element Thickness, Pressure, Diameter and Allowable Stress :

From	To	Int. Press + Liq. Hd MPa	Nominal Thickness mm	Total Corr Allowance mm	Element Diameter mm	Allowable Stress(SE) MPa
Channel head fla		1	27	1	160	137.9
Channel head cyl		1	13	1	160	137.9
Channel head fla		1	18	1	132.6	137.9
Shell flange rin		1	133	131.56
Main Shell		2.5	141.3	132.2
Shell flange rin		1	133	131.6
Cover head		1	...	1	220	137.9

Element Required Thickness and MAWP :

From	To	Design Pressure MPa	M.A.W.P. Corroded MPa	M.A.P. New & Cold MPa	Minimum Thickness mm	Required Thickness mm
Channel head fla		1	25.958	27.9932	27	6.10314
Channel head cyl		1	22.0053	23.9666	13	3.5
Channel head fla		1	1.76016	1.95811	18	14.2494
Shell flange rin		1	1.97362	2.06878	18	12.1412
Main Shell		2.5	6.48694	6.76663	3.4	1.5
Shell flange rin		1	1.97425	2.06878	18	12.1412
Cover head		1	2.62127	2.62127	25	9.95133

Summary of Heat Exchanger Maximum Allowable Working Pressures :

Note:
 For Exchanger designs, the following values include MAWPs that consider the tubesheet, tubes, tube/tubesheet joint etc. These values were determined by iteration. Review the tubesheet analysis report for more information.

Shell Side MAWP = 2 MPa
 Shell Side MAPnc = 2 MPa
 Channel Side MAWP = 1 MPa
 Channel Side MAPnc = 1 MPa

Elements Suitable for Design Internal Pressure.

Internal Pressure Calculation Results:

ASME Code, Section VIII Division 1, 2021

Welded Flat Head From 10 To 20 SA-516 70 , UCS-66 Crv. B at 95 °C

Channel head flat

Longitudinal Joint: User Defined

Strength Calculation PV-Elite
 IWS-Monje Heat Exchangers GmbH
 Wittener Str. 102, 44789 Bochum, Germany
 PV Elite 24 Licensee: IWS-Monje? Heat Exchangers GmbH
 FileName : BK12-3103-L1200_Airpack-17811_Rev00_neuaufbau.pv P
 Internal Pressure Calculations: Step: 7 1:49am May 5,2022

Material UNS Number: K02700

Required Thickness due to Internal Pressure [tr]:
 $= d * \sqrt{Z * C * P / (S * E)}$ per UG-34 (c)(3)
 $= 134.0 * \sqrt{1.0 * 0.2 * 1. / (137.9 * 1.0)}$
 $= 5.1031 + 1.0000 = 6.1031 \text{ mm}$

Max. Allowable Working Pressure at given Thickness, corroded [MAWP]:
 $= (t/d)^2 * ((S * E) / (C * Z))$ per UG-34 (c)(3)
 $= ((26.0) / 134.0)^2 * ((137.9 * 1.0) / (0.2 * 1.0))$
 $= 26 \text{ MPa}$

Maximum Allowable Pressure, New and Cold [MAPNC]:
 $= (t/d)^2 * ((S * E) / (C * Z))$ per UG-34 (c)(3)
 $= (27.0 / 134.0)^2 * ((137.9 * 1.0) / (0.2 * 1.0))$
 $= 28 \text{ MPa}$

Actual stress at given pressure and thickness, corroded [Sact]:
 $= (Z * C * P) / (((t/d)^2) * E)$
 $= (1.0 * 0.2 * 1.0) / (((26.0) / 134.0)^2 * 1.0)$
 $= 5.312 \text{ MPa}$

Minimum Design Metal Temperature Results:

$t_g = 13.0$, $t_{g_sr} = 27.0$, $t_r = 5.103$, $c = 1.0 \text{ mm}$, $E * = 1.0$
 Thickness Ratio = $t_r * E * / (t_{g_sr} - c) = 0.196$, Temp. Reduction = $78 \text{ }^\circ\text{C}$

Min Metal Temp. w/o impact per UCS-66, Curve B	-21 °C
Min Metal Temp. at Required thickness (UCS 66.1)	-104 °C
Min Metal Temp. w/o impact per UG-20(f)	-29 °C

Cylindrical Shell From 20 To 30 SA-516 70 , UCS-66 Crv. B at 95 °C

Channel head cylinder

Longitudinal Joint: User Defined

Material UNS Number: K02700

Required Thickness due to Internal Pressure [tr]:
 $= (P * R_o) / (S * E + 0.4 * P)$ per Appendix 1-1 (a)(1)
 $= (1. * 80.0) / (137.9 * 1.0 + 0.4 * 1.0)$
 $= 0.5785 + 1.0000 = 1.5785 \text{ mm}$

Note: The thickness required was less than the Code Minimum, therefore the Code Minimum value of 2.5000 mm per UG-16 will be used.

Max. Allowable Working Pressure at given Thickness, corroded [MAWP]:
 $= (S * E * t) / (R_o - 0.4 * t)$ per Appendix 1-1 (a)(1)
 $= (137.9 * 1.0 * 12.0) / (80.0 - 0.4 * 12.0)$
 $= 22 \text{ MPa}$

Maximum Allowable Pressure, New and Cold [MAPNC]:
 $= (S * E * t) / (R_o - 0.4 * t)$ per Appendix 1-1 (a)(1)
 $= (137.9 * 1.0 * 13.0) / (80.0 - 0.4 * 13.0)$
 $= 24 \text{ MPa}$

Strength Calculation PV-Elite
 IWS-Monje Heat Exchangers GmbH
 Wittener Str. 102, 44789 Bochum, Germany
 PV Elite 24 Licensee: IWS-Monje? Heat Exchangers GmbH
 FileName : BK12-3103-L1200_Airpack-17811_Rev00_neuaufbau.pv P
 Internal Pressure Calculations: Step: 7 1:49am May 5,2022

Actual stress at given pressure and thickness, corroded [Sact]:

$$\begin{aligned}
 &= (P*(Ro-0.4*t))/(E*t) \\
 &= (1.*((80.0-0.4*12.0))/(1.0*12.0)) \\
 &= 6.267 \text{ MPa}
 \end{aligned}$$

% Elongation per Table UG-79-1 (50*tnom/Rf*(1-Rf/Ro)) 8.844 %

Note: Please Check Requirements of UCS-79 as Elongation is > 5%.

Minimum Design Metal Temperature Results:

Govrn. thk, tg = 13.0, tr = 2.5, c = 1.0 mm, E* = 1.0

Thickness Ratio = tr * E*/(tg - c) = 0.208, Temp. Reduction = 78 °C

Min Metal Temp. w/o impact per UCS-66, Curve B	-21 °C
Min Metal Temp. at Required thickness (UCS 66.1)	-104 °C
Min Metal Temp. w/o impact per UG-20(f)	-29 °C

Cylindrical Shell From 50 To 60 SA-312 TP316 at 210 °C

Main Shell

Longitudinal Joint: User Defined

Material UNS Number: S31600

Required Thickness due to Internal Pressure [tr]:

$$\begin{aligned}
 &= (P*Ro) / (S*E+0.4*P) \text{ per Appendix 1-1 (a)(1)} \\
 &= (2.5*70.65)/(132.2*1.0+0.4*2.5) \\
 &= 1.3260 + 0.0000 = 1.3260 \text{ mm}
 \end{aligned}$$

Note: The thickness required was less than the Code Minimum, therefore the Code Minimum value of 1.5000 mm per UG-16 will be used.

Max. Allowable Working Pressure at given Thickness, corroded [MAWP]:

$$\begin{aligned}
 &= (S*E*t)/(Ro-0.4*t) \text{ per Appendix 1-1 (a)(1)} \\
 &= (132.2*1.0*3.4)/(70.65-0.4*3.4) \\
 &= 6 \text{ MPa}
 \end{aligned}$$

Maximum Allowable Pressure, New and Cold [MAPNC]:

$$\begin{aligned}
 &= (S*E*t)/(Ro-0.4*t) \text{ per Appendix 1-1 (a)(1)} \\
 &= (137.9*1.0*3.4)/(70.65-0.4*3.4) \\
 &= 7 \text{ MPa}
 \end{aligned}$$

Actual stress at given pressure and thickness, corroded [Sact]:

$$\begin{aligned}
 &= (P*(Ro-0.4*t))/(E*t) \\
 &= (2.5*((70.65-0.4*3.4))/(1.0*3.4)) \\
 &= 50.949 \text{ MPa}
 \end{aligned}$$

SA-312 TP316, Min Metal Temp without impact per UHA-51: -196 °C

Note: Heads and Shells Exempted to -20F (-29C) by paragraph UG-20F

Hydrostatic Test Pressure Results:

Exchanger Shell Side Hydrostatic Test Pressures:

Strength Calculation PV-Elite
 IWS-Monje Heat Exchangers GmbH
 Wittener Str. 102, 44789 Bochum, Germany
 PV Elite 24 Licensee: IWS-Monje? Heat Exchangers GmbH
 FileName : BK12-3103-L1200_Airpack-17811_Rev00_neuaufbau.pv P
 Internal Pressure Calculations: Step: 7 1:49am May 5,2022

Pressure per UG99b	= 1.30 * M.A.W.P. * Sa/S	3.390 MPa
Pressure per UG99b[35]	= 1.30 * Design Pres * Sa/S	3.390 MPa
Pressure per UG99c	= 1.30 * M.A.P. - Head(Hyd)	3.248 MPa
Pressure per UG100	= 1.10 * M.A.W.P. * Sa/S	2.869 MPa
Pressure per PED	= max(1.43*DP, 1.25*DP*ratio)	3.575 MPa
Pressure per App 27-4	= M.A.W.P.	2.500 MPa

User defined Hydrostatic Test Pressures:

Shell Side Test Pressure at High Point	3.750 MPa
Channel Side Test Pressure at High Point	1.500 MPa

Exchanger Channel Side Hydrostatic Test Pressures:

Pressure per UG99b	= 1.30 * M.A.W.P. * Sa/S	1.300 MPa
Pressure per UG99b[35]	= 1.30 * Design Pres * Sa/S	1.300 MPa
Pressure per UG99c	= 1.30 * M.A.P. - Head(Hyd)	1.298 MPa
Pressure per UG100	= 1.10 * M.A.W.P. * Sa/S	1.100 MPa
Pressure per PED	= max(1.43*DP, 1.25*DP*ratio)	1.430 MPa
Pressure per App 27-4	= M.A.W.P.	1.000 MPa

Horizontal Test performed per: User Hydro Pressure

Please note that Nozzle, Shell, Head, Flange, etc MAWPs are all considered when determining the hydrotest pressure for those test types that are based on the MAWP of the vessel.

Stresses on Elements due to Test Pressure (MPa):

From To	Stress	Allowable	Ratio	Pressure
Channel head flat	7.4	179.3	0.041	1.50
Channel head cylinde	8.6	179.3	0.048	1.50
Main Shell	76.5	179.3	0.426	3.75

Stress ratios for Nozzle and Pad Materials (MPa):

Description	Pad/Nozzle	Ambient	Operating	Ratio
Noz N1 Fr10 - Tu	Nozzle	117.90	117.90	1.000
Noz N2 Fr10	Nozzle	117.90	117.90	1.000
Noz N3 - Shell i	Nozzle	117.22	112.32	1.044
Noz N4 - Shell o	Nozzle	117.22	112.32	1.044
Minimum				1.000

Stress ratios for Pressurized Vessel Elements (MPa):

Description	Ambient	Operating	Ratio
Channel head flat	137.90	137.90	1.000
Channel head cylinde	137.90	137.90	1.000
Channel head flange	137.90	137.90	1.000
Shell flange ring 1	137.90	131.56	1.048
Main Shell	137.90	132.20	1.043

Strength Calculation PV-Elite
 IWS-Monje Heat Exchangers GmbH
 Wittener Str. 102, 44789 Bochum, Germany
 PV Elite 24 Licensee: IWS-Monje? Heat Exchangers GmbH
 FileName : BK12-3103-L1200_Airpack-17811_Rev00_neuaufbau.pv P
 Internal Pressure Calculations: Step: 7 1:49am May 5,2022

Shell flange ring 2	137.90	131.60	1.048
Cover head	137.90	137.90	1.000

Minimum 1.000

Stress ratios for Exchanger Materials (MPa):

Description	Ambient	Operating	Ratio
Tube Material	68.95	59.71	1.155
Tubesheet Material	115.15	97.91	1.176

Minimum 1.155

Hoop Stress in Nozzle Wall during Pressure Test (MPa):

Description	Ambient	Operating	Ratio
Noz N1 Fr10 - Tu	5.41	153.28	0.035
Noz N2 Fr10	5.41	153.28	0.035
Noz N3 - Shell i	26.78	152.38	0.176
Noz N4 - Shell o	26.78	152.38	0.176

Elements Suitable for Test Pressure.

PV Elite is a trademark of Hexagon AB, 2022, All rights reserved.

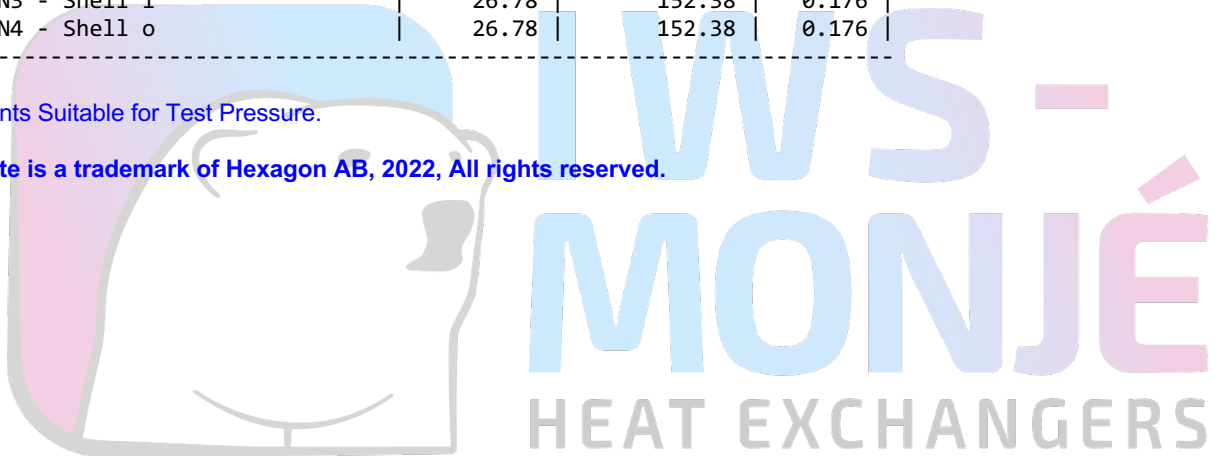

Strength Calculation PV-Elite
 IWS-Monje Heat Exchangers GmbH
 Wittener Str. 102, 44789 Bochum, Germany
 PV Elite 24 Licensee: IWS-Monje? Heat Exchangers GmbH
 FileName : BK12-3103-L1200_Airpack-17811_Rev00_neuaufbau.pv P
 External Pressure Calculations: Step: 8 1:49am May 5,2022

External Pressure Calculation Results :

External Pressure Calculations:

From	To	Section Length mm	Outside Diameter mm	Corroded Thickness mm	Factor A	Factor B MPa
10	20	No Calc	...	26	No Calc	No Calc
20	30	30	160	12	0.096675	122.731
30	40	No Calc	...	17	No Calc	No Calc
40	50	No Calc	...	18	No Calc	No Calc
50	60	1153.8	141.3	3.4	0.00068352	55.1972
60	70	No Calc	...	18	No Calc	No Calc
70	80	No Calc	...	24	No Calc	No Calc

External Pressure Calculations:

From	To	External Actual T. mm	External Required T. mm	External Design Pressure MPa	External M.A.W.P. MPa
10	20	27	No Calc	0.1013	No Calc
20	30	13	1.25164	0.1013	12.2731
30	40	18	10.4394	0.1013	No Calc
40	50	18	6.9596	0.1013	No Calc
50	60	3.4	1.15523	0.1013	1.77089
60	70	18	6.9596	0.1013	No Calc
70	80	25	6.9342	0.1013	No Calc
Minimum					2

External Pressure Calculations:

From	To	Actual Length Bet. Stiffeners mm	Allowable Length Bet. Stiffeners mm	Ring Inertia Required mm ⁴	Ring Inertia Available mm ⁴
10	20	No Calc	No Calc	No Calc	No Calc
20	30	30	3634.68	No Calc	No Calc
30	40	No Calc	No Calc	No Calc	No Calc
40	50	No Calc	No Calc	No Calc	No Calc
50	60	1153.8	82743	No Calc	No Calc
60	70	No Calc	No Calc	No Calc	No Calc
70	80	No Calc	No Calc	No Calc	No Calc

[Elements Suitable for External Pressure.](#)

ASME Code, Section VIII Division 1, 2021

Welded Flat Head

[Channel head flat](#)

Strength Calculation PV-Elite
 IWS-Monje Heat Exchangers GmbH
 Wittener Str. 102, 44789 Bochum, Germany
 PV Elite 24 Licensee: IWS-Monje? Heat Exchangers GmbH
 FileName : BK12-3103-L1200_Airpack-17811_Rev00_neuaufbau.pv P
 External Pressure Calculations: Step: 8 1:49am May 5,2022

Note: This element's required thickness was computed in the internal Pressure Report using the maximum of the Internal and External pressures.

Cylindrical Shell From 50 to 60 Ext. Chart: HA-2 at 210 °C

Main Shell

Elastic Modulus from Chart: HA-2 at 210 °C: 178099 MPa

Results for Maximum Allowable Ext. Pressure							MAEP
Tca	Outer Dia	Slen	Do/t	L/D	Factor A	Factor B	
3.400	141.30	1153.80	41.56	8.1656	0.0006835	55.20	

$$MAEP = (4*B)/(3*(Do/t)) = (4*55.1972)/(3*41.5588) = 1.7709 \text{ MPa}$$

Results for Required Thickness							Tca
Tca	Outer Dia	Slen	Do/t	L/D	Factor A	Factor B	
1.155	141.30	1153.80	122.31	8.1656	0.0001044	9.29	

$$MAEP = (4*B)/(3*(Do/t)) = (4*9.2934)/(3*122.3133) = 0.1013 \text{ MPa}$$

Results for Maximum Stiffened Length							Slen
Tca	Outer Dia	Slen	Do/t	L/D	Factor A	Factor B	
3.400	141.30	82743.00	41.56	50.0000	0.0006433	54.15	

$$MAEP = (4*B)/(3*(Do/t)) = (4*54.1462)/(3*41.5588) = 1.7372 \text{ MPa}$$

PV Elite is a trademark of Hexagon AB, 2022, All rights reserved.

Strength Calculation PV-Elite
 IWS-Monje Heat Exchangers GmbH
 Wittener Str. 102, 44789 Bochum, Germany
 PV Elite 24 Licensee: IWS-Monje? Heat Exchangers GmbH
 FileName : BK12-3103-L1200_Airpack-17811_Rev00_neuaufbau.pv P
 Element and Detail Weights: Step: 9 1:49am May 5,2022

Element and Detail Weights:

From	To	Element Metal Wgt. kg	Element ID Volume ltr	Corroded Metal Wgt. kg	Corroded ID Volume ltr	Extra due Misc %
10	20	4.20749	...	4.05166
20	30	1.39592	0.42315	1.29731	0.43588	...
30	40	3.37665	...	3.37665
40	50	3.73074	0.50023	3.73074	0.50023	...
50	60	13.6425	12.2197	13.6425	12.2197	...
60	70	3.73074	0.50023	3.73074	0.50023	...
70	80	7.36555	...	7.36555
Total		37	13.64	37	13.66	0

For elements specified as shell side elements, the volume(s) shown above for those elements, reflects the displacement of the tubes.

Weight of Details:

From	Type	Weight of Detail kg	X Offset, Dtl. Cent. mm	Y Offset, Dtl. Cent. mm	Z Offset, Dtl. Cent. mm	Description
10	Noz1	0.30781	...	100	...	Noz N1 Fr10 - Tu
10	Noz1	0.32816	...	-100	...	Noz N2 Fr10
50	Noz1	4.92907	72	97.4	...	Noz N3 - Shell i
50	Noz1	4.92907	1092	-97.4	...	Noz N4 - Shell o
30	FTsh	3.79983	36	Tubesheet fix
30	Tube	9.3281	637	Tubes
30	FlTs	2.16206	1252	

Total Weight of Each Detail Type:

Nozzles	10.5
Exchanger Components	15.3

Sum of the Detail Weights	25.8 kg

Weight Summation Results: (kg)

	Fabricated	Shop Test	Shipping	Erected	Empty	Operating
Main Elements	37.4	37.4	37.4	37.4	37.4	37.4
Nozzles	10.5	10.5	10.5	10.5	10.5	10.5
Exchanger	15.3	15.3	15.3	15.3	15.3	15.3
Test Liquid	...	13.6
Tube Tst Lqd	...	3.4

Totals	63.2	80.3	63.2	63.2	63.2	63.2

Weight Summary:

Fabricated Wt. - Bare Weight without Removable Internals 63.2 kg

Strength Calculation PV-Elite

IWS-Monje Heat Exchangers GmbH

Wittener Str. 102, 44789 Bochum, Germany

PV Elite 24 Licensee: IWS-Monje? Heat Exchangers GmbH

FileName : BK12-3103-L1200_Airpack-17811_Rev00_neuaufbau.pv P

Element and Detail Weights: Step: 9 1:49am May 5,2022

Shop Test Wt.	- Fabricated Weight + Water (Full)	80.3 kg
Shipping Wt.	- Fab. Weight + removable Intls.+ Shipping App.	63.2 kg
Erected Wt.	- Fab. Wt + or - loose items (trays,platforms etc.)	63.2 kg
Ope. Wt. no Liq	- Fab. Weight + Internals. + Details + Weights	63.2 kg
Operating Wt.	- Empty Weight + Operating Liq. Uncorroded	63.2 kg
Oper. Wt. + CA	- Corr Wt. + Operating Liquid	63.0 kg
Field Test Wt.	- Empty Weight + Water (Full)	80.3 kg

Exchanger Tube Data

Volume of Exchanger tubes :	3.4 ltr
Weight of Ope Liq in tubes :	0.0 kg
Weight of Water in tubes :	3.4 kg

Note:

The Corroded Weight and thickness are used in the Horizontal Vessel Analysis (Ope Case) and Earthquake Load Calculations.

Outside Surface Areas of Elements:

From	To	Surface Area mm ²
10	20	...
20	30	15079.6
30	40	36644.5
40	50	44591
50	60	512180
60	70	44591
70	80	55292
Total		708378.062 mm ²

PV Elite is a trademark of Hexagon AB, 2022, All rights reserved.



IWS-MONJÉ
HEAT EXCHANGERS

Strength Calculation PV-Elite
 IWS-Monje Heat Exchangers GmbH
 Wittener Str. 102, 44789 Bochum, Germany
 PV Elite 24 Licensee: IWS-Monj? Heat Exchangers GmbH
 FileName : BK12-3103-L1200_Airpack-17811_Rev00_neuaufbau.pv P
 Nozzle Flange MAWP: Step: 10 1:49am May 5,2022

Nozzle Flange MAWP Results: (MPa & °C)

Nozzle Description	Flange Rating		Design Temp	Class	Grade/Group	Equiv. Press	Max Pressure		
	Op.	Ambient					UG-44(b)	50%	DNV
Noz N3 - Shell	3.52	4.96	210	300	GR 2.2
Noz N4 - Shell	3.52	4.96	210	300	GR 2.2

Shellside Flange Rating

Lowest Flange Pressure Rating was (Op)[ShellSide]: 3.524 MPa
 Lowest Flange Pressure Rating was (Amb)[ShellSide]: 4.960 MPa

Channelside Flange Rating

Pressure Ratings are per ASME B16.5 2017 Metric Edition

PV Elite is a trademark of Hexagon AB, 2022, All rights reserved.

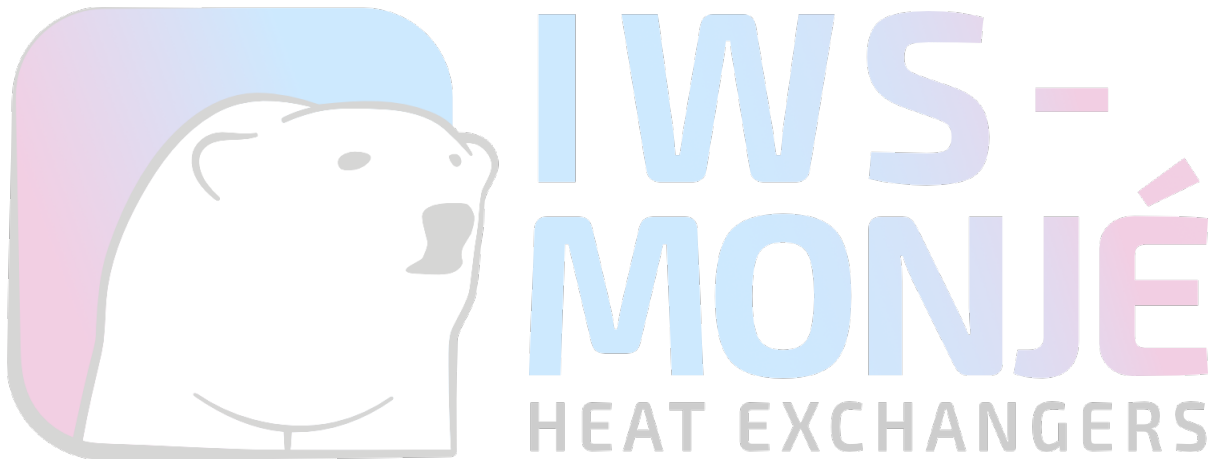

Strength Calculation PV-Elite
 IWS-Monje Heat Exchangers GmbH
 Wittener Str. 102, 44789 Bochum, Germany
 PV Elite 24 Licensee: IWS-Monj? Heat Exchangers GmbH
 FileName : BK12-3103-L1200_Airpack-17811_Rev00_neuaufbau.pv P
 Center of Gravity Calculation: Step: 11 1:49am May 5,2022

Shop/Field Installation Options :

Note : The CG is computed from the first Element From Node

Center of Gravity of the Nozzles	673.102 mm
Center of Gravity of the Tubesheet(s)	551.979 mm
Center of Gravity of the Tubes	712.000 mm
Center of Gravity of Bare Shell New and Cold	673.905 mm
Center of Gravity of Bare Shell Corroded	678.347 mm
Vessel CG in the Operating Condition	670.495 mm
Vessel CG in the Fabricated (Shop/Empty) Condition	667.896 mm

PV Elite is a trademark of Hexagon AB, 2022, All rights reserved.

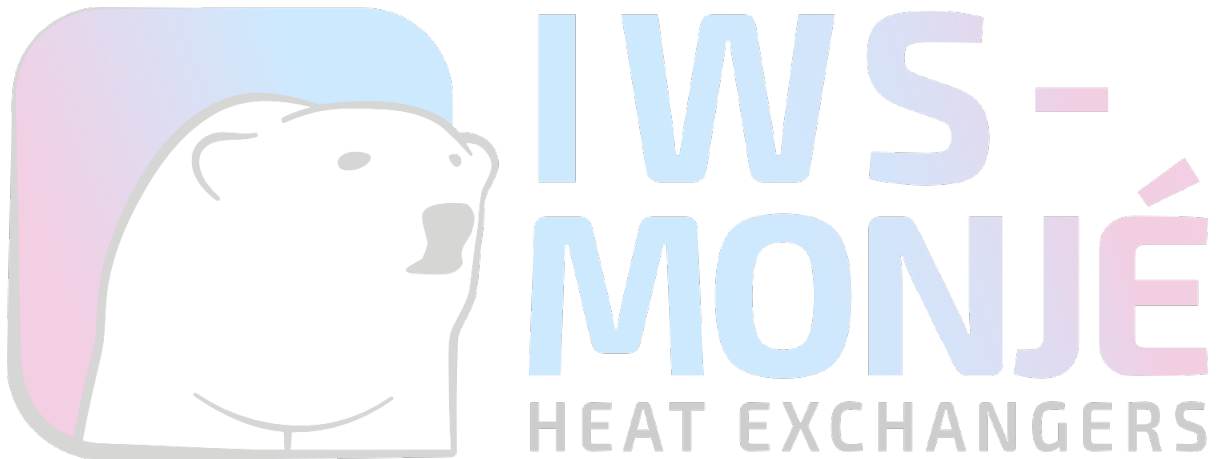

Strength Calculation PV-Elite
 IWS-Monje Heat Exchangers GmbH
 Wittener Str. 102, 44789 Bochum, Germany
 PV Elite 24 Licensee: IWS-Monje? Heat Exchangers GmbH
 FileName : BK12-3103-L1200_Airpack-17811_Rev00_neuaufbau.pv P
 Nozzle Calcs.: Noz N1 Fr10 - T Nozl: 17 1:49am May 5,2022

Input, Nozzle Desc: Noz N1 Fr10 - Tube inlet**From: 10**

Pressure for Reinforcement Calculations	P	1.0000	MPa
Temperature for Internal Pressure	Temp	95	°C
Parent Material		SA-516 70	
Parent Allowable Stress at Temperature	Sv	137.90	MPa
Parent Allowable Stress At Ambient	Sva	137.90	MPa
Outside Diameter of Flat Head	D	160.00	mm
Large Diameter of Flat Head	Dl	160.0000	mm
Flat Head Attachment Factor	F	0.20	
Head Finished (Minimum) Thickness	t	27.0000	mm
Head Internal Corrosion Allowance	c	1.0000	mm
Head External Corrosion Allowance	co	0.0000	mm
Distance from Head Centerline	L1	46.0000	mm
User Entered Minimum Design Metal Temperature		-10.00	°C

Type of Element Connected to the Parent : Nozzle

Material		SA-106 B	
Material UNS Number		K03006	
Material Specification/Type		Smls. pipe	
Allowable Stress at Temperature	Sn	117.90	MPa
Allowable Stress At Ambient	Sna	117.90	MPa
Diameter Basis (for tr calc only)		Outside	
Layout Angle		90.00	deg
Diameter		40.0000	mm
Size and Thickness Basis		Actual	
Actual Thickness	tn	5.0000	mm
Corrosion Allowance	can	1.0000	mm
Joint Efficiency of Shell Seam at Nozzle	E1	1.00	
Joint Efficiency of Nozzle Neck	En	1.00	
Outside Projection	ho	50.0000	mm
Weld leg size between Nozzle and Pad/Shell	Wo	10.0000	mm
Groove weld depth between Nozzle and Vessel	Wgnv	0.0000	mm
Inside Projection	h	0.0000	mm
Weld leg size, Inside Element to Shell	Wi	0.0000	mm

The Pressure Design option was Design Pressure + static head.

Nozzle Sketch (may not represent actual weld type/configuration)

Strength Calculation PV-Elite
 IWS-Monje Heat Exchangers GmbH
 Wittener Str. 102, 44789 Bochum, Germany
 PV Elite 24 Licensee: IWS-Monje? Heat Exchangers GmbH
 FileName : BK12-3103-L1200_Airpack-17811_Rev00_neuaufbau.pv P
 Nozzle Calcs.: Noz N1 Fr10 - T Nozl: 17 1:49am May 5,2022

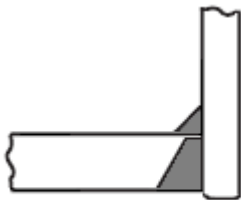

Insert/Set-in Nozzle No Pad, no Inside projection

Reinforcement CALCULATION, Description: Noz N1 Fr10 - Tube inlet

ASME Code, Section VIII, Div. 1, 2021, UG-37 to UG-45

Actual Outside Diameter Used in Calculation 40.000 mm.
 Actual Thickness Used in Calculation 5.000 mm

Nozzle input data check completed without errors.

Reqd thk per UG-37(a) of Welded Flat Head, tr [Int. Press]
 $= d \cdot \sqrt{Z \cdot C \cdot P / (S_v \cdot E)}$ per UG-34 (c)(3)
 $= 134.0 \cdot \sqrt{1.0 \cdot 0.2 \cdot 1. / (138 \cdot 1.0)}$
 $= 5.1031$ mm

Reqd thk per UG-37(a) of Nozzle Wall, trn [Int. Press]
 $= P \cdot R_o / (S_n \cdot E + 0.4 \cdot P)$ per Appendix 1-1 (a)(1)
 $= 1. \cdot 20.0 / (118 \cdot 1.0 + 0.4 \cdot 1.)$
 $= 0.1691$ mm

UG-40, Limits of Reinforcement : [Internal Pressure]

Parallel to Vessel Wall (Diameter Limit)	D1	92.0000	mm
Parallel to Vessel Wall	Rn+tn+t	46.0000	mm
Normal to Vessel Wall (Thickness Limit), no pad	Tlnp	10.0000	mm

*Taking a UG-36(c)(3)(a) exemption for nozzle: Noz N1 Fr10 - T.
 This calculation is valid for nozzles that meet all the requirements of
 paragraph UG-36. Please check the Code carefully, especially for nozzles
 that are not isolated or do not meet Code spacing requirements. To force
 the computation of areas for small nozzles go to Tools->Configuration
 and check the box to force the UG-37 small nozzle area calculation.*

UG-45 Minimum Nozzle Neck Thickness Requirement: [Int. Press.]

Wall Thickness for Internal/External pressures	ta	= 1.1691	mm
Wall Thickness per UG16(b),	tr16b	= 3.5000	mm
Wall Thickness, shell/head, internal pressure	trb1	= 6.1031	mm
Wall Thickness	tb1 = max(trb1, tr16b)	= 6.1031	mm
Wall Thickness	tb2 = max(trb2, tr16b)	= 3.5000	mm
Wall Thickness per table UG-45	tb3	= 4.1200	mm

Determine Nozzle Thickness candidate [tb]:

$= \min[tb3, \max(tb1, tb2)]$
 $= \min[4.12, \max(6.1031, 3.5)]$
 $= 4.1200$ mm

Strength Calculation PV-Elite
 IWS-Monje Heat Exchangers GmbH
 Wittener Str. 102, 44789 Bochum, Germany
 PV Elite 24 Licensee: IWS-Monje? Heat Exchangers GmbH
 FileName : BK12-3103-L1200_Airpack-17811_Rev00_neuaufbau.pv P
 Nozzle Calcs.: Noz N1 Fr10 - T Nozl: 17 1:49am May 5,2022

Minimum Wall Thickness of Nozzle Necks [tUG-45]:

$$= \max(t_a, t_b)$$

$$= \max(1.1691, 4.12)$$

$$= 4.1200 \text{ mm}$$

Available Nozzle Neck Thickness = 5.0000 mm --> OK

Nozzle Junction Minimum Design Metal Temperature (MDMT) Calculations:

Nozzle-Shell/Head Weld (UCS-66(a)1(b)), Curve: B

Govrn. thk, $t_g = 5.0$, $t_r = 0.169$, $c = 1.0$ mm, $E^* = 1.0$
 Thickness Ratio = $t_r * E^* / (t_g - c) = 0.042$, Temp. Reduction = 78 °C

Min Metal Temp. w/o impact per UCS-66, Curve B -29 °C
 Min Metal Temp. at Required thickness (UCS 66.1) -104 °C

Gov. MDMT of the nozzle to shell joint welded assembly : -104 °C

Weld Size Calculations, Description: Noz N1 Fr10 - T

Intermediate Calc. for nozzle/shell Welds $T_{min} = 4.0000$ mm

Results Per UW-16.1:

	Required Thickness	Actual Thickness
Nozzle Weld	$2.8000 = 0.7 * t_{min}$	$7.0700 = 0.7 * W_o$ mm

Skipping the nozzle attachment weld strength calculations. Per UW-15(b)(2) the nozzles exempted by UG-36(c)(3)(a) (small nozzles) do not require a weld strength check.

Maximum Allowable Pressure for this Nozzle at this Location:

Converged Maximum Allowable Pressure in the Operating case: 1 MPa

Note: The MAWP of this junction was limited by the parent Shell/Head.

The Cut Length for this Nozzle is, Drop + Ho + H + T : 77.0508 mm

PV Elite is a trademark of Hexagon AB, 2022, All rights reserved.

Strength Calculation PV-Elite
 IWS-Monje Heat Exchangers GmbH
 Wittener Str. 102, 44789 Bochum, Germany
 PV Elite 24 Licensee: IWS-Monje? Heat Exchangers GmbH
 FileName : BK12-3103-L1200_Airpack-17811_Rev00_neuaufbau.pv P
 Nozzle Calcs.: Noz N2 Fr10 Nozl: 18 1:49am May 5,2022

Input, Nozzle Desc: Noz N2 Fr10**From: 10**

Pressure for Reinforcement Calculations	P	1.0000	MPa
Temperature for Internal Pressure	Temp	95	°C
Parent Material		SA-516 70	
Parent Allowable Stress at Temperature	Sv	137.90	MPa
Parent Allowable Stress At Ambient	Sva	137.90	MPa
Outside Diameter of Flat Head	D	160.00	mm
Large Diameter of Flat Head	Dl	160.0000	mm
Flat Head Attachment Factor	F	0.20	
Head Finished (Minimum) Thickness	t	27.0000	mm
Head Internal Corrosion Allowance	c	1.0000	mm
Head External Corrosion Allowance	co	0.0000	mm
Distance from Head Centerline	L1	46.0000	mm
User Entered Minimum Design Metal Temperature		-10.00	°C

Type of Element Connected to the Parent : Nozzle

Material		SA-106 B	
Material UNS Number		K03006	
Material Specification/Type		Smls. pipe	
Allowable Stress at Temperature	Sn	117.90	MPa
Allowable Stress At Ambient	Sna	117.90	MPa
Diameter Basis (for tr calc only)		Outside	
Layout Angle		270.00	deg
Diameter		40.0000	mm
Size and Thickness Basis		Actual	
Actual Thickness	tn	5.0000	mm
Corrosion Allowance	can	1.0000	mm
Joint Efficiency of Shell Seam at Nozzle	E1	1.00	
Joint Efficiency of Nozzle Neck	En	1.00	
Outside Projection	ho	50.0000	mm
Weld leg size between Nozzle and Pad/Shell	Wo	10.0000	mm
Groove weld depth between Nozzle and Vessel	Wgnv	0.0000	mm
Inside Projection	h	0.0000	mm
Weld leg size, Inside Element to Shell	Wi	0.0000	mm

The Pressure Design option was Design Pressure + static head.

Nozzle Sketch (may not represent actual weld type/configuration)

Strength Calculation PV-Elite
 IWS-Monje Heat Exchangers GmbH
 Wittener Str. 102, 44789 Bochum, Germany
 PV Elite 24 Licensee: IWS-Monje? Heat Exchangers GmbH
 FileName : BK12-3103-L1200_Airpack-17811_Rev00_neuaufbau.pv P
 Nozzle Calcs.: Noz N2 Fr10 Nozl: 18 1:49am May 5,2022

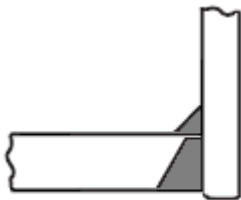

Insert/Set-in Nozzle No Pad, no Inside projection

Reinforcement CALCULATION, Description: Noz N2 Fr10

ASME Code, Section VIII, Div. 1, 2021, UG-37 to UG-45

Actual Outside Diameter Used in Calculation 40.000 mm.
 Actual Thickness Used in Calculation 5.000 mm

Nozzle input data check completed without errors.

Reqd thk per UG-37(a) of Welded Flat Head, tr [Int. Press]
 $= d \cdot \sqrt{Z \cdot C \cdot P / (S_v \cdot E)}$ per UG-34 (c)(3)
 $= 134.0 \cdot \sqrt{1.0 \cdot 0.2 \cdot 1. / (138 \cdot 1.0)}$
 $= 5.1031 \text{ mm}$

Reqd thk per UG-37(a) of Nozzle Wall, trn [Int. Press]
 $= P \cdot R_o / (S_n \cdot E + 0.4 \cdot P)$ per Appendix 1-1 (a)(1)
 $= 1. \cdot 20.0 / (118 \cdot 1.0 + 0.4 \cdot 1.)$
 $= 0.1691 \text{ mm}$

UG-40, Limits of Reinforcement : [Internal Pressure]

Parallel to Vessel Wall (Diameter Limit)	D1	92.0000 mm
Parallel to Vessel Wall	Rn+tn+t	46.0000 mm
Normal to Vessel Wall (Thickness Limit), no pad	Tlnp	10.0000 mm

Taking a UG-36(c)(3)(a) exemption for nozzle: Noz N2 Fr10.

This calculation is valid for nozzles that meet all the requirements of paragraph UG-36. Please check the Code carefully, especially for nozzles that are not isolated or do not meet Code spacing requirements. To force the computation of areas for small nozzles go to Tools->Configuration and check the box to force the UG-37 small nozzle area calculation.

UG-45 Minimum Nozzle Neck Thickness Requirement: [Int. Press.]

Wall Thickness for Internal/External pressures	ta	= 1.1691 mm
Wall Thickness per UG16(b),	tr16b	= 3.5000 mm
Wall Thickness, shell/head, internal pressure	trb1	= 6.1031 mm
Wall Thickness	tb1 = max(trb1, tr16b)	= 6.1031 mm
Wall Thickness	tb2 = max(trb2, tr16b)	= 3.5000 mm
Wall Thickness per table UG-45	tb3	= 4.1200 mm

Determine Nozzle Thickness candidate [tb]:

= min[tb3, max(tb1, tb2)]
 = min[4.12, max(6.1031, 3.5)]
 = 4.1200 mm

Strength Calculation PV-Elite
 IWS-Monje Heat Exchangers GmbH
 Wittener Str. 102, 44789 Bochum, Germany
 PV Elite 24 Licensee: IWS-Monje? Heat Exchangers GmbH
 FileName : BK12-3103-L1200_Airpack-17811_Rev00_neuaufbau.pv P
 Nozzle Calcs.: Noz N2 Fr10 Nozl: 18 1:49am May 5,2022

Minimum Wall Thickness of Nozzle Necks [tUG-45]:

$$= \max(t_a, t_b)$$

$$= \max(1.1691, 4.12)$$

$$= 4.1200 \text{ mm}$$

Available Nozzle Neck Thickness = 5.0000 mm --> OK

Nozzle Junction Minimum Design Metal Temperature (MDMT) Calculations:

Nozzle-Shell/Head Weld (UCS-66(a)1(b)), Curve: B

Govrn. thk, $t_g = 5.0$, $t_r = 0.169$, $c = 1.0$ mm, $E^* = 1.0$
 Thickness Ratio = $t_r * E^* / (t_g - c) = 0.042$, Temp. Reduction = 78 °C

Min Metal Temp. w/o impact per UCS-66, Curve B -29 °C
 Min Metal Temp. at Required thickness (UCS 66.1) -104 °C

Gov. MDMT of the nozzle to shell joint welded assembly : -104 °C

Weld Size Calculations, Description: Noz N2 Fr10

Intermediate Calc. for nozzle/shell Welds $T_{min} = 4.0000$ mm

Results Per UW-16.1:

	Required Thickness	Actual Thickness
Nozzle Weld	$2.8000 = 0.7 * t_{min}$	$7.0700 = 0.7 * W_o$ mm

Skipping the nozzle attachment weld strength calculations. Per UW-15(b)(2) the nozzles exempted by UG-36(c)(3)(a) (small nozzles) do not require a weld strength check.

Maximum Allowable Pressure for this Nozzle at this Location:

Converged Maximum Allowable Pressure in the Operating case: 1 MPa

Note: The MAWP of this junction was limited by the parent Shell/Head.

The Cut Length for this Nozzle is, Drop + Ho + H + T : 77.0508 mm

PV Elite is a trademark of Hexagon AB, 2022, All rights reserved.

Strength Calculation PV-Elite
 IWS-Monje Heat Exchangers GmbH
 Wittener Str. 102, 44789 Bochum, Germany
 PV Elite 24 Licensee: IWS-Monje? Heat Exchangers GmbH
 FileName : BK12-3103-L1200_Airpack-17811_Rev00_neuaufbau.pv P
 Nozzle Calcs.: Noz N3 - Shell Nozl: 19 1:49am May 5,2022

Input, Nozzle Desc: Noz N3 - Shell inlet**From: 50**

Pressure for Reinforcement Calculations	P	2.5000	MPa
Temperature for Internal Pressure	Temp	210	°C
Design External Pressure	Pext	0.10	MPa
Temperature for External Pressure	Tempex	210	°C

Parent Material		SA-312 TP316	
Parent Allowable Stress at Temperature	Sv	132.20	MPa
Parent Allowable Stress At Ambient	Sva	137.90	MPa

Inside Diameter of Cylindrical Shell	D	134.50	mm
Design Length of Section	L	1153.8000	mm
Shell Finished (Minimum) Thickness	t	3.4000	mm
Shell Internal Corrosion Allowance	c	0.0000	mm
Shell External Corrosion Allowance	co	0.0000	mm

Distance from Bottom/Left Tangent		206.53	mm
-----------------------------------	--	--------	----

User Entered Minimum Design Metal Temperature		-10.00	°C
---	--	--------	----

Type of Element Connected to the Parent : Nozzle

Material		SA-312 TP316	
Material UNS Number		S31600	
Material Specification/Type		Wld. pipe	
Allowable Stress at Temperature	Sn	132.14	MPa
Allowable Stress At Ambient	Sna	137.90	MPa

Note: The allowables above have been divided by 0.85, see UG-37 [S].

Diameter Basis (for tr calc only)		Outside	
Layout Angle		90.00	deg
Diameter		60.3000	mm

Size and Thickness Basis		Actual	
Actual Thickness	tn	4.0000	mm

Flange Type		Weld Neck Flange	
-------------	--	------------------	--

Corrosion Allowance	can	0.0000	mm
Joint Efficiency of Shell Seam at Nozzle	E1	1.00	
Joint Efficiency of Nozzle Neck	En	1.00	

Outside Projection	ho	39.0000	mm
Weld leg size between Nozzle and Pad/Shell	Wo	10.0000	mm
Groove weld depth between Nozzle and Vessel	Wgnv	0.0000	mm

Flange Class		300	
Flange Grade		GR 2.2	

The Pressure Design option was Design Pressure + static head.

Nozzle Sketch (may not represent actual weld type/configuration)

Strength Calculation PV-Elite
 IWS-Monje Heat Exchangers GmbH
 Wittener Str. 102, 44789 Bochum, Germany
 PV Elite 24 Licensee: IWS-Monje? Heat Exchangers GmbH
 FileName : BK12-3103-L1200_Airpack-17811_Rev00_neuaufbau.pv P
 Nozzle Calcs.: Noz N3 - Shell Nozl: 19 1:49am May 5,2022

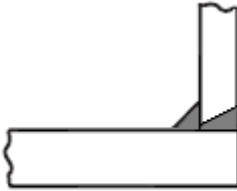

Abutting/Set-on Nozzle No Pad

Reinforcement CALCULATION, Description: Noz N3 - Shell inlet

ASME Code, Section VIII, Div. 1, 2021, UG-37 to UG-45

Actual Outside Diameter Used in Calculation 60.300 mm.
 Actual Thickness Used in Calculation 4.000 mm

Nozzle input data check completed without errors.

Reqd thk per UG-37(a) of Cylindrical Shell, tr [Int. Press]
 = $P \cdot R / (S_v \cdot E - 0.6 \cdot P)$ per UG-27 (c)(1)
 = $2.5 \cdot 67.25 / (132 \cdot 1.0 - 0.6 \cdot 2.5)$
 = 1.2863 mm

Reqd thk per UG-37(a) of Nozzle Wall, trn [Int. Press]
 = $P \cdot R_o / (S_n \cdot E + 0.4 \cdot P)$ per Appendix 1-1 (a)(1)
 = $2.5 \cdot 30.15 / (132 \cdot 1.0 + 0.4 \cdot 2.5)$
 = 0.5661 mm

Required Nozzle thickness under External Pressure per UG-28 : 0.1670 mm

UG-40, Limits of Reinforcement : [Internal Pressure]

Parallel to Vessel Wall (Diameter Limit)	D1	104.6000 mm
Parallel to Vessel Wall, opening length	d	52.3000 mm
Normal to Vessel Wall (Thickness Limit), no pad	Tlnp	8.5000 mm

Taking a UG-36(c)(3)(a) exemption for nozzle: Noz N3 - Shell.

This calculation is valid for nozzles that meet all the requirements of paragraph UG-36. Please check the Code carefully, especially for nozzles that are not isolated or do not meet Code spacing requirements. To force the computation of areas for small nozzles go to Tools->Configuration and check the box to force the UG-37 small nozzle area calculation.

UG-45 Minimum Nozzle Neck Thickness Requirement: [Int. Press.]

Wall Thickness for Internal/External pressures	ta	= 0.5661 mm
Wall Thickness per UG16(b),	tr16b	= 1.5000 mm
Wall Thickness, shell/head, internal pressure	trb1	= 1.2863 mm
Wall Thickness	tb1 = max(trb1, tr16b)	= 1.5000 mm
Wall Thickness	tb2 = max(trb2, tr16b)	= 1.5000 mm
Wall Thickness per table UG-45	tb3	= 3.4200 mm

Determine Nozzle Thickness candidate [tb]:

= min[tb3, max(tb1,tb2)]

Strength Calculation PV-Elite
 IWS-Monje Heat Exchangers GmbH
 Wittener Str. 102, 44789 Bochum, Germany
 PV Elite 24 Licensee: IWS-Monje? Heat Exchangers GmbH
 FileName : BK12-3103-L1200_Airpack-17811_Rev00_neuaufbau.pv P
 Nozzle Calcs.: Noz N3 - Shell Noz1: 19 1:49am May 5,2022

$$= \min[3.42, \max(1.5, 1.5)]$$

$$= 1.5000 \text{ mm}$$

Minimum Wall Thickness of Nozzle Necks [tUG-45]:
 $= \max(t_a, t_b)$
 $= \max(0.5661, 1.5)$
 $= 1.5000 \text{ mm}$

Available Nozzle Neck Thickness = 4.0000 mm --> OK

SA-312 TP316, Min Metal Temp without impact per UHA-51: -196 °C

Weld Size Calculations, Description: Noz N3 - Shell

Intermediate Calc. for nozzle/shell welds t_{min} 3.4000 mm

Results Per UW-16.1:

	Required Thickness	Actual Thickness
Nozzle Weld	$2.3800 = 0.7 * t_{min}$	$7.0700 = 0.7 * W_o$ mm

Skipping the nozzle attachment weld strength calculations. Per UW-15(b)(2) the nozzles exempted by UG-36(c)(3)(a) (small nozzles) do not require a weld strength check.

Maximum Allowable Pressure for this Nozzle at this Location:

Converged Maximum Allowable Pressure in the Operating case: 2 MPa

Note: The MAWP of this junction was limited by the parent Shell/Head.

The Drop for this Nozzle is : 7.1373 mm

The Cut Length for this Nozzle is, Drop + Ho + H + T : 49.5373 mm

PV Elite is a trademark of Hexagon AB, 2022, All rights reserved.

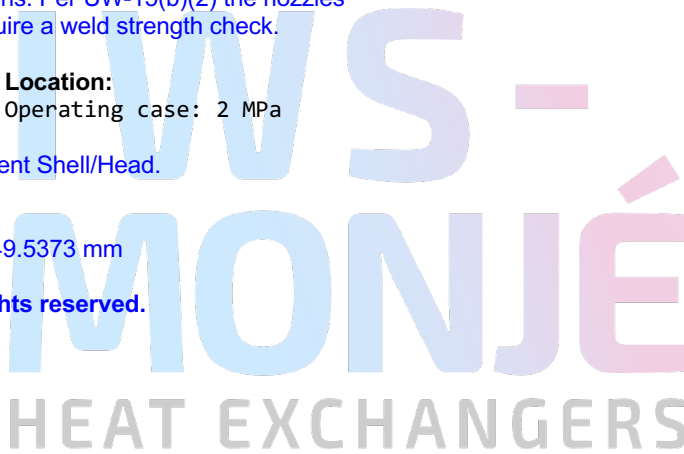
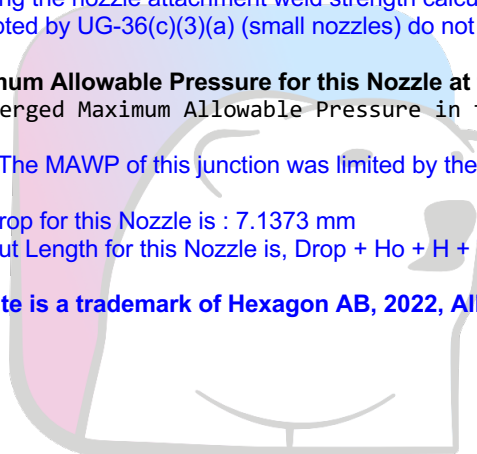

Strength Calculation PV-Elite
 IWS-Monje Heat Exchangers GmbH
 Wittener Str. 102, 44789 Bochum, Germany
 PV Elite 24 Licensee: IWS-Monje? Heat Exchangers GmbH
 FileName : BK12-3103-L1200_Airpack-17811_Rev00_neuaufbau.pv P
 Nozzle Calcs.: Noz N4 - Shell Nozl: 20 1:49am May 5,2022

Input, Nozzle Desc: Noz N4 - Shell outlet**From: 50**

Pressure for Reinforcement Calculations	P	2.5000	MPa
Temperature for Internal Pressure	Temp	210	°C
Design External Pressure	Pext	0.10	MPa
Temperature for External Pressure	Tempex	210	°C

Parent Material		SA-312 TP316	
Parent Allowable Stress at Temperature	Sv	132.20	MPa
Parent Allowable Stress At Ambient	Sva	137.90	MPa

Inside Diameter of Cylindrical Shell	D	134.50	mm
Design Length of Section	L	1153.8000	mm
Shell Finished (Minimum) Thickness	t	3.4000	mm
Shell Internal Corrosion Allowance	c	0.0000	mm
Shell External Corrosion Allowance	co	0.0000	mm

Distance from Bottom/Left Tangent		1226.53	mm
-----------------------------------	--	---------	----

User Entered Minimum Design Metal Temperature		-10.00	°C
---	--	--------	----

Type of Element Connected to the Parent : Nozzle

Material		SA-312 TP316	
Material UNS Number		S31600	
Material Specification/Type		Wld. pipe	
Allowable Stress at Temperature	Sn	132.14	MPa
Allowable Stress At Ambient	Sna	137.90	MPa

Note: The allowables above have been divided by 0.85, see UG-37 [S].

Diameter Basis (for tr calc only)		Outside	
Layout Angle		270.00	deg
Diameter		60.3000	mm

Size and Thickness Basis		Actual	
Actual Thickness	tn	4.0000	mm

Flange Type		Weld Neck Flange	
-------------	--	------------------	--

Corrosion Allowance	can	0.0000	mm
Joint Efficiency of Shell Seam at Nozzle	E1	1.00	
Joint Efficiency of Nozzle Neck	En	1.00	

Outside Projection	ho	39.0000	mm
Weld leg size between Nozzle and Pad/Shell	Wo	10.0000	mm
Groove weld depth between Nozzle and Vessel	Wgnv	3.4000	mm

Flange Class		300	
Flange Grade		GR 2.2	

The Pressure Design option was Design Pressure + static head.

Nozzle Sketch (may not represent actual weld type/configuration)

Strength Calculation PV-Elite
 IWS-Monje Heat Exchangers GmbH
 Wittener Str. 102, 44789 Bochum, Germany
 PV Elite 24 Licensee: IWS-Monje Heat Exchangers GmbH
 FileName : BK12-3103-L1200_Airpack-17811_Rev00_neuaufbau.pv P
 Nozzle Calcs.: Noz N4 - Shell Nozl: 20 1:49am May 5,2022

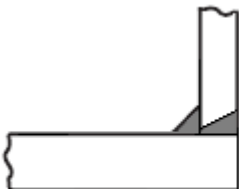

Abutting/Set-on Nozzle No Pad

Reinforcement CALCULATION, Description: Noz N4 - Shell outlet

ASME Code, Section VIII, Div. 1, 2021, UG-37 to UG-45

Actual Outside Diameter Used in Calculation 60.300 mm.
 Actual Thickness Used in Calculation 4.000 mm

Nozzle input data check completed without errors.

Reqd thk per UG-37(a) of Cylindrical Shell, tr [Int. Press]
 = $P \cdot R / (S_v \cdot E - 0.6 \cdot P)$ per UG-27 (c)(1)
 = $2.5 \cdot 67.25 / (132 \cdot 1.0 - 0.6 \cdot 2.5)$
 = 1.2863 mm

Reqd thk per UG-37(a) of Nozzle Wall, trn [Int. Press]
 = $P \cdot R_o / (S_n \cdot E + 0.4 \cdot P)$ per Appendix 1-1 (a)(1)
 = $2.5 \cdot 30.15 / (132 \cdot 1.0 + 0.4 \cdot 2.5)$
 = 0.5661 mm

Required Nozzle thickness under External Pressure per UG-28 : 0.1670 mm

UG-40, Limits of Reinforcement : [Internal Pressure]

Parallel to Vessel Wall (Diameter Limit)	D1	104.6000 mm
Parallel to Vessel Wall, opening length	d	52.3000 mm
Normal to Vessel Wall (Thickness Limit), no pad	Tlnp	8.5000 mm

Taking a UG-36(c)(3)(a) exemption for nozzle: Noz N4 - Shell.

This calculation is valid for nozzles that meet all the requirements of paragraph UG-36. Please check the Code carefully, especially for nozzles that are not isolated or do not meet Code spacing requirements. To force the computation of areas for small nozzles go to Tools->Configuration and check the box to force the UG-37 small nozzle area calculation.

UG-45 Minimum Nozzle Neck Thickness Requirement: [Int. Press.]

Wall Thickness for Internal/External pressures	ta	= 0.5661 mm
Wall Thickness per UG16(b),	tr16b	= 1.5000 mm
Wall Thickness, shell/head, internal pressure	trb1	= 1.2863 mm
Wall Thickness	tb1 = max(trb1, tr16b)	= 1.5000 mm
Wall Thickness	tb2 = max(trb2, tr16b)	= 1.5000 mm
Wall Thickness per table UG-45	tb3	= 3.4200 mm

Determine Nozzle Thickness candidate [tb]:

= min[tb3, max(tb1,tb2)]

Strength Calculation PV-Elite
 IWS-Monje Heat Exchangers GmbH
 Wittener Str. 102, 44789 Bochum, Germany
 PV Elite 24 Licensee: IWS-Monje? Heat Exchangers GmbH
 FileName : BK12-3103-L1200_Airpack-17811_Rev00_neuaufbau.pv P
 Nozzle Calcs.: Noz N4 - Shell Nozl: 20 1:49am May 5,2022

$$= \min[3.42, \max(1.5, 1.5)]$$

$$= 1.5000 \text{ mm}$$

Minimum Wall Thickness of Nozzle Necks [tUG-45]:
 = max(ta, tb)
 = max(0.5661, 1.5)
 = 1.5000 mm

Available Nozzle Neck Thickness = 4.0000 mm --> OK

SA-312 TP316, Min Metal Temp without impact per UHA-51: -196 °C

Weld Size Calculations, Description: Noz N4 - Shell

Intermediate Calc. for nozzle/shell welds Tmin 3.4000 mm

Results Per UW-16.1:

	Required Thickness	Actual Thickness
Nozzle Weld	2.3800 = 0.7 * tmin.	7.0700 = 0.7 * Wo mm

Skipping the nozzle attachment weld strength calculations. Per UW-15(b)(2) the nozzles exempted by UG-36(c)(3)(a) (small nozzles) do not require a weld strength check.

Maximum Allowable Pressure for this Nozzle at this Location:

Converged Maximum Allowable Pressure in the Operating case: 2 MPa

Note: The MAWP of this junction was limited by the parent Shell/Head.

The Drop for this Nozzle is : 7.1373 mm

The Cut Length for this Nozzle is, Drop + Ho + H + T : 49.5373 mm

PV Elite is a trademark of Hexagon AB, 2022, All rights reserved.

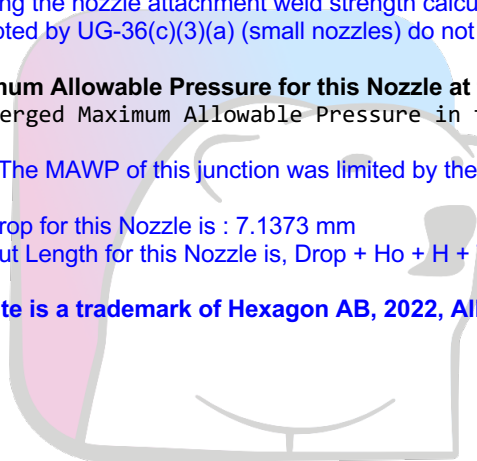

IWS -
 MONJÉ
 HEAT EXCHANGERS