





OWNER:  شرکت سست و سوبی توهمه ایران (سهامی خاص)	BUSHEHR PETROCHEMICAL COMPANY MEG PLANT							EPC CONTRACTOR:  Chagalesh-Enerchimi-Steam Joint Venture BUPC-MEG PLANT PROJECT	
	SIL REPORT							 Netherlands	
MC :   شرکت سست و سوبی توهمه ایران (سهامی خاص)	Project	Area	Phase	Unit	Dis.	Doc.	Seq.	Contract No : 52-98/445	
Owner Document Number: 17811-78	BU	20	VD	303	QC	REP	0105	Rev.:	Page
								02	1 of 48

HAZOP / SIL REPORT

02	19/01/2023	Approve For Construction	KP	CL	JR	
01	09/01/2023	For Information	KP	CL	JR	
00	13/05/2022	For Information	KP	CL	JR	
Rev.	Date	Purpose of Issue	Prepared	Checked	Approved	AC Code
					Class: 3	Phase: P



RISKCONTROL

**REPORT NO.
1189837.01.22**

REVISION R0

**BUPC MEG Plant HAZOP & SIL Report –
N2 and Air Compressor
Detailed Design**

Client Report No: BUPC-17811-OO-0703

AIR Pack Nederland B.V.

Groene Weegje 19-25

4301 RN Zierikzee

Netherlands

E-Mail: airpack@airpack.nl



Bureau Veritas Riskcontrol is a tradename of Riskcontrol B.V.

Plotterweg 38

3821 BB Amersfoort

Nederland

Postadres

Postbus 2620

3800 GD Amersfoort

Tel: +31 (0)88 - 450 55 00

Fax: +31 (0)88 - 450 55 99ING Bank NL29 INGB 0007 4480 31

www.bureauveritas.nl

KvK Utrecht 30089057

consultancynederland@nl.bureauveritas.com



RISKCONTROL

REP.1189837.01.22

**HAZOP & SIL REPORT
BUPC MEG PLANT - AIRPACK**

TABLE OF CONTENTS

TABLE OF CONTENTS	2
DOCUMENT CONTROL SHEET	3
1 Executive summary	4
2 General information	6
2.1 Introduction	6
2.2 Process description	7
2.3 Scope & objectives.....	8
2.4 References.....	9
2.5 HAZOP & SIL assumptions.....	9
3 HAZOP methodology	11
3.1 Node selection.....	11
3.2 Guidewords, process parameters & deviations	12
3.3 Causes & consequences	14
4 SIL methodology	15
4.1 SIL allocation study.....	15
4.2 SIL allocation steps.....	17
5 Conclusion and recommendations	19
5.1 Conclusion.....	19
5.2 Recommendations, close out and actions	21
6 Appendices	22
6.1 Appendix 1: Mark-up P&ID's.....	22
6.2 Appendix 2: HAZOP & SIL worksheets	22
6.3 Appendix 3: HAZOP & SIL recommendation list	22
6.4 Appendix 4: Reference P&ID's and 'reference documents list.....	22
6.5 Appendix 5: Attendance record list.....	22



RISKCONTROL

REP.1189837.01.22

**HAZOP & SIL REPORT
BUPC MEG PLANT - AIRPACK**

DOCUMENT CONTROL SHEET

Prepared for:

Name of company	Air Pack Nederland B.V.
Contact person	Mr. J. (Jeroen) Rust – Engineering Manager
Address	Groene Weegje 19-25
Postcode and city	4301 RN Zierikzee Netherlands
Telephone	-
Email	Airpack@Airpack.nl

Prepared by:

Department	Bureau Veritas Riskcontrol ¹
Contact person	Tobias Jansen Sjak Rijnaarts
Address	Computerweg 2
Postcode and city	3821 AB AMERSFOORT
Telephone	+31 88 450 5750
Email person	sjak.rijnaarts.ext@bureauveritas.com ; tobias.jansen@bureauveritas.com
Email common	consultancynederland@nl.bureauveritas.com

Report details:

Version	Version date	Status	Remarks
0.1	26-04-2022	Draft	For internal comment
1.0	10-05-2022	Released	Released for client approval

¹ Bureau Veritas Riskcontrol is a trade name of Riskcontrol B.V.



1 EXECUTIVE SUMMARY

Bureau Veritas Riskcontrol (BV) was commissioned by Air Pack Nederland B.V. to carry out a Hazard and Operability and SIL (HAZOP & SIL) study for the BUPC MEG plant - Nitrogen and Air Compressor – DD. The study is conducted on April 19th, 2022 and April 25th, 2022.

The study involved representatives from the following companies:

- Air Pack Nederland B.V.
- CES-MEG
- FGS
- Bureau Veritas Riskcontrol

The workshop was facilitated by Bureau Veritas Riskcontrol:

- Mr. S. (Sjak) Rijnaarts (chairman & Scribe)

The overall objectives of the HAZOP workshop were to:

- Identify safety related hazards and operability issues related to the design and operation of the systems;
- Identify excising safeguards that will reduce the expected frequency of occurrence or mitigate the consequences related to the hazards;
- Evaluate the adequacy of existing safeguards;
- Determine the severity of the consequences and the frequency of the causes for the identified problems with safeguards in place; and
- Recommend additional safeguards and improvements, if necessary.
- To assign a target Safety Integrity Level (SIL) to each Process Safety Instrumented Function (SIF) according to the international standard IEC 61508 and IEC 61511

The HAZOP&SIL study was executed in accordance with Jeroen Rust (Air Pack). In the run-up to the HAZOP workshop all P&IDs were divided into manageable and logical sections, called nodes. A total of 4 nodes were identified and studied as presented below. The full sets (several sets are used) of marked-up P&IDs with nodes are available in the master mark-up in **Appendix 1 (App 1)**.

Node	Plant Area	Node Title	Date
01	Air and Nitrogen Compressor	Nitrogen	19.04.2022
02	Air and Nitrogen Compressor	Cooling Water for nitrogen Compressor	19.04.2022
03	Air and Nitrogen Compressor	Air	25.04.2022
04	Air and Nitrogen Compressor	Cooling Water for air Compressor	25.04.2022

Table 1 – Nodes studies per date



RISKCONTROL

REP.1189837.01.22

**HAZOP & SIL REPORT
BUPC MEG PLANT - AIRPACK**

An overview of the workshop outcome is given below:

- The P&IDs were deemed to be of sufficient detail, quality and accuracy for this phase of the design, and adequate as the basis for conducting the HAZOP workshop. The HAZOP made numerous recommendations for P&ID changes and design changes (e.g. instrument/alarm changes) which require P&ID changes, and these should be carried out before the detailed engineering phase is complete.
- No unacceptable safety related scenarios or major operability issues requiring fundamental design changes were found during the workshop. Minor updates and design changes have been recommended in the form of HAZOP recommendations / actions, and these should be closed out before the detailed engineering is complete; for scenarios which are indicated with a hazardous consequence (S in the Worksheets), should be preferably to be closed out before the SIL allocation study is executed.
- The SIL allocation study is done as follow-up of this HAZOP study. 3 SIF's are allocated with a SIL 1 SIF Function in a SIS system.

A total of 4 recommendations/ actions were generated and no issues were noted in a 'Parking Lot'. Follow-up and close-out of all of these items needs to be undertaken during detailed engineering. Records of the HAZOP workshop are presented in **Appendix 2**. The HAZOP recommendations are included in **Appendix 3**. An Excel version of the recommendations and worksheets will also be made available accompanying this document. A reference list of P&ID's and additional engineering documents is included in **Appendix 4**. The attendance record of all participants is included in **Appendix 5**.



2 GENERAL INFORMATION

2.1 Introduction

Bureau Veritas Riskcontrol (BV) was commissioned by Air Pack Nederland B.V. to carry out a Hazard and Operability and SIL (HAZOP & SIL) study for the BUPC MEG plant - Nitrogen and Air Compressor – DD. The study is conducted on April 19th, 2022 and April 25th, 2022.

The study involved representatives from the following companies:

- Air Pack Nederland B.V.
- CES-MEG
- FGS
- Bureau Veritas Riskcontrol

The workshop was facilitated by Bureau Veritas Riskcontrol:

- Mr. S. (Sjak) Rijnaarts (chairman & Scribe)

An attendance record of all workshop sessions weeks is presented in **Appendix 5: Attendance record**. The individual participants are given below.

Name	Company	Role
<i>Sjak Rijnaarts</i>	Bureau Veritas	Workshop Chairman
<i>Dzenita Damjanovic</i>	Bureau Veritas	Project Manager
<i>Kevin Pool</i>	Airpack	Mechanical Lead
<i>Jeroen Rust</i>	Airpack	Project Manager
<i>Brice Kpozuxe</i>	Airpack	Project Manager
<i>Nikan Shahidinia</i>	FGS	Project Expeditor
<i>Mr. Abedi</i>	CES-MEG	Process engineer
<i>Ms. Tchranci</i>	CES-MEG	Process engineer
<i>Mr. Hasemi</i>	CES-MEG	Instrumentation
<i>Ms. Khakpur</i>	CES-MEG	Instrumentation
<i>Mr. Najmeddin</i>	CES-MEG	Safety
<i>Ms. Nazanin Malekinia</i>	HSE	Project expeditor

Table 2 – Participant's list



2.2 Process description

1. Nitrogen Compressor

Nitrogen is supplied to a motor driven two stage piston compressor between 7 and 9 bara from the MEG Plant. Maximum capacity is 565 Nm³/h (707 kg/h). In the inlet is a strainer installed for the removal of loose particles.

The incoming flow can be mixed with a recycle flow from the recycle line with an anti-surge valve from the 2nd stage water cooled discharge, in case the take off to the plant is reduced (max. ca. 20-25% of the maximum capacity).

In both stages in the inlet and outlet an inlet and outlet pulse damper is installed. Downstream of the outlet pulse dampers a water-cooled intercooler, respectively a water cooled aftercooler is installed. Nitrogen will be supplied between 22 and 23.5 bara to the MEG Plant and collected in a vessel (outside the battery limits of this Hazop & SIL study)

Cooling Water (4.5 bar(g)) is supplied and returned from and to the MEG Plant. Cooling water will be divided to the compressor, the intercooler and the aftercooler.

Lube oil is supplied from an oil sump to the bearings of the compressor. A direct driven lube oil pump provides sufficient flow and pressure. Lube oil will be heated when the compressor is out of operation.

2. Air Compressor

Air is supplied to a motor driven one stage piston compressor between 7 and 8.5 bara from the MEG Plant. Maximum capacity is 43 Nm³/h (55 kg/h). In the inlet is a strainer installed for the removal of loose particles.

The incoming flow can be mixed with a recycle flow from the recycle line with an anti-surge valve from the water-cooled discharge, in case the take off to the plant is reduced (max. ca. 20-25% of the maximum capacity).

In the inlet and outlet an inlet and outlet pulse damper is installed. Downstream of the outlet pulse damper a water-cooled aftercooler is installed. Compressed Air will be supplied between 19 and 20 bara to the MEG Plant and collected in a vessel (outside the battery limits of this Hazop & SIL study)

Cooling Water (4.5 bar(g)) is supplied and returned from and to the MEG Plant. Cooling water will be divided to the compressor, the intercooler and the aftercooler.

Lube oil is supplied from an oil sump to the bearings of the compressor. A direct driven lube oil pump provides sufficient flow and pressure. Lube oil will be heated when the compressor is out of operation.



RISKCONTROL

REP.1189837.01.22

**HAZOP & SIL REPORT
BUPC MEG PLANT - AIRPACK**

2.3 Scope & objectives

The objective of the HAZOP & SIL study is to identify potential hazards and operability problems and ensure that the P&IDs show suitable safety and operability features for detail engineering stage of development. The study used guidewords to identify any specific hazards associated with the normal system operation and to discover deviations from design intent and their cause and consequences. The overall objectives of the HAZOP workshop were to:

- Identify safety related hazards and operability issues related to the design and operation of the systems;
- Determine the severity of the consequences and the frequency of the causes for the identified problems;
- Identify existing safeguards that will reduce the expected frequency of occurrence or mitigate the consequences related to the hazards;
- Evaluate the adequacy of existing safeguards; and
- Recommend additional safeguards and improvements, if necessary.

The HAZOP is developed as a structured and systematic brainstorming exercise through the application of specific guidewords with process parameters, to identify possible deviations from the design intent. A set list of deviations has been used as a brainstorming aid. For each deviation, all potential causes have been identified, together with the consequences associated with the cause, and the existing preventative/mitigative controls. When judged necessary by the team, or when no adequate safeguards were present for the specific scenario under analysis, recommendations for reducing risks have been agreed by the HAZOP Team.

The Objective of the SIL Assessment is to assign a target Safety Integrity Level (SIL) to each Process Safety Instrumented Function (SIF) according to the international standard IEC 61508 and IEC 61511. This was done using the BUPC risk matrix approach to SIL determination as documented in HAZOP and SIL Study procedure BUSHEHR PETROCHEMICAL COMPANY MEG PLANT ref. [3].



RISKCONTROL

REP.1189837.01.22

HAZOP & SIL REPORT BUPC MEG PLANT - AIRPACK

2.4 References

In addition to P&IDs, the HAZOP & SIL workshop was carried out based on the following references. A full list of reference P&IDs is documented in **Appendix 4: Reference P&IDs**.

<i>Ref.</i>	<i>Document Reference</i>	<i>Document title</i>	<i>Rev. / date</i>
1	17811-27A	Cause & Effect Chart for Nitrogen compressor	14-04-2022
2	17811-27B	Cause & Effect Chart for INSTRUMENT AIR compressor	14-04-2022
3	17811-48	HAZOP and SIL Study procedure BUSHEHR PETROCHEMICAL COMPANY MEG PLANT	REV 00

2.5 HAZOP & SIL assumptions

The following assumptions and principles were applied to the HAZOP workshop:

<i>Ref.</i>	<i>Assumption</i>
1	SIL determination is done using the Buser Petrochemical Company MEG Plant Hazop and SIL Study Procedure Rev00.
2	Recording of HAZOP discussions and analysis of scenarios will only be done where there is a particular safety, environmental or economical concern. Otherwise, it will be noted that no scenario was identified.
3	Where a scenario has the same consequence and/or safeguards already analysed previously the scenario will not be reanalysed, but a reference to the relevant node index will be made.
4	A reduced set of deviations will be applied to each node. If additional scenarios are discussed beyond the standard deviations they will only be recorded if there is a particular concern, safety impact and/or action.
5	All actions will be assigned to a HAZOP participant who is present at the time the action is generated. This person is responsible for ensuring the action is carried out, but may need to delegate it to a more appropriate person who was not present at the time.
6	Scenarios involving simultaneous occurrence of two unrelated incidents or simultaneous failure of more than one independent protection device (double jeopardy) is not considered credible and are not analysed.
7	Scenarios involving natural events such as flooding and earthquakes are not analysed.
8	Scenarios initiated by deliberate sabotage are not analysed.
9	Where multiple trains of identical equipment are present, only one of the trains/items is analysed and the analysis is equally applicable to the other(s).
10	Pipe classes and equipment/instruments are assumed to be suitable for the design conditions.



RISKCONTROL

REP.1189837.01.22

HAZOP & SIL REPORT BUPC MEG PLANT - AIRPACK

Ref.	Assumption
11	The P&IDs analysed are assumed to be correct and to faithfully represent the current design of the system.
12	Where a node extends to battery limits the consequences outside the battery limits is discussed and recorded, but detailed analysis may not be possible.
13	Only casues of deviations origination inside the node under consideration are analysed.
14	All consequences of a deviation, including within the node and outside the node under consideration are assessed.
15	Credits for Independent Protection Layers are awarded only if the IPLs are: independent of the initiating event such that a failure associated with the risk will not cause the safeguard to fail; testable and verifiable; specific in detecting the hazard and taking action to prevent the hazard from occurring; and capable and available at the time the risk may occur.
16	All consequences are described without considering the safety measures (safeguards) in place.



RISKCONTROL

REP.1189837.01.22

HAZOP & SIL REPORT
BUPC MEG PLANT - AIRPACK

3 HAZOP METHODOLOGY

HAZOP Study is a systematic analysis of the design made through review of the P&IDs, developed in order to assess the possible hazards and the operability issues of the system. The methodology relies on a series of guidewords that are applied to each "Node" to identify process deviations and to investigate their impact on Safety and Operability performances.

3.1 Node selection

In the run-up to the HAZOP workshop all P&IDs were divided into manageable and logical sections, called 'nodes'. A "node" is a system, sub-system or portion of a system which can be analysed by itself, together with the relevant connections to the interfaces. The totality of the nodes shall cover all the Systems under analysis, without missing any portion of them, until the whole Process/Scope of Work is analysed (identical items can be analysed as "typical", addressing only one of them).

The HAZOP&SIL study was executed in accordance with Jeroen Rust (Air Pack). In the run-up to the HAZOP workshop all P&IDs were divided into manageable and logical sections, called nodes. A total of 4 nodes were identified and studied as presented below. The full sets (several sets are used) of marked-up P&IDs with nodes are available in the master mark-up in **Appendix 1 (App 1)**.

Node	Plant Area	Node Title	Date
01	Air and Nitrogen Compressor	Nitrogen	19.04.2022
02	Air and Nitrogen Compressor	Cooling Water N2 Compressor	19.04.2022
03	Air and Nitrogen Compressor	Air	25.04.2022
04	Air and Nitrogen Compressor	Cooling Water Air Compressor	25.04.2022

Table 3 – Nodes studies per date



The following table gives an overview of the equipment covered within each node.

Node	Node Title	Main Equipment	Main Equipment	Date
01	Nitrogen	-20-C-1002 Nitrogen Compressor -20-DC-1002-1 Pulse Damper 1st stage inlet -20-DC-1002-2 Pulse Damper 1st stage discharge	-20-AEC-1002-1 Intercooler -20-DC-1002-3 Pulse Damper 2nd stage inlet -20-DC-1002-4 Pulse Damper 2nd stage discharge -20-AEC-1002-2 Aftercooler -	19.04.2022
02	Cooling Water N2 Compressor	-20-C-1002 Nitrogen Compressor -20-AEC-1002-1 Intercooler -20-AEC-1002-2 Aftercooler		19.04.2022
03	Air	-20-C-7080 Air Compressor -20-DC-7080-1 Pulse Damper inlet	-20-DC-7080-2 Pulse Damper discharge -20-AEC-7080-1 Aftercooler	25.04.2022
04	Cooling Water Air Compressor	-20-C-7080 Air Compressor -20-AEC-7080-1 Aftercooler		25.04.2022

Table 4 – Equipment overview per node

3.2 Guidewords, process parameters & deviations

The HAZOP technique relies on the systematic application of guidewords and process parameters to the various systems comprising the P&IDs. Guidewords are simple words or phrases used to qualify or quantify the intention and associated parameters in order to suggest deviations.

They are used in order to guide and stimulate the brainstorming process. There are seven standard guide words; No, More, Less, As Well As, Part of, Reverse and Other Than, but not all are applicable to each parameter, e.g. 'no' or 'part of' do not apply to the parameter of temperature. Other Than is usually used as a 'catch all' guide word at the end of each parameter. It is important to note that additional guidewords and parameters may be used if required.

For each node, guidewords are considered with reference to the appropriate process parameters in order to develop deviations from the design intent. There is a significant amount of overlap in parameter-guideword combinations. If some deviations appear to be already covered, e.g. 'more flow' may lead to 'more level', then the decision to move on should be made specifically for each guideword and not by assuming that a whole parameter is already covered.



RISKCONTROL

REP.1189837.01.22

HAZOP & SIL REPORT BUPC MEG PLANT - AIRPACK

Deviations are the key to the HAZOP Study process. They are departures from the design intent of the process and are identified by the systematic application of the appropriate parameter/guide word combinations. In some cases the parameter and guideword when combined make a well understood deviation, e.g. less flow. In other cases explanations may need to be developed for the deviation, e.g. as well as flow may more easily be described as 'additional component, and part of flow arises when an element of the flow composition is missing. Some parameter/guidewords combinations are not applicable or not used. An overview of the possible parameters and guidewords, comprises to deviations, is presented below in figure 3 and 4.

Parameters		Deviations
Flow		No/Less Flow
Pressure		More/High Flow
Temperature		Reverse Flow
Level		High Pressure
Utilities		Low Pressure
---		High Temperature
Other		Low Temperature
Composition		High Level
Phase		Low Level
Contamination		Utilities Failure
Viscosity		---
Corrosion		Other
Erosion		More Viscosity
Maintenance		Less Viscosity
Relief		Composition Change
Sampling		Contamination
		Corrosion/Errorsion
	Guidewords	
	No / Not	
	More	
	Less	
	Reverse	
	Part of	
	As well as	
	Other than	
	Other	

Figure 1 - Overview parameters, guidewords and deviations

The default set of deviations used throughout each node is as follows:



RISKCONTROL

REP.1189837.01.22

HAZOP & SIL REPORT BUPC MEG PLANT - AIRPACK

Parameters	Guidewords	Deviations
Flow	No / Not	No/Less Flow
Flow	More	More/High Flow
Flow	Reverse	Reverse Flow
Pressure	More	High Pressure
Pressure	Less	Low Pressure
Temperature	More	High Temperature
Temperature	Less	Low Temperature
Level	More	High Level
Level	Less	Low Level
Utilities	No / Not	Utilities Failure

Figure 2 - Default set of deviations

3.3 Causes & consequences

All potential causes are identified and discussed as the consequences and actions may be different. It is not sufficient to refer to generic causes, e.g. blockage, since the method of prevention and operational issues cannot be adequately defined. The possible causes are within the node (except for nodes at interfaces, battery limit, or start-up of a system). Since a large number of deviations could be developed, only meaningful ones are considered as realistic potential problems and analysed further. All these causes of deviations are recorded whether or not an action is required. Each cause is reviewed and documented individually.

Causes have to be credible, e.g. impact damage from the explosion of the neighbouring vessel is only possible if the vessel contains flammable material or is at great pressure.

For each of the meaningful deviations, the team evaluate all of the consequences of each cause. The consequences are evaluated as assuming no safeguards (which should take place prior to the incident) in place. Safeguards post incident, preventing the escalation of the scenario (e.g. F&G detection, automatic extinguishing system, bund areas, etc.), should nevertheless be considered as being working properly. The role of HAZOP study is to determine the net effect of the potential consequences and the mitigating effect of the safeguards.



4 SIL METHODOLOGY

Based on HAZOP results, a risk assessment with SIL classification was carried out. The Objective of the SIL Assessment is to assign a target Safety Integrity Level (SIL) to each Process Safety Instrumented Function (SIF) according to the international standard IEC 61508 and IEC 61511. This was done using the BUPC risk matrix approach to SIL determination as documented in HAZOP and SIL Study procedure BUSHEHR PETROCHEMICAL COMPANY MEG PLANT ref. [3].

SIL classification is a methodology to assess Safety Integrity Level (SIL) related to safeguarding instruments. The classification of the SIL is done using the Risk Graph method. This method is a qualitative method that enables the SIL rating of a Safety Related System to be determined from knowledge of the risk factors associated with the equipment under control. It can be applied relatively rapid to a large number of functions to eliminate those with little or no safety relevance and highlight those with larger safety relevance.

The result of the risk analysis are given in terms of Safety Integrity Level (SIL), which determine the required technical and organizational measures for the implementation and use of safety instrumented systems.

A Risk Assessment and a determination of the required Safety Integrity Levels of the safety-related systems is to be performed within the hazard and operability (HAZOP) & SIL study.

4.1 SIL allocation study

To assess the risks, HAZOP and SIL Study procedure BUSHEHR PETROCHEMICAL COMPANY MEG PLANT ref. [3]. (see figure 5). All scenarios with hazardous consequences for people, or environmental impact, or Economic loss – identified in the HAZOP study (marked with S, E or L) – are subject to a Risk Assessment and SIL Allocation.

In the case of unmitigated consequences with a severity of C_0 , C_A (in other risk matrices also indicated with $S=S_0$, $S=S_1$, $S=S_2$) are outside the green zone, 1 to 3 additional IPLs must be applied to move with safeguarding into the green zone of the Matrix. Any type of IPL can be applied to reduce the risk.

In the case of unmitigated consequences with a severity of C_B (in other risk matrices also indicated with $S=S_3$) are outside the green zone and 2 instrumentation IPLs must be applied to move with safeguarding into the green zone of the Matrix, at least one instrumentational IPL must be provided in the form of Safety Instrumented Systems (SIS).

In the case of unmitigated consequences with a severity of or C_C , C_D , (in other risk matrices also indicated with $S=S_4$, $S=S_5$,) are outside the green zone and 2, respectively 3 instrumentation IPLs must be applied to move with safeguarding into the green zone of the Matrix, all instrumentational IPL must be provided in the form of Safety Instrumented Systems (SIS).



RISKCONTROL

REP.1189837.01.22

HAZOP & SIL REPORT BUPC MEG PLANT - AIRPACK

Each IPL, as selected from the list of safeguards, is allocated an equivalent SIL. The following list contains examples of IPLs expressed as maximum claimed SIL and have been used as the maximum claimed SIL value throughout the workshop, see figure 6. All safety instrumented systems are valued for the maximum of 1 SIL credit at this stage.

Likelihood Descriptions			Consequence Indices				
			C0	CA	CB	Cc	Cd
Scenario Descriptions	Likelihood Indices		Insignificant	Low	Medium	High	Very High
Expected to occur in the life of this facility	1	Likely	alarp	alarp	alarp	HIGH	HIGH
May occur in the life of this facility	2	Occasional	LOW	alarp	alarp	alarp	HIGH
An event has occurred in Saudi Aramco but not likely in this facility	3	Seldom	LOW	LOW	alarp	alarp	alarp
Some events have occurred in the industry but not likely in this facility	4	Unlikely	LOW	LOW	LOW	alarp	alarp
Rare or never heard of in industry.	5	Remote	LOW	LOW	LOW	LOW	alarp

Figure 3 – Risk Matrix according Hazop & SIL Study Procedure



RISKCONTROL

REP.1189837.01.22

HAZOP & SIL REPORT BUPC MEG PLANT - AIRPACK

Independent Protection Layer (IPL)	Maximum Claimed SIL Value	Remarks
Trip by BPCS	1	
Independent Safety Instrumented System (SIS) SIL 1	1	
Independent Safety Instrumented System (SIS) SIL 2	2	
Independent Safety Instrumented System (SIS) SIL 3	3	
Independent hardwired Safety Instrumented Function (SIF)	As required	
Mechanical Safety Valves	2	
Splash guards at flanges	1	
Operator action by alarm	1	
Rare Mode of Operation	1	
Low Occupancy	1	

Table 5 - Overview of IPL credits

4.2 SIL allocation steps

Select a scenario marked with “E” or “S” or “L” from the HAZOP worksheet.

Describe / explain the safety consequence of the hazard scenario and determine a value from the Risk Matrix, on consequence ranking table.

Discuss/ determine the frequency of the initiating event(s) of the hazard scenario. The frequency of initiating event(s) always must be considered without any available safeguard (protective measure).

The intersection of the selected row (frequency) and column (consequence) will show the resulting value of the risk (required or not SIL).

The team will check if the available safeguards can be used as IPL (independent protection layer). If several safeguards are connected to the basic process control system, only one of these safeguards can be accepted as IPL (except for SIL = a). This fact will consider the possible failure of the basic process control system.

If independent protection layers (IPL) are available, the required SIL (safety integrity level) of the unmitigated scenario can be reduced by each IPL.



RISKCONTROL

REP.1189837.01.22

**HAZOP & SIL REPORT
BUPC MEG PLANT - AIRPACK**

Any factor which may reduce the frequency of the unmitigated consequence shall be listed in the column "SIL Allocation of the HAZOP worksheet.

Only after all mechanical / non-instrumented risk reduction options are exhausted, electrical/electrical/instrumented solutions shall be taken into consideration.

If the required risk reduction factor cannot be achieved by the present safeguards or the required SIL is not practicable, installation of additional safeguards (Safety Instrumented System – SIS) must be considered.



5 CONCLUSION AND RECOMMENDATIONS

5.1 Conclusion

Bureau Veritas would like to highlight the following as noteworthy comments about the HAZOP & SIL study:

- The availability and quality of the documentation for the HAZOP & SIL was sufficient to execute a successful HAZOP & SIL assessment study.
- The availability and quality of the reference documentation for the HAZOP & SIL was sufficient to execute a successful HAZOP & SIL assessment study.
- The expertise and the participation of the HAZOP & SIL team members were sufficient to execute a successful study. Herewith is noted that the assessment is partly executed remotely (End Client/EPC contractor represents) in a so-called SKYPE meeting, and in addition the PID presentation could be followed in the SKYPE meeting. The assessment with SKYPE is experienced as a working alternative compared to a Live HAZOP assessment, which is normally preferred/prescribed.
- The number of recommendations is 4, the proposed design shows suitable for finalizing the detailed engineering phase of the project; the recommendations need to be followed-up during detailed engineering, c.q. closed out correctly before the end of detailed engineering phase.
- The SIL Classification of the Safety Instrumentation Functions (SIF) and the Instrumentation Protection Layers (IPL) as reviewed in the Hazop/SIL sheets is based on the general accepted reduction factors, and are assumed to consist of independent safeguards and only reviewed per cause. The verification of the safeguarding sensors, hardware, safety systems and the final elements (according the success criteria) has to be verified in a separate verification study for all SIFs with SIL classification of SIL 1 and higher, to prove that the required SIL classification is achieved. In this verification all causes and initiating event frequencies have to be implemented. Also the functional test frequencies and the complete hardware test frequencies need to be determined
- As a safety PLC with SIL 2 specification is applied, and all sensors with a HH and LL switch are connected to that safety PLC, all HH and LL switches can be counted as a SIL 1 IPL in SIS. All SIFs with an unmitigated SIL 1 requirement, need to be defined and all defined causes as found in this HAZOP & SIL study need to be validated to determine the demand rate of the SIF (see also table 3).
- The SIFs resulting in a minimum SIL 1 allocation with SIS requirement are listed in table 6 with a reference to the index of referred scenarios. The number of those SIFs are 3 and the number of scenarios is 6 (see also table 3).



RISKCONTROL

REP.1189837.01.22

HAZOP & SIL REPORT BUPC MEG PLANT - AIRPACK

Node	SIF with SIL X Allocation in SIS (sensor name)	Target SIL	Index reference(s) of the scenario (// used as limiter)
01	VT-10151-VAHH	1	01.1.1.1 // 01.1.6.1
02	TIT-10155-TAHH	1	02.1.1.1/2/4 // 02.1.2.1/2/4 // 02.1.3.1/2/4
03	VT-71107-VAHH	1	03.1.1.4.1
04	-	-	-

Table 6 – SIFs with SIL allocation and with index reference(s) of the scenario.



RISKCONTROL

REP.1189837.01.22

**HAZOP & SIL REPORT
BUPC MEG PLANT - AIRPACK**

5.2 Recommendations, close out and actions

A total of 4 actions/recommendations were generated and no issues were noted in a 'Parking Lot'.

Follow-up and close-out of all of these items needs to be undertaken during detailed engineering. Records of the HAZOP & SIL workshop are presented in **Appendix 2**. The HAZOP & SIL recommendations are included in **Appendix 3**. An Excel version of the recommendations and worksheets will also be made available accompanying this document. A reference list of P&ID's and other reference documents is included in **Appendix 4**. The attendance record of all participants is included in **Appendix 5**.

Amersfoort, 10th of May, 2022.
Bureau Veritas Riskcontrol

S. van den Broek
Teamlead HSE services

HAZOP report prepared by: Sjak Rijnaarts
HAZOP report approved by: Tobias Jansen



RISKCONTROL

REP.1189837.01.22

**HAZOP & SIL REPORT
BUPC MEG PLANT - AIRPACK**

6 APPENDICES

Appendices for HAZOP & SIL Report BUPC MEG Plant – Nitrogen and Instrument Air compressor are listed below.

6.1 Appendix 1: Mark-up P&ID's

App 1 Mark-up P&ID's 17811-03A and 03B for HAZOP & SIL study - BUPC MEG Plant – Nitrogen and Instrument Air compressor

6.2 Appendix 2: HAZOP & SIL worksheets

App 2A Hazop & SIL worksheets BUPC MEG Plant HAZOP & SIL study - BUPC MEG Plant – Nitrogen and Instrument Air compressor - pdf
App 2B Hazop & SIL worksheets BUPC MEG Plant HAZOP & SIL study - BUPC MEG Plant – Nitrogen and Instrument Air compressor - excel

6.3 Appendix 3: HAZOP & SIL recommendation list

App 3A Hazop & SIL recommendation list HAZOP & SIL study - BUPC MEG Plant – Nitrogen and Instrument Air compressor - pdf

App 3B Hazop & SIL recommendation list HAZOP & SIL study - BUPC MEG Plant – Nitrogen and Instrument Air compressor - excel

6.4 Appendix 4: Reference P&ID's and reference documents list

App 4 Reference P&ID's and reference documents list HAZOP & SIL study - BUPC MEG Plant – Nitrogen and Instrument Air compressor

6.5 Appendix 5: Attendance record list

App 5 Attendance record list HAZOP & SIL study - BUPC MEG Plant – Nitrogen and Instrument Air compressor

Remark all appendices: In pdf doc type to be viewed by CTRL SHFT A;
in adobe to be opened by Double CLICK on the paperclip OR in other pdf viewers
by Double CLICK on the paperclip at the attachment view

A		B		C		D	
COMPRESSOR		MAIN MOTOR		PULS. DAMPER 1ST STAGE INLET		PULS. DAMPER 1ST STAGE OUTLET	
Tagnumber:	20-C-1002	Tagnumber:	20-C-1002-M	Tagnumber:	20-DC-1002-1	Tagnumber:	20-DC-1002-2
Type:	2-stage oilfree piston	Rated power:	45 kW	Volume:	90L	Volume:	80L
Compressor capacity:	565 Nm ³ /hr	Speed:	1485 rpm	OP / DP:	7 to 9 bar(a) / 13.5 bar(a)	OP / DP:	15.5 bar(a) / 26 bar(a)
Discharge pr. 1st/2nd:	14.5 / 23.5 bar(a)	Power supply:	400 V / 50 Hz / 3 ph	OT / DT:	5 to 55°C / 0 to 80°C	OT / DT:	134°C / 0 to 210°C
Design pr. 1st/2nd:	17 / 25 bar(a)	Nominal current:	TBC	Design:	AMSE VIII. Div. 1	Design:	AMSE VIII. Div. 1
Speed:	400 rpm	Ingress protection:	IP 55	Material:	Carbon steel	Material:	Carbon steel
Discharge temperature:	134°C / 64°C	Hazardous area class:	Ex II 3G IIB T3, Eex'd				
Desing temperaturatue:	170° / 170°C						

GENERAL NOTES	
NOTES :	
1.	All signals mentioned in P&ID will be transferred to FCS via Modbus TCP/IP communication link
2.	CW valve will open on compressor start en close on compressor stop
HOLDS:	
1.	Deleted
2.	Deleted

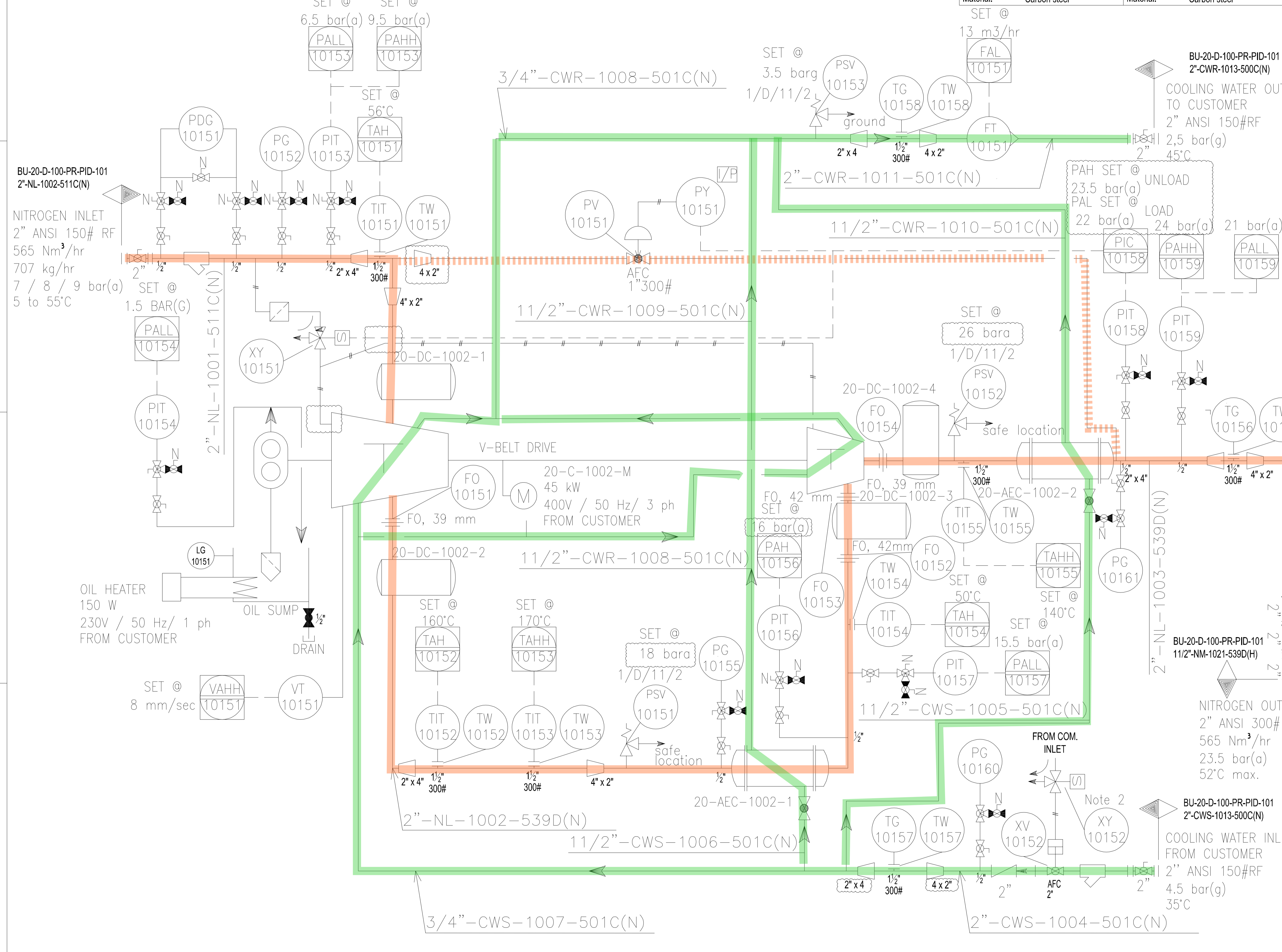

Tie-In-Point :

TP-1: Nitrogen Compressor inlet
 TP-2: Nitrogen Compressor outlet
 TP-3: Main cooling water supply
 TP-4: Main cooling water return

REFERENCE DRAWINGS	DWG.No.
xxxxxxx	xxxxxxx

Node 1: Nitrogen

Node 2: Cooling Water N2 Compressor

REV.	DATE	PURPOSE OF ISSUE (P.O.I)	PREP.	CHKD.	APPR.	AC.
03	09/03/22	For construction	KP	CS	KP	JL
02	03/11/21	For approval	KP	CS	KP	JL
01	09/09/21	For approval	KP	CS	KP	JL

OWNER:

CONTRACTOR:

PROJECT: BUSHEHR PETROCHEMICAL COMPANY MEG PLANT

DRAWING TITLE: 17811-03 P&ID FOR NITROGEN GAS BOOSTER

CONTRACT NO.	SCALE	SIZE	CLASS	PHASE
52-98/445	XX	A0	1	P

DOCUMENT NO.	PROJECT	AREA	PHASE	MRO No.	DIS.	DOC.	SEQ.	SHEET	REV. NO.
	BU	20	VD	303	PR	DWG	0013	1 OF 2	3

A

B

C

D

GENERAL NOTES

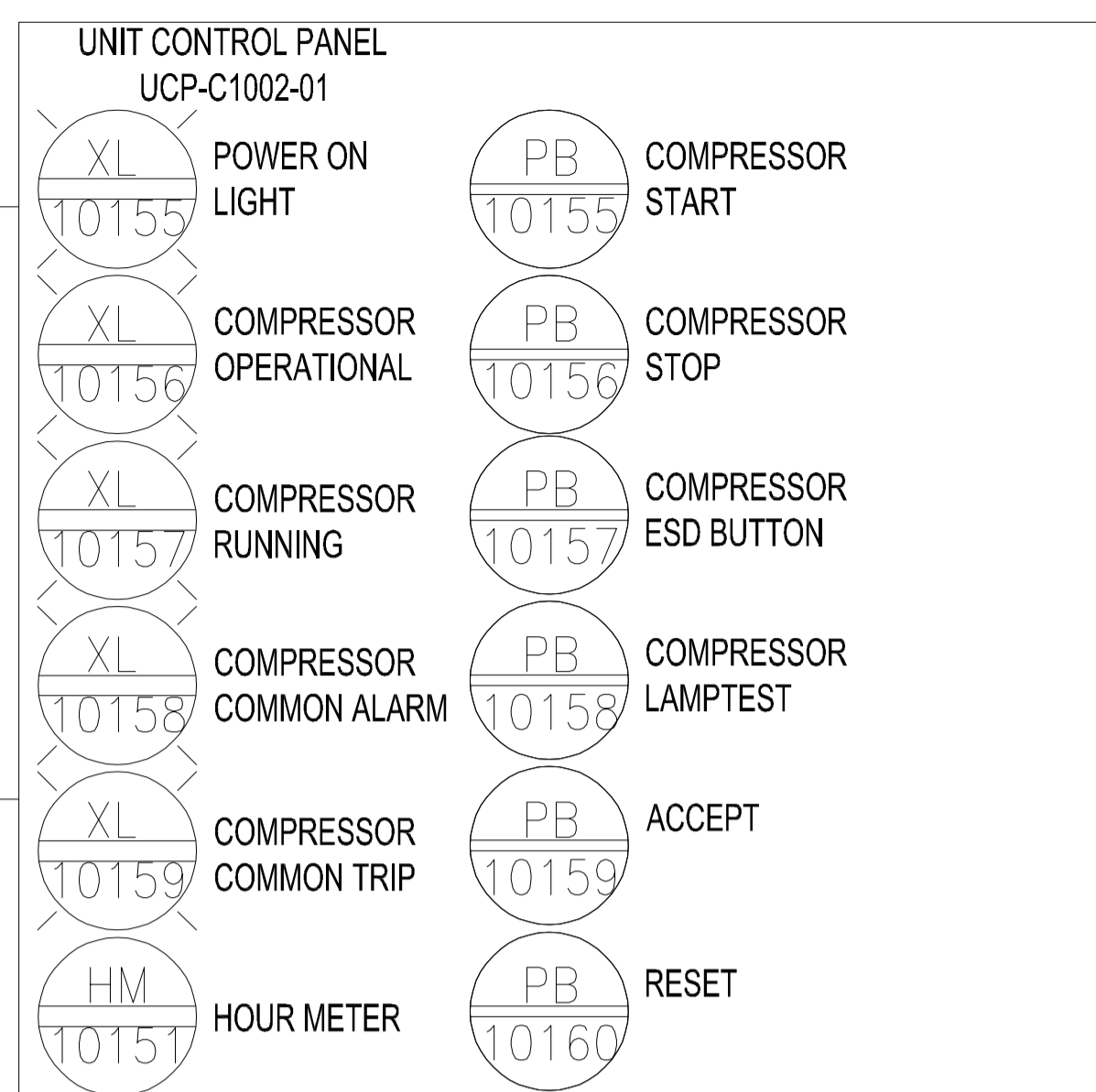
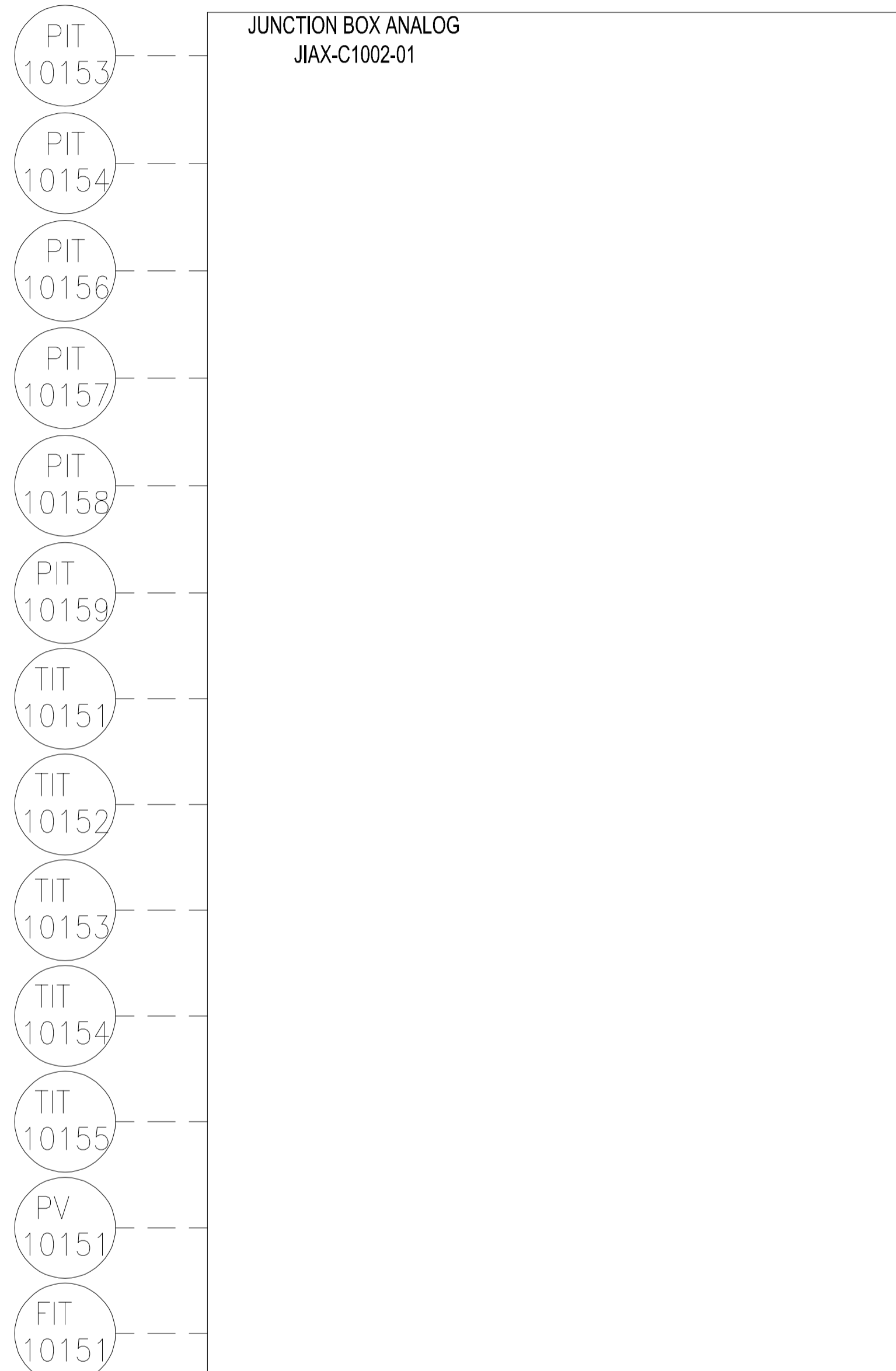
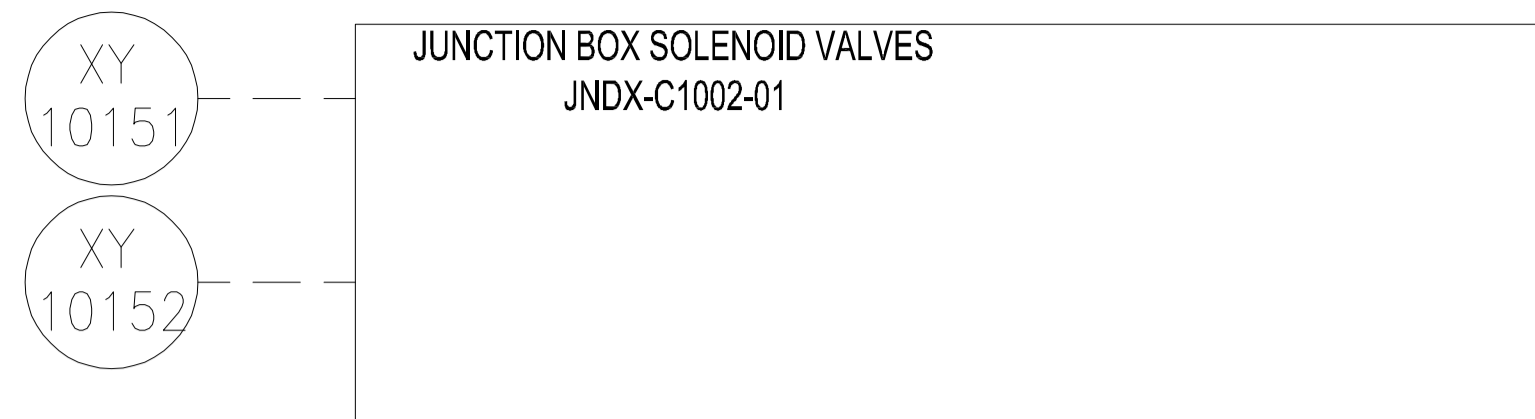

HMI SHOWING

- RUNNING STATUS
- ALARMS AND TRIPS
- P&ID
- PROCESS VALUES

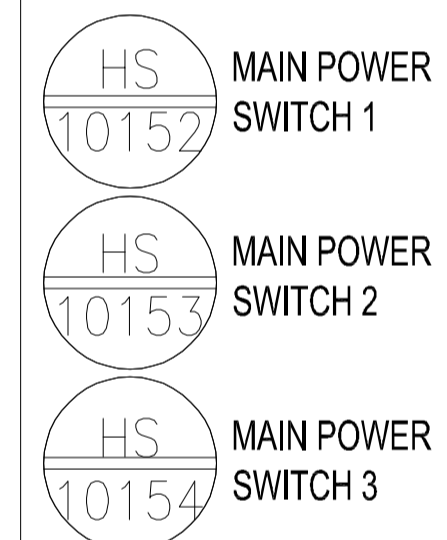

REDUNDANT ETHERNET
MODBUS TCP/IP TO FCS

signals to / from ESD (HWC)
HS-108-SD-1(Emergency Shutdown Command)
XAL-108-2(Common Alarm)

signals from FCS
XCS-108(Time Synchronisation)

MULTICORE CABLE BY CLIENT

SIGNALS TO/FROM DB

- MOTOR RUNNING
- MOTOR FAULT
- MOTOR START / STOP
- HEATER ON/OFF
- HEATER FAULT
- HEATER ON

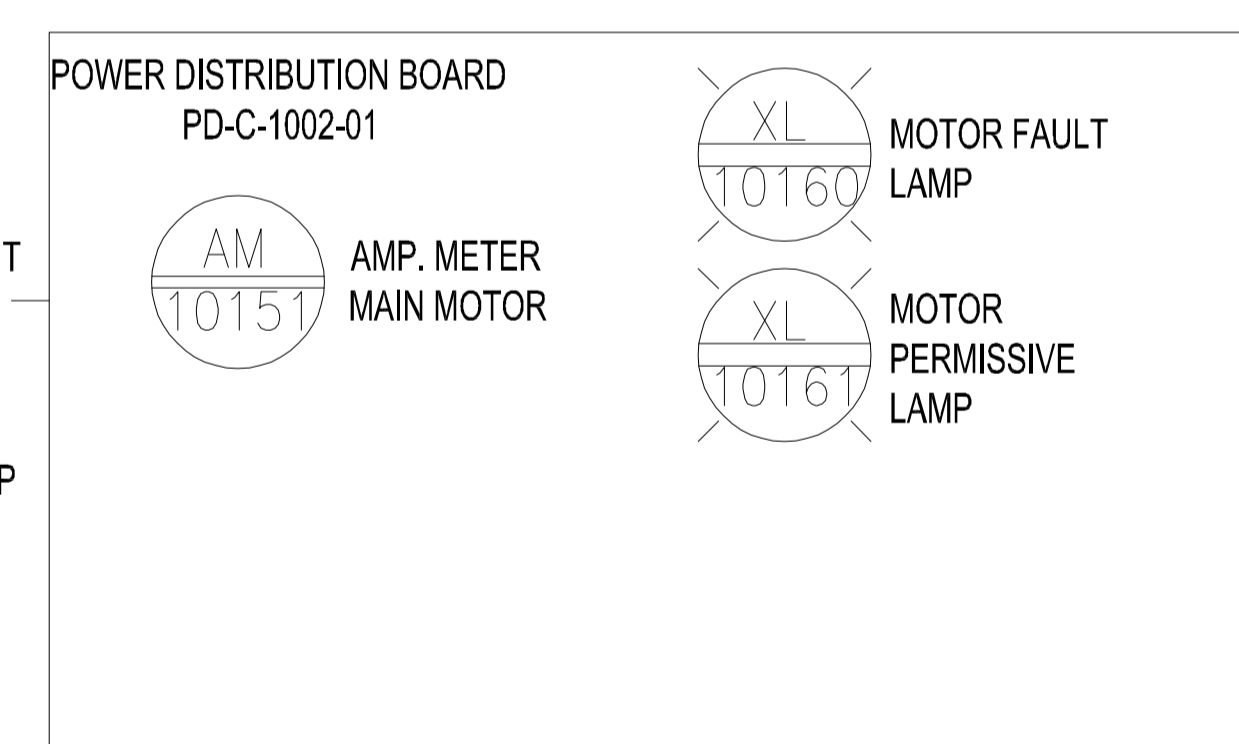

110 VAC, 1PH, 50HZ UPS POWER SUPPLY
110 VAC, 1PH, 50HZ UPS POWER SUPPLY
230VAC, 1PH, 50HZ POWER SUPPLY

400VAC, 3PH, 50HZ POWER SUPPLY
400VAC, 3PH, 50HZ TO MAIN MOTOR
230VAC, 1PH, 50HZ TO HEATER

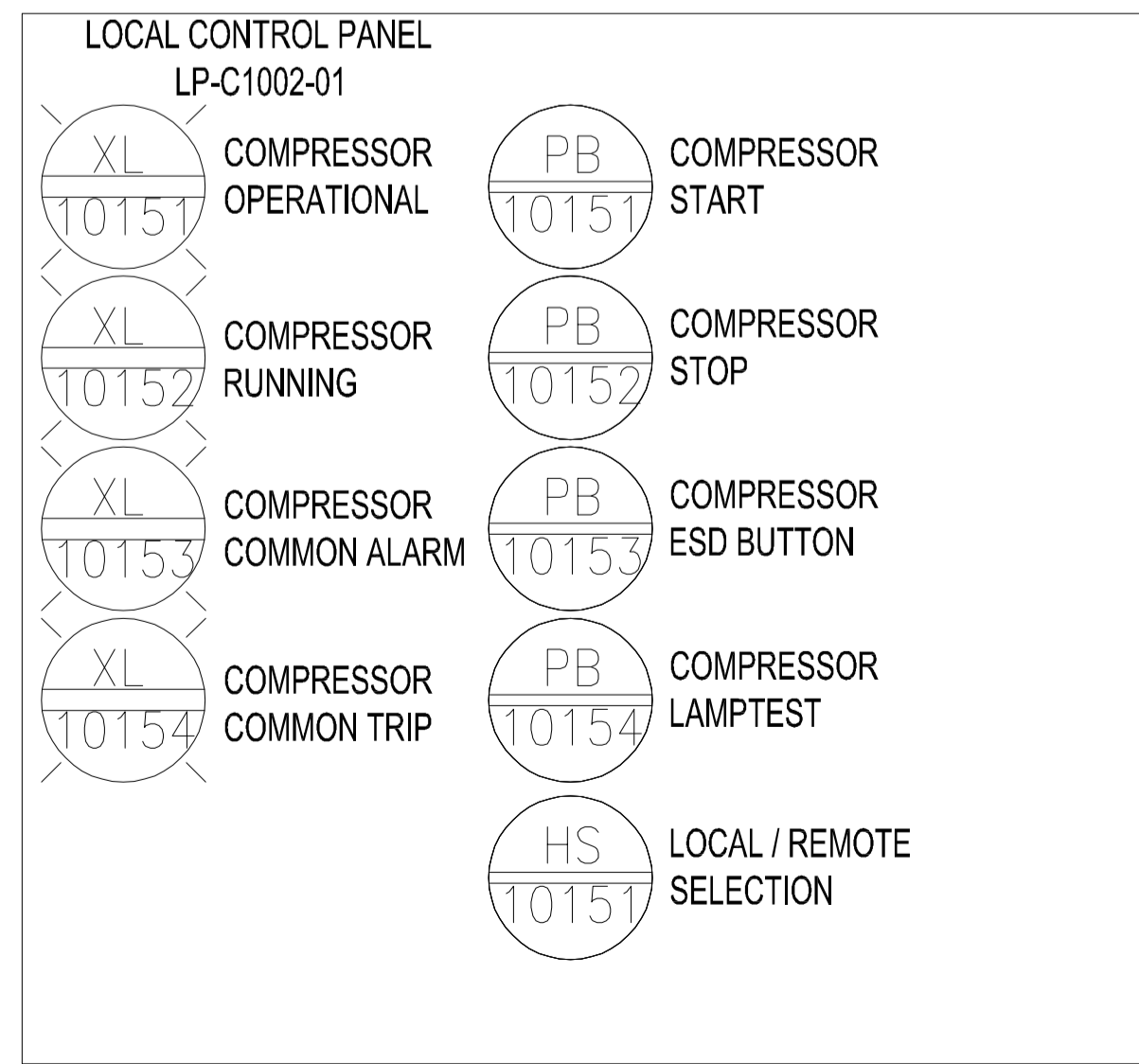

REFERENCE DRAWINGS	DWG.No.
xxxxxxx	xxxxxxx

REV.	DATE	PURPOSE OF ISSUE (P.O.I)	PREP.	CHKD.	APPR.	AC.
03	09/03/22	For construction	KP	CS	KP	JL
02	03/11/21	For approval	KP	CS	KP	JL
01	09/09/21	For approval	KP	CS	KP	JL

OWNER:

MC:

CONTRACTOR:

PROJECT: BUSHEHR PETROCHEMICAL COMPANY
MEG PLANT

DRAWING TITLE:
17811-03 P&ID
NITROGEN COMPRESSOR

CONTRACT NO.	SCALE	SIZE	CLASS	PHASE					
52-98/445	XX	A3	-	-					
DOCUMENT NO.	PROJECT	AREA	PHASE	MRO No.	DIS.	DOC.	SEQ.	SHEET	REV. NO.
-	-	-	-	-	-	-	-	2 OF 2	3

THIS DRAWING IS THE PROPERTY OF AIRPACK AND SHALL NOT BE REPRODUCED OR TRANSMITTED IN ANY FORM OR BY ANY MEANS, ELECTRONIC OR MECHANICAL, WITHOUT THE WRITTEN PERMISSION OF AIRPACK.

COMPRESSOR	MAIN MOTOR	PULSATION DAMPER INLET	PULSATION DAMPER OUTLET	AFTER COOLER
Tagnumber: 20-C-7080 Type: 1-stage oilfree piston Compressor capacity: 173 Nm ³ /hr Operating pressure: 21 bar(a) Design Pressure: 26 bar(g) Speed: 400 rpm Discharge temperature: 180°C	Tagnumber: 20-C-7080-M Rated power: 15 kW Speed: 1475 rpm Power supply: 400 V/ 50 Hz/ 3 ph Rated current: 28.5 Ingress protection: IP 55 Hazardous area class: Ex II 3G IIB T3, Eex'd'	Tagnumber: 20-DC-7080-1 Volume: 30L OP / DP: 7 to 8.5 bar(a) / 13.5 bar(a) OT / DT: 5 to 55°C / 0 to 80°C Design: AMSE VIII. Div. 1 Material: Carbon steel	Tagnumber: 20-DC-7080-2 Volume: 30L OP / DP: 21 bar(a) / 25 bar(a) OT / DT: 180 °C / 0 to 210°C Design: AMSE VIII. Div. 1 Material: Carbon steel	Tagnumber: 20-AEC-7080-1 Flow air side: 173 Nm ³ /hr Flow water side: 1.4 m ³ /hr OP / DP(shell): 21 bar(a) / 25 bar(g) OP / DP(tubes): 4.5 bar(g) / 10 bar(g) OT / DT(shell): 180°C / 0 to 210°C OT / DT(tubes): 35 °C / 0 to 95°C Design: TEMA C, AMSE VIII. Div. 1 Material: Carbon steel

GENERAL NOTES

NOTES:

- This line is to recycle the flow that is not required to go into the system any additional flow is recycled to the inlet based on pressure setting on PIT-71107
- FO (orifice) have been added based on preliminary pulsation study
- Compressor starts by means of PIT-71107 low pressure and stops by means on PIT-71107 high pressure

HOLDS:

- Deleted

Tie-In-Point :

TP-1: Instrument air compressor inlet
TP-2: Instrument air compressor outlet
TP-3: Main cooling water supply
TP-4: Main cooling water return

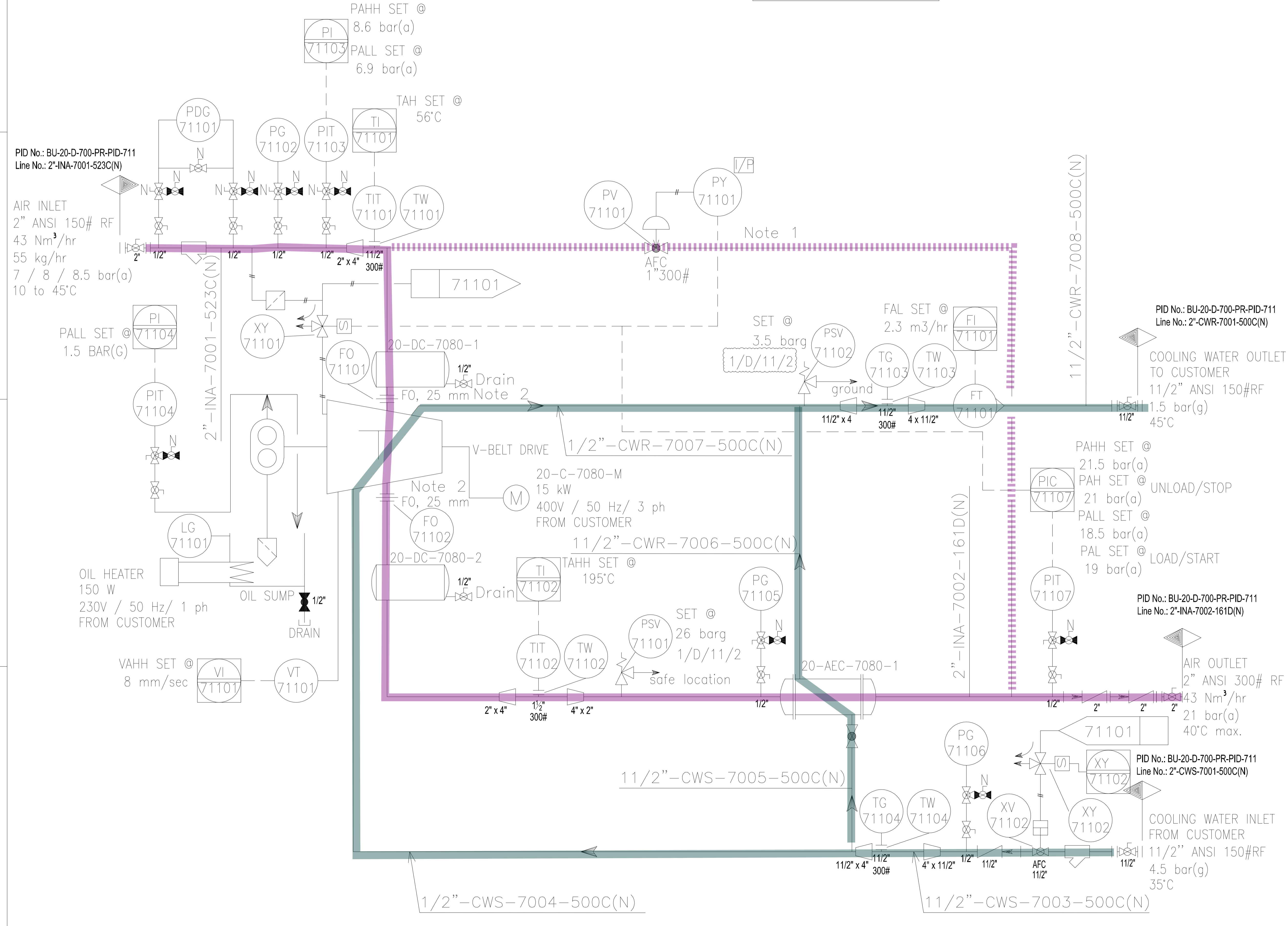

REFERENCE DRAWINGS	DWG.No.
xxxxxxx	xxxxxxx

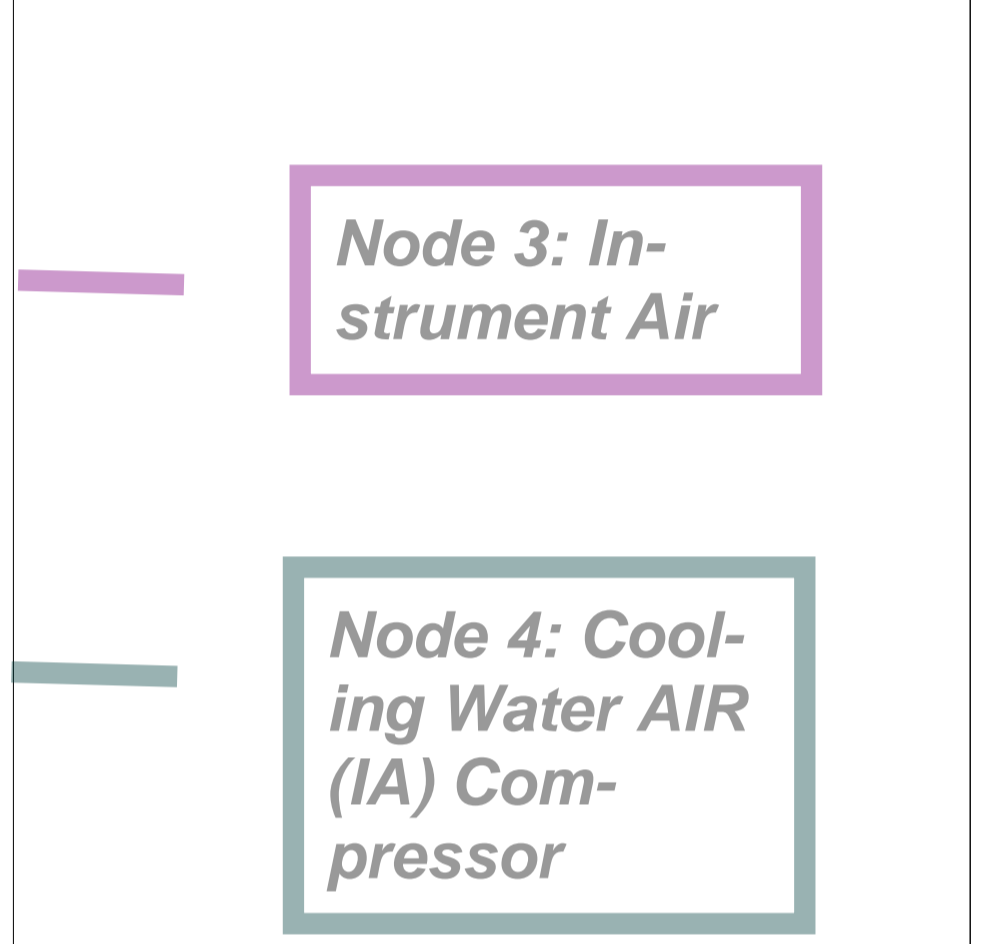

REV	DATE	PURPOSE OF ISSUE (P.O.I)	PREP	CHKD	APPR	AC
05	31/01/21	Approved For construction	KP	CS	KP	JL
04	07/01/21	Approved For construction	KP	CS	KP	JL
03	09/12/21	For construction	KP	CS	KP	JL
02	04/12/20	For approval	KP	CS	KP	JL
01	04/12/20	For approval	KP	CS	KP	JL
00	20/10/20	For approval	KP	CS	KP	JL

OWNER:

MC:

CONTRACTOR:

PROJECT: BUSHEHR PETROCHEMICAL COMPANY MEG PLANT

DRAWING TITLE: 17811-03 P&ID FOR INSTRUMENT AIR COMPRESSOR

CONTRACT NO.	SCALE	SIZE	CLASS	PHASE
52-98/445	XX	A0	1	P

DOCUMENT NO.	PROJECT	AREA	PHASE	MRQ No.	DIS.	DOC.	SEQ.	SHEET	REV. NO.
	BU	20	VD	303	FR	DWG	0066	1 OF 2	03

THIS DRAWING IS THE PROPERTY OF AIRPACK AND MUST BE HELD IN CONFIDENCE. NO REPRODUCTION OR OTHER USE OF THE DOCUMENT IN WHOLE OR IN PART IS PERMITTED WITHOUT THE PRIOR CONSENT OF AIRPACK.

A

B

C

D

GENERAL NOTES

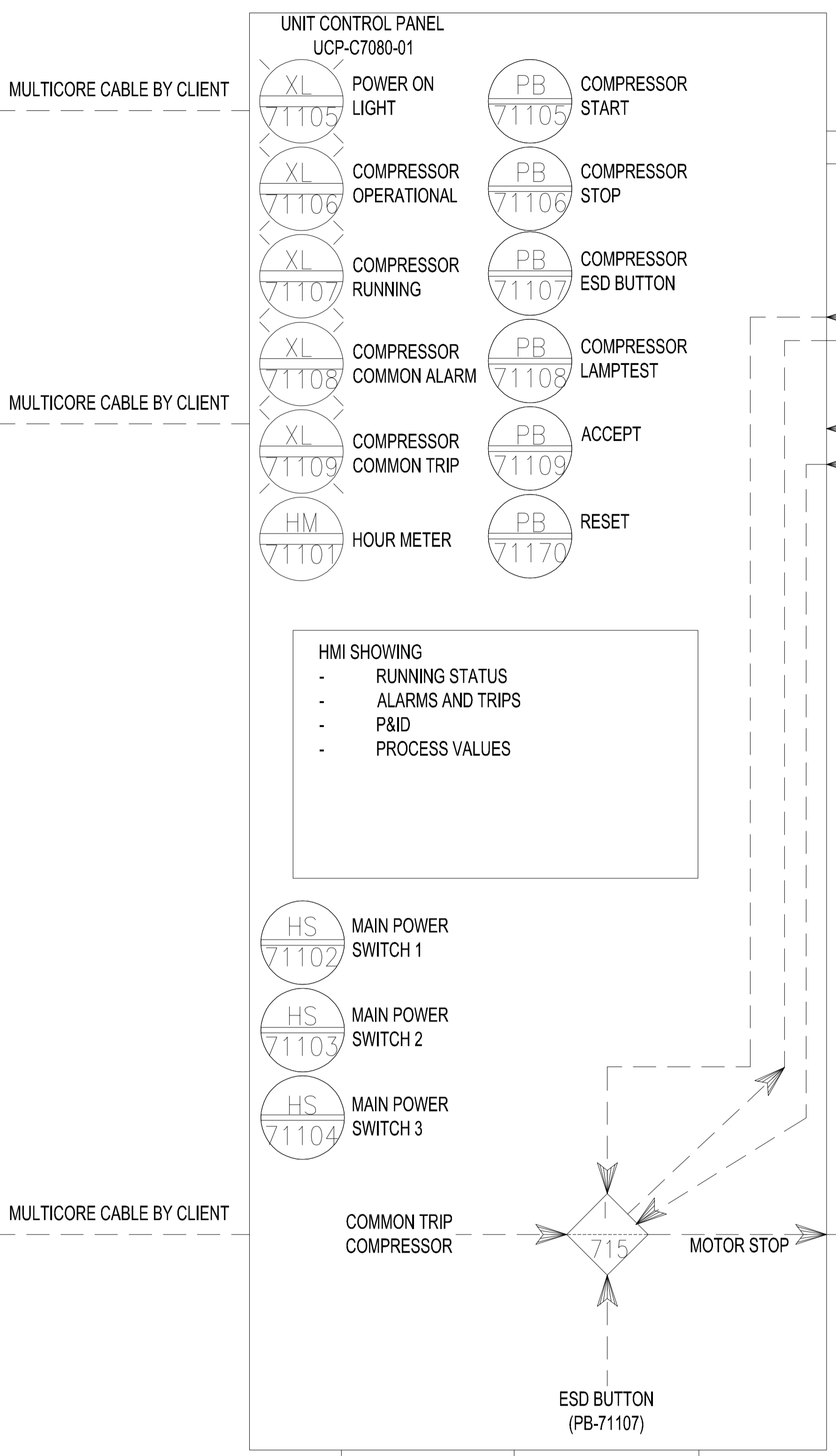
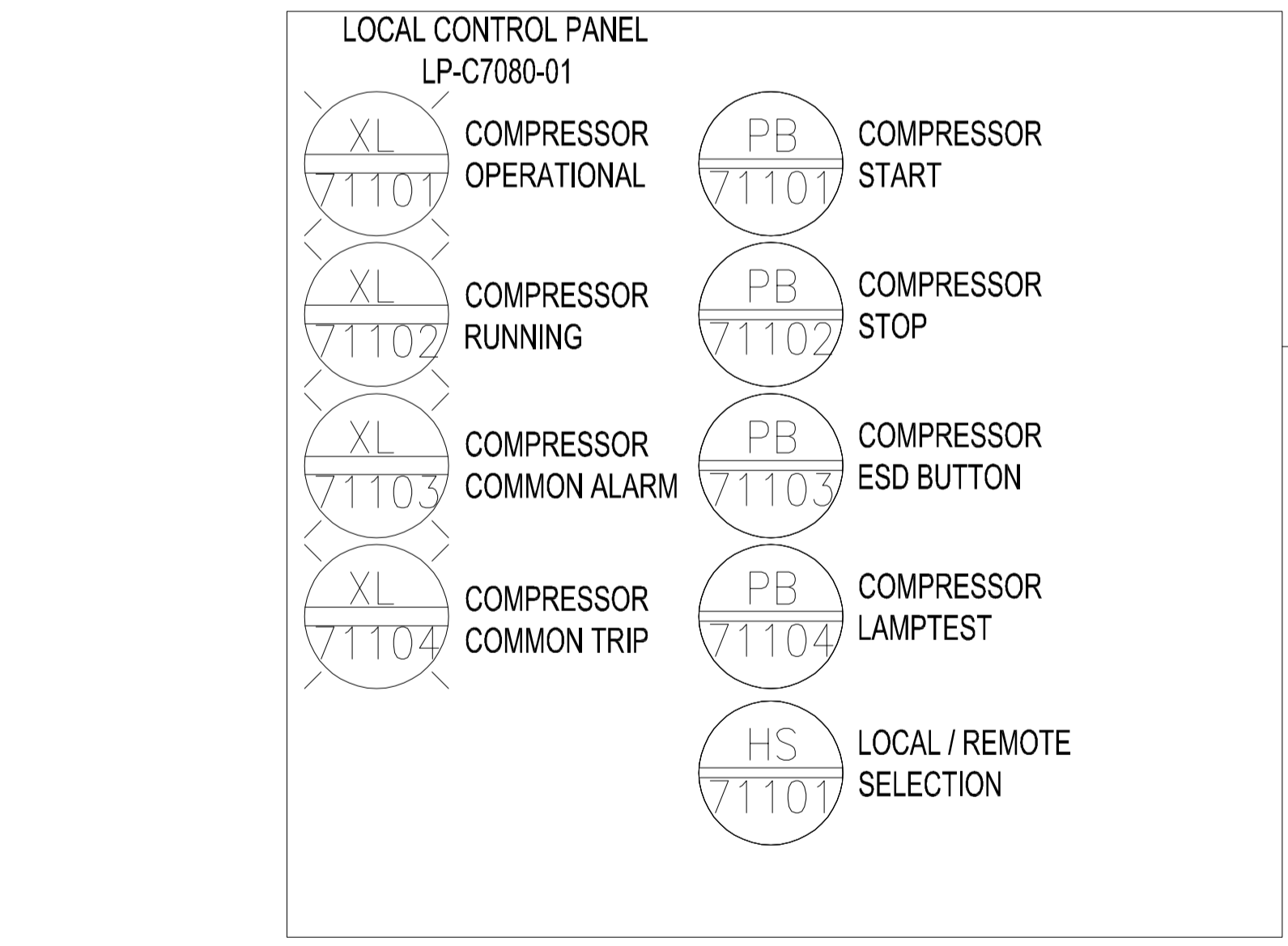
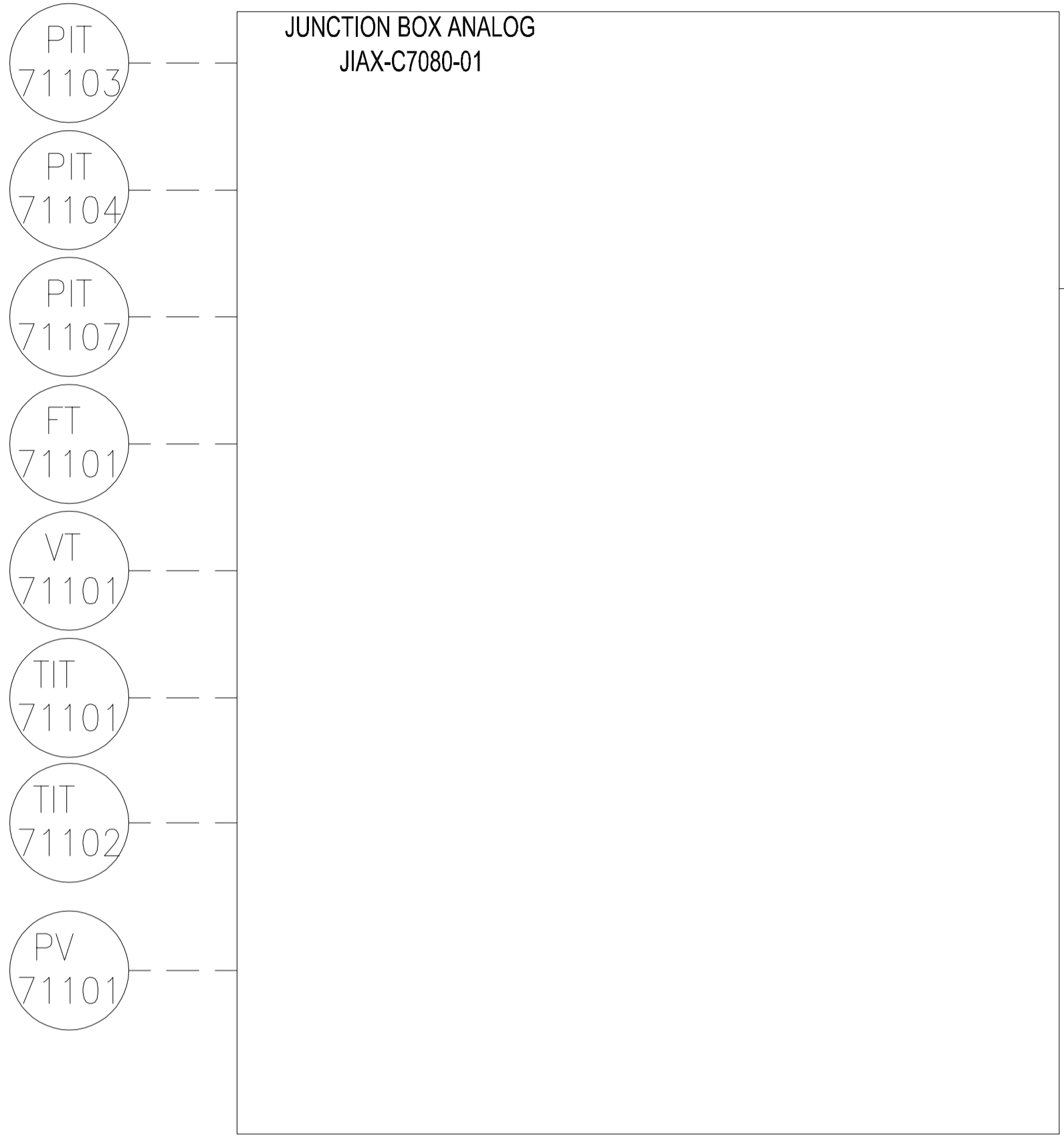
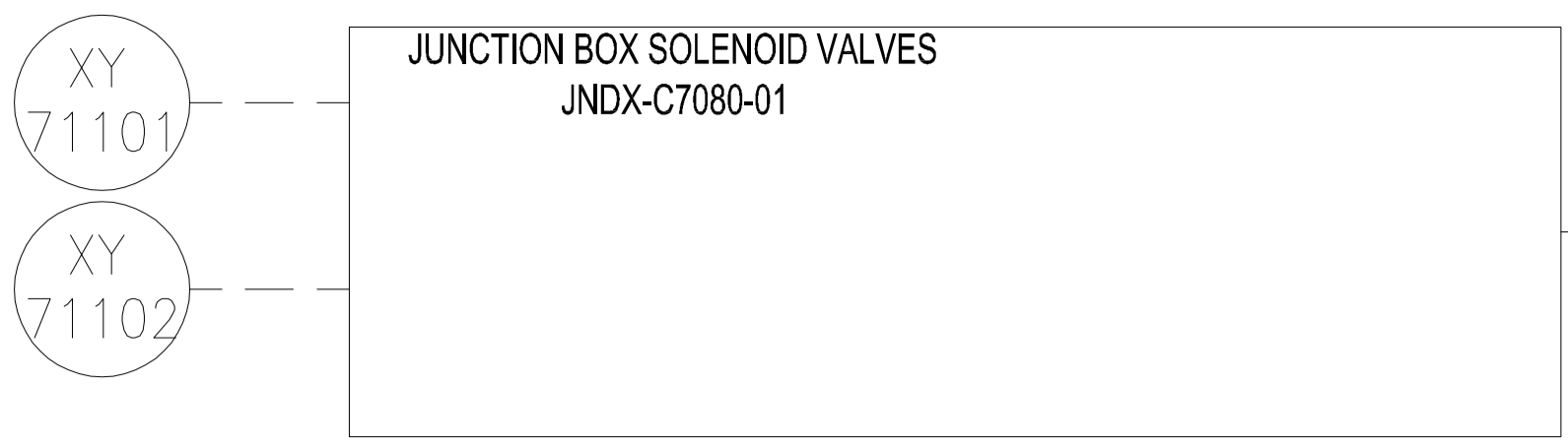

110 VAC, 1PH, 50HZ UPS POWER SUPPLY 110 VAC, 1PH, 50HZ UPS POWER SUPPLY 230VAC, 1PH, 50HZ POWER SUPPLY

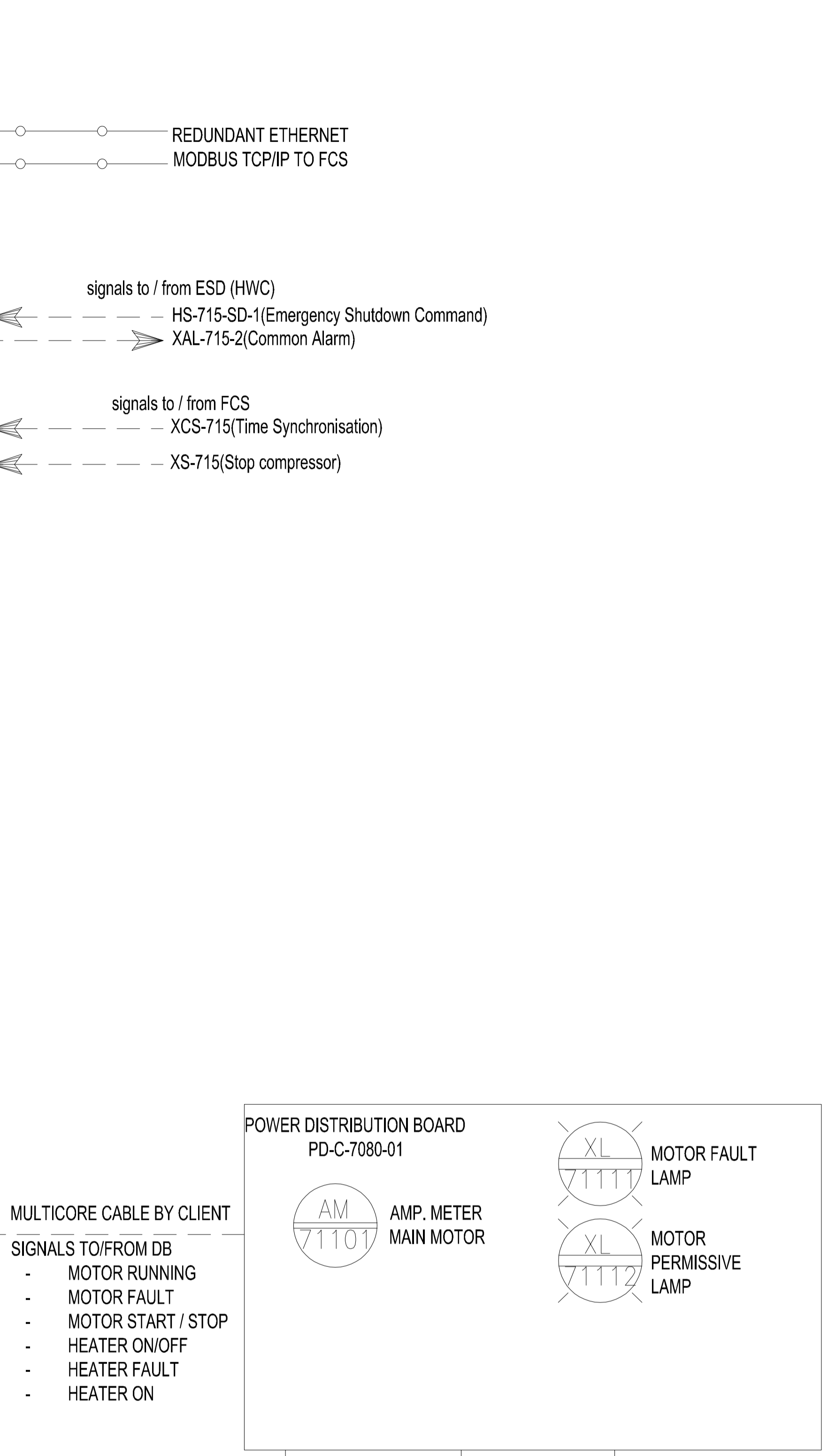

400VAC, 3PH, 50HZ POWER SUPPLY 400VAC, 3PH, 50HZ TO MAIN MOTOR 230VAC, 1PH, 50HZ TO HEATER

REDUNDANT ETHERNET
MODBUS TCP/IP TO FCS

signals to / from ESD (HWC)
 - HS-715-SD-1(Emergency Shutdown Command)
 - XAL-715-2(Common Alarm)

signals to / from FCS
 - XCS-715(Time Synchronisation)
 - XS-715(Stop compressor)

SIGNALS TO/FROM DB
 - MOTOR RUNNING
 - MOTOR FAULT
 - MOTOR START / STOP
 - HEATER ON/OFF
 - HEATER FAULT
 - HEATER ON

REFERENCE DRAWINGS	DWG.No.
xxxxxxx	xxxxxxx

REV	DATE	PURPOSE OF ISSUE (P.O.I)	PREP	CHKD	APPR	AC
05	31/01/21	Approved For construction	KP	CS	KP	JL
04	07/01/21	Approved For construction	KP	CS	KP	JL
03	09/12/21	For construction	KP	CS	KP	JL
02	04/12/20	For approval	KP	CS	KP	JL
01	04/12/20	For approval	KP	CS	KP	JL
00	20/10/20	For approval	KP	CS	KP	JL

OWNER:

MC:

CONTRACTOR:

PROJECT: BUSHEHR PETROCHEMICAL COMPANY
MEG PLANT

DRAWING TITLE:
17811-03 P&ID FOR
INSTRUMENT AIR COMPRESSOR

CONTRACT NO.	SCALE	SIZE	CLASS	PHASE					
52-98/445	XX	A0	1	P					
DOCUMENT NO.	PROJECT	AREA	PHASE	MRQ No.	DIS.	DOC.	SEQ.	SHEET	REV. NO.
	BU	20	VD	303	FR	DWG	0066	2 OF 2	04
OWNER DOC. NO.:	BU	20	VD	303	FR	DWG	0066	2 OF 2	04

THIS DRAWING IS THE PROPERTY OF AIRPACK AND MUST BE HELD IN CONFIDENCE. NO REPRODUCTION OR OTHER USE OF THIS DOCUMENT IS PERMITTED WITHOUT THE PRIOR WRITTEN CONSENT OF AIRPACK.

Bureau Veritas Riskcontrol The Netherlands B.V.



RISKCONTROL

Client: AIRPACK

BV Project Title: BUPC MEG PLANT HAZOP & SIL study
DD - Compressors

BV Project Reference: 17811-OO-0703

**This workbook is an accurate record of the discussion with the client and does not represent Bureau Veritas opinion on the subject.*

Rev	Date	Person(s) responsible	Subject of the revision
0	26-04-2022	S. Rijnaarts	First Issue

HAZOP WORKSHEET: Nitrogen

[Index](#)

Node Index: 01

Title: Nitrogen

Drawings: 17811-03A-001

17811-03A-002

Node Details:

Equipment:
 -20-C-1002 Nitrogen Compressor
 -20-DC-1002-1 Pulse Damper 1st stage inlet
 -20-DC-1002-2 Pulse Damper 1st stage discharge
 -20-AEC-1002-1 Intercooler
 -20-DC-1002-3 Pulse Damper 2nd stage inlet
 -20-DC-1002-4 Pulse Damper 2nd stage discharge
 -20-AEC-1002-2 Aftercooler

For consequences of Economics (Asset Damage/Loss) (L); Downtime Loss is not estimated, Only Asset REPAIR costs.
 The following conversion for consequences is followed related to the Risk Matrix in the Hazop Procedure Manual:
 S1= C_A (minor); S2= C_B (serious)

Date: 19.04.2022

Session: Morning

Attendees: Sjak Rijnaarts
 Dzenita Damjanovic
 Kevin Pool
 Jeroen Rust
 Brice Kpozuxe
 Nikan Shahidinia
 Mr. Abedi
 Ms. Techrançi
 Mr. Hasemi
 Ms. Khakpur
 Mr. Najmeddin
 Ms. Nazanin Malekinia

[Index](#)

INDEX	PARAMETER	GUIDEWORD	DEVIATION	CAUSE	CONSEQUENCE	CAT	SAFEGUARDS	Unmitigated RISK			IPLs	SIL	RECOMMENDATIONS / ACTIONS	ACTION OWNER
								C	F	SIL				
01.1.1.1	Flow	No / Not	No/Less Flow	No nitrogen supply from Plant	1. No Supply to the compressor leading to underpressure at the suction side of the compressor. Worst case is if recycle line is closed. No vacuum is expected, however the 1stage discharge pressure will decrease. Increase of temperature of the second stage exceeding the design temperature of the Compressor. Less supply to the end users. Vibrations of the axis of the compressor is possible. No loss of containment. No hazardous consequence. Asset damage (L) only 2nd stage < 5000 US\$.	L	1. PIT-10153-PALL to Trip 20-C-1002 (UCP ESD) 2. PIT-10159-PALL to Trip 20-C-1002 (UCP ESD) 3. TIT-10155-TAHH to trip 20-C-1002 (UCP ESD)	1	3	SIL 0	1. PIT-10153-PALL to Trip 20-C-1002 (UCP ESD) 2. PIT-10159-PALL to Trip 20-C-1002 (UCP ESD) 3. TIT-10155-TAHH to trip 20-C-1002 (UCP ESD)	3	No action	
01.1.2.1	Flow	No / Not	No/Less Flow	Blocked Filter/Strainer in supply line (inlet)	1. No Supply to the compressor leading to underpressure at the suction side of the compressor. Worst case is if recycle line is closed. No vacuum is expected, however the 1stage discharge pressure will decrease. Increase of temperature of the second stage exceeding the design temperature of the Compressor. Less supply to the end users. Vibrations of the axis of the compressor is possible. No loss of content. No hazardous consequence. Asset damage (L) only 2nd stage < 5000 US\$.		1. PIT-10153-PALL to Trip 20-C-1002 (UCP ESD) 2. PIT-10159-PALL to Trip 20-C-1002 (UCP ESD) 3. TIT-10155-TAHH to trip 20-C-1002 (UCP ESD)	1	3	SIL 0	1. PIT-10153-PALL to Trip 20-C-1002 (UCP ESD) 2. PIT-10159-PALL to Trip 20-C-1002 (UCP ESD) 3. TIT-10155-TAHH to trip 20-C-1002 (UCP ESD)	3	No action	
01.1.3.1	Flow	No / Not	No/Less Flow	Motor or V-belt Drive Failure Compressor 20-C-1002-M	1. No Supply to the end user. Discharge pressure of the Compressor will decrease. No supply to the end users. No hazardous consequence. No asset consequences		1. PIT-10159-PALL to Trip 20-C-1002 (UCP ESD) 2. PIT-10154-PALL to Trip 20-C-1002 (UCP ESD) (lube oil pressure low will stop the compressor)							
01.1.4.1	Flow	No / Not	No/Less Flow	Mechanical Failure 1st stage Compressor 20-C-1002	1. Worst case is piston failure. No Supply to the end user. Loss of containment is possible. Maximum release < 0.2 kg/h (707 kg/h /) No suffocation to people is expected (open area, 4 sides open). Compressor may catch fire, damage of compressor. Hurting people is possible. Severity S=S2; S2 is equal to C A. Asset damage (L) is ca. 50 k. US\$ L=S1; Most severe is people risk. Note: Regular maintenance will reduce this risk.	S	1. PIT-10159-PALL to Trip 20-C-1002 (UCP ESD) 2. VT-10151-VAHH to Trip 20-C-1002 (UCP ESD)	2	3	SIL 1	1. PIT-10159-PALL to Trip 20-C-1002 (UCP ESD) 2. VT-10151-VAHH to Trip 20-C-1002 (UCP ESD) SIL1 SIF in SIS	2	No action	
01.1.5.1	Flow	No / Not	No/Less Flow	Partial Blockage inside the shell of the Intercooler 20-AEC-1002-1 Gas side (Gas is going through the shell)	1. Increased pressure drop over the intercooler and increase of temperature in the outlet of the intercooler and the inlet of the 2nd stage. Exceeding of the design temperature in the discharge of the 2nd stage of the compressor. No loss of containment. No hazardous consequence. Asset damage (L) only 2nd stage < 5000 US\$. IEF=0.01	L	1. PIT-10159-PALL to Trip 20-C-1002 (UCP ESD) 2. TIT-10155-TAHH to trip 20-C-1002 (UCP ESD) 3. TIT-10154-TAH to trip 20-C-1002 by operator	1	2	No action		3	No action	

01.1.6.1	Flow	No / Not	No/Less Flow	Mechanical Failure 2nd stage Compressor 20-C-1002	1. Worst case is piston failure. No Supply to the end user. Loss of containment is possible. Maximum release < 0.2 kg/h (707 kg/h /) No suffication to people is expected (open area, 4 sides open). Compressor may catch fire, damage of compressor. Hurting people is possible. Severity S=S2 S2 is equal to C A. Asset damage (L) is ca. 50 k. US\$ S=S1; Most severe is people risk. Note: Regular maintenance will reduce this risk.	S	1. PIT-10159-PALL to Trip 20-C-1002 (UCP ESD) 2. VT-10151-VAHH to Trip 20-C-1002 (UCP ESD)	2	3	SIL 1	1. PIT-10159-PALL to Trip 20-C-1002 (UCP ESD) 2. VT-10151-VAHH to Trip 20-C-1002 (UCP ESD) SIL1 SIF in SIS	2	No action	
01.1.7.1	Flow	No / Not	No/Less Flow	Partial Blockage of shell of the aftercooler 20-AEC-1002-2 Gas side (Gas is going through the shell)	1. Increased pressure drop over the aftercooler and increase of temperature in the outlet of the aftercooler and in the discharge of the 2nd stage of the compressor. Exceeding of the design temperature in the discharge of the 2nd stage of the compressor (upstream aftercooler). No loss of containment. No hazardous consequence. Asset damage (L) only 2nd stage < 5000 US\$. IEF=0.01. Downstream is possibly consequences for high temperature.	L	1. PIT-10159-PALL to Trip 20-C-1002 (UCP ESD) 2. TIT-10155-TAHH to trip 20-C-1002 (UCP ESD)	1	2	No action		No action	1. Ensure that high temperature discharge from the nitrogen compressor is evaluated in the Hazop of the Plant. Maximum temperature downstream should be safeguarded on 95 deg. C (based on setting of the PSV-10152).	
01.1.8.1	Flow	No / Not	No/Less Flow	Blocked flow by check valves at outlet fails closed, also in case of lower pressure downstream.	1. No supply to the end user. Increased pressure and temperature in the second stage of the compressor. Flow will be recycled to the inlet. Recycle line will be designed for full flow. No consequences.		1. PIT-10159-PAHH to trip 20-C-1002 (UCP ESD) 2. PSV-10152 @ 26 bara 3. TIT-10155-TAHH to trip 20-C-1002 (UCP ESD)							
01.1.9.1	Flow	No / Not	No/Less Flow	Blocked flow downstream (no take off)	1. No supply to the end user. Increased pressure and temperature in the second stage of the compressor. Flow will be recycled to the inlet. Recycle line will be designed for full flow. No consequences.		1. PIT-10159-PAHH to trip 20-C-1002 (UCP ESD) 2. PSV-10152 @ 26 bara 3. TIT-10155-TAHH to trip 20-C-1002 (UCP ESD)							
01.1.10.1	Flow	No / Not	No/Less Flow	Less/No flow over recycle line by 'Fail Closed AFC PV-10151 or control failure to closed valve in case AFC should be NOT fully closed.	1. Increased pressure and temperature in the second stage of the compressor. Exceeding of the design temperature in the discharge of the 2nd stage of the compressor. No loss of containment. No hazardous consequence. Asset damage (L) only 2nd stage < 5000 US\$. IEF=0.1	L	1. PIT-10159-PAHH to trip 20-C-1002 (UCP ESD) 2. PSV-10152 @ 26 bara 3. TIT-10155-TAHH to trip 20-C-1002 (UCP ESD)	1	3	SIL 0	1. PIT-10159-PAHH to trip 20-C-1002 (UCP ESD) . 2. PSV-10152 @ 26 bara 3. TIT-10155-TAHH to trip 20-C-1002 (UCP ESD)	4	No action	
01.1.11.1	Flow	No / Not	No/Less Flow	No lube oil flow by filter blockage or Pump failure to compressor	1. Overheating of the bearings in case of long term reduced flow. Asset damage (L) of the bearings of the compressor; < 5000 US\$. IEF=0.1	L	1. PIT-10154-PALL to trip 20-C-1002 (UCP ESD) .	1	3	SIL 0	1. PIT-10154-PALL to trip 20-C-1002 (UCP ESD) .	1	No action	
01.2.1.1	Flow	More	More/High Flow	More flow over the recycle line by 'Fail Opened AFC PV-10151 or control failure to opened valve in case AFC should be NOT fully opened.	1. Decreased pressure and temperature in the second stage of the compressor. Less supply to the plant/ end user. No hazardous consequence; No asset consequence.		1. PIT-10159-PALL to trip 20-C-1002 (UCP ESD)							
01.4.1.1	Pressure	More	High Pressure	No additional scenarios identified.	See also no flow scenarios									
01.5.1.1	Pressure	Less	Low Pressure	No additional scenarios identified.	See also no flow scenarios									
01.6.1.1	Temperature	More	High Temperature	High Lube oil Temperature during stop compressor by control failure oil heater .	Increased temperature, however not exceeding the ignition temperature/flash point of the lube oil, also not exceeding the design temperature of sump or lube oil system. Less lubrication during the start because of lower viscosity. Pressure in the lube oil system will also decrease. No overheating of the heater, because it is a submerged system. No hazardous consequences, no asset consequences.		1. 'PIT-10154 to trip the 20-C-1002 (UCP ESD), no successful safeguard because the heater is only operating during compressor stop. 2. Heater is self limiting with higher temperature.							
01.6.2.1	Temperature	More	High Temperature	No additional scenarios identified.	See also no flow scenarios and no flow scenarios node 02									
01.7.1.1	Temperature	Less	Low Temperature	Low Lube oil Temperature at start by failure oil heater or control failure oil heater .	At lower temperature (ambient) the compressor will operate with sufficient lubrication. No consequences. Note: after startup fast warming up of the lube oil is achieved.		No consequences, because compressor is designed for lube oil at ambient conditions							
01.8.1.1	Level	More	High Level	Not applicable in this node.										
01.9.1.1	Level	Less	Low Level	Not applicable in this node.										
01.10.1.1	Utilities	No / Not	Utilities Failure	No additional scenarios identified.	At power failure all valves will go to the safe position.									
01.15.1.1			Contamination	Not applicable in this node.										
#N/A														
#N/A														
#N/A														
#N/A														
#N/A														

02.1.1.4	Flow	No / Not	No/Less Flow	No Cooling Water supply from Plant	Overheating of cooling water in aftercooler 20-AEC-1002-2. Exceeding of the design temperature of the tubes inside the aftercooler (95 deg C). Maximum temperatures of the cooling water (140 deg C -equal to uncooled nitrogen- can be reached. Boiling of water may start at ca. 120 deg C. Tube rupture is possible. Nitrogen induced into the cooling water and exceeding also the design pressure of the cooling water system. Loss of containment is possible. Maximum release with full rupture- 0.2 kg/s (707 kg/h /). Full rupture is not expected. No suffocation of people is expected (open area, 4 sides open). Remote suffocation risk to people is possible (safety distance is ca. 1-2 meters. Severity S=S2 (S2 is equal to C A according risk matrix) Asset damage (L) is ca. 10 k. US\$ L=S1; Most severe risk is people risk (S=S2).	S	1. TIT-10155-TAHH to Trip 20-C-1002 (UCP ESD) 2. FT-10151-FAL to Trip 20-C-1002 by operator (only 1 alarm is counting for a risk reduction) 3. PSV-10153 @3.5 barg to ground	2	3	SIL 1	1. TIT-10155-TAHH to Trip 20-C-1002 (UCP ESD) <i>SIL 1 SIF in SIS</i> 2. FT-10151-FAL to Trip 20-C-1002 by operator (only 1 alarm is counting for a risk reduction) 3. PSV-10153 @3.5 barg to ground (RRF=100)	4	No action		
02.1.1.5	Flow	No / Not	No/Less Flow	No Cooling Water supply from Plant	No Cooling of Compressor 20-C-1002. Not exceeding of the design temperature (170 deg C for valves, 210 deg C for casing and internal cooling water circuit); temperature in the discharge of the 1st stage or 2nd stage of the compressor may go up ca. 170 deg C. No loss of containment. No hazardous consequence. No Asset damage (L) is expected.		1. TIT-10155-TAH to Trip 20-C-1002 (UCP ESD) 2. FT-10151-FAL to Trip 20-C-1002 (UCP ESD)								
02.1.2.1	Flow	No / Not	No/Less Flow	No Cooling Water by fail closed of XV-10152	No Cooling of nitrogen in intercooler 20-AEC-1002-1. IEF=0.1. Not exceeding of the design temperature (210 deg C) in the discharge of the 2nd stage of the compressor (may go up 204 deg C). Possibly max temperature (140 deg C) exceeding the design temperature (80 deg C) of the inlet pulse damper 20-DC-1002-3. Maximum release with full rupture- 0.2 kg/s (707 kg/h /). Open area, 4 sides open. Remote suffocation risk to people is possible (safety distance is ca. 1-2 meters). Severity S=S2 (S2 is equal to C A according risk matrix); Asset damage (L) is ca. 2k. US\$ L=S1; Most severe risk is people risk (S=S2).	S	1. TIT-10154-TAH to Trip 20-C-1002 by operator 2. TIT-10155-TAHH to Trip 20-C-1002 (UCP ESD) 3. FT-10151-FAL to Trip 20-C-1002 by operator (only 1 alarm is counting for a risk reduction)	2	3	SIL 1	1. TIT-10155-TAHH to Trip 20-C-1002 (UCP ESD) <i>SIL 1 SIF in SIS</i> 2. FT-10151-FAL to Trip 20-C-1002 by operator.	2	No action		
02.1.2.2	Flow	No / Not	No/Less Flow	No Cooling Water by fail closed of XV-10152	Overheating of cooling water in intercooler 20-AEC-1002-1. Exceeding of the design temperature of the tubes inside the intercooler (95 deg C). Maximum temperatures of the cooling water (140 deg C -equal to uncooled nitrogen- can be reached. Boiling of water may start at ca. 120 deg C. Tube rupture is possible. Nitrogen induced into the cooling water and exceeding also the design pressure of the cooling water system. Loss of containment is possible. Maximum release with full rupture- 0.2 kg/s (707 kg/h /). Full rupture is not expected. Open area, 4 sides open. Remote suffocation risk to people is possible (safety distance is ca. 1-2 meters. Severity S=S2 (S2 is equal to C A according risk matrix) Asset damage (L) is ca. 10 k. US\$ L=S1; Most severe risk is people risk, S=S2.	S	1. TIT-10154-TAH to Trip 20-C-1002 by operator 2. TIT-10155-TAHH to Trip 20-C-1002 (UCP ESD) 3. FT-10151-FAL to Trip 20-C-1002 by operator (only 1 alarm is counting for a risk reduction) 4. PSV-10153 @3.5 barg to ground	2	3	SIL 1	1. TIT-10155-TAHH to Trip 20-C-1002 (UCP ESD) <i>SIL 1 SIF in SIS</i> 2. FT-10151-FAL to Trip 20-C-1002 by operator (only 1 alarm is counting for a risk reduction) 3. PSV-10153 @3.5 barg to ground (RRF=100)	4	No action		
02.1.2.3	Flow	No / Not	No/Less Flow	No Cooling Water by fail closed of XV-10152	No Cooling of nitrogen in Aftercooler 20-AEC-1002-2. Not exceeding of the design temperature (210 deg C) in the discharge of the 2nd stage of the compressor (may go up 204 deg C.) No loss of containment. The flow over the recycle line is limited during normal operation <10-20%; temperature at the inlet of the 1st stage of the compressor keeps below the design temperature of the inlet pulse damper (80 deg C). No hazardous consequence.		1. TIT-10155-TAHH to Trip 20-C-1002 (UCP ESD) 2. FT-10151-FAL to Trip 20-C-1002 by operator (only 1 alarm is counting for a risk reduction)				1. TIT-10154-TAH to Trip 20-C-1002 by operator 2. TIT-10155-TAHH to Trip 20-C-1002 (UCP ESD) 3. FT-10151-FAL to Trip 20-C-1002 by operator (only 1 alarm is counting for a risk reduction)				
02.1.2.4	Flow	No / Not	No/Less Flow	No Cooling Water by fail closed of XV-10152	Overheating of cooling water in aftercooler 20-AEC-1002-2. Exceeding of the design temperature of the tubes inside the intercooler (95 deg C). Maximum temperatures of the cooling water (140 deg C -equal to uncooled nitrogen- can be reached. Boiling of water may start at ca. 120 deg C. Tube rupture is possible. Nitrogen induced into the cooling water and exceeding also the design pressure of the cooling water system. Loss of containment is possible. Maximum release with full rupture- 0.2 kg/s (707 kg/h /). Full rupture is not expected. No suffocation of people is expected (open area, 4 sides open). Remote suffocation risk to people is possible (safety distance is ca. 1-2 meters. Severity S=S2 (S2 is equal to C A according risk matrix) Asset damage (L) is ca. 10 k. US\$ L=S1; Most severe risk is people risk (S=S2).	S	1. TIT-10155-TAHH to Trip 20-C-1002 (UCP ESD) 2. FT-10151-FAL to Trip 20-C-1002 by operator (only 1 alarm is counting for a risk reduction) 3. PSV-10153 @3.5 barg to ground	2	3	SIL 1	1. TIT-10155-TAHH to Trip 20-C-1002 (UCP ESD) <i>SIL 1 SIF in SIS</i> 2. FT-10151-FAL to Trip 20-C-1002 by operator (only 1 alarm is counting for a risk reduction) 3. PSV-10153 @3.5 barg to ground (RRF=100)	4	No action		

02.15.1.1			Contamination	Tube Rupture in intercooler 20-AEC-1002-1.	See no flow scenarios node 02															
02.15.2.1			Contamination	Tube Rupture in aftercooler 20-AEC-1002-2.	See no flow scenarios node 02															
#N/A																				
#N/A																				

END OF HAZOP WORKSHEET: Cooling Water N2 Compressor

HAZOP WORKSHEET- Instrument Air

Index

Node Index: 03
 Title: Instrument Air
 Drawings: 17811-038-001
 17811-038-002

Node Details: Equipment:
 -20-C-7080 Air Compressor
 -20-DC-7080-1 Pulse Damper inlet
 -20-DC-7080-2 Pulse Damper discharge
 -20-AEC-7080-1 Aftercooler

For consequences of Economics (Asset Damage/Loss) (L); Downtime Loss is not estimated, Only Asset REPAIR costs.
 The following conversion for consequences is followed related to the Risk Matrix in the Hazop Procedure Manual:
 S1= C₁ (minor); S2= C₂ (serious)

Date: 25.04.2022
 Session: Morning
 Attendees: Sjak Rijnaarts
 Kevin Pool
 Jeroen Rust
 Brice Kpozuxu
 Nikan Shahidnia
 Mr. Abedi
 Ms. Techranci
 Mr. Hasemi
 Ms. Khakpur
 Mr. Najmeddin
 Ms. Nazarin Malekinia

Index

INDEX	PARAMETER	GUIDEWORD	DEVIATION	CAUSE	CONSEQUENCE	CAT	SAFEGUARDS	Unmitigated RISK			IPLs	SIL	RECOMMENDATIONS / ACTIONS	ACTION OWNER
								C	F	SIL				
03.1.1.1	Flow	No / Not	No/Less Flow	No Air supply from Plant	1. No Supply to the compressor leading to underpressure at the suction side of the compressor. Worst case is if recycle line is closed. No vacuum is expected, however the discharge pressure will decrease. Increase of temperature of the first stage exceeding the design temperature of the Compressor. Less supply to the end users. Vibrations of the axis of the compressor is possible. No loss of containment. No hazardous consequence. Asset damage (L) < 5000 US\$.	L	1. PIT-71103-PALL to Trip 20-C-7080 (UCP ESD) 1. PIT-71107-PALL to Trip 20-C-7080 (UCP ESD) 3. TIT-71102-TAHH to trip 20-C-7080 (UCP ESD)	1	3	SIL 0	1. PIT-71103-PALL to Trip 20-C-7080 (UCP ESD) 1. PIT-71107-PALL to Trip 20-C-7080 (UCP ESD) 3. TIT-71102-TAHH to trip 20-C-7080 (UCP ESD)	3	No action	
03.1.2.1	Flow	No / Not	No/Less Flow	Blocked Filter in supply line (inlet)	1. No Supply to the compressor leading to underpressure at the suction side of the compressor. Worst case is if recycle line is closed. No vacuum is expected, however the discharge pressure will decrease. Increase of temperature of the first stage exceeding the design temperature of the Compressor. Less supply to the end users. Vibrations of the axis of the compressor is possible. No loss of containment. No hazardous consequence. Asset damage (L) < 5000 US\$.	L	1. PIT-71103-PALL to Trip 20-C-7080 (UCP ESD) 1. PIT-71107-PALL to Trip 20-C-7080 (UCP ESD) 3. TIT-71102-TAHH to trip 20-C-7080 (UCP ESD)	1	3	SIL 0	1. PIT-71103-PALL to Trip 20-C-7080 (UCP ESD) 1. PIT-71107-PALL to Trip 20-C-7080 (UCP ESD) 3. TIT-71102-TAHH to trip 20-C-7080 (UCP ESD)	3	No action	
03.1.3.1	Flow	No / Not	No/Less Flow	Motor or V-belt Drive Failure Compressor 20-C-7080-M	1. No Supply to the end user. Discharge pressure of the Compressor will decrease. No supply to the end users. No hazardous consequence. No asset consequences		1. PIT-71107-PALL to Trip 20-C-7080 (UCP ESD) 2. PIT-71154-PALL to Trip 20-C-7080 (UCP ESD) (lube oil pressure low will stop the compressor)							
03.1.4.1	Flow	No / Not	No/Less Flow	Mechanical Failure Compressor 20-C-7080	1. Worst case is piston failure. No Supply to the end user. Loss of containment is possible. Maximum release < 0.015 kgh (55 kgh/h) open. Compressor may catch fire, damage of compressor. Hurting people is possible. Severity S=S2; S2 is equal to C.A. Asset damage (L) is ca. 25 k. US\$ L=S1; Most severe is people risk. Note: Regular maintenance will reduce this risk.	S	1. PIT-71107-PALL to Trip 20-C-7080 (UCP ESD) 2. PIT-71101-VAHH to Trip 20-C-7080 (UCP ESD)	2	3	SIL 1	1. PIT-71107-PALL to Trip 20-C-7080 (UCP ESD) 2. PIT-71101-VAHH to Trip 20-C-7080 (UCP ESD) SIL 1 SIF in SIS	2	No action	
03.1.5.1	Flow	No / Not	No/Less Flow	Partial Blockage of shell of the aftercooler 20-AEC-7080-1 Gas side (Gas is going through the shell)	1. Increased pressure drop over the aftercooler and increase of temperature in the outlet of the aftercooler and in the discharge of the compressor. Exceeding of the design temperature in the discharge of the compressor (upstream aftercooler). No loss of containment. No hazardous consequence. Asset damage (L) Compressor < 5000 US\$. IEF=0.01. Downstream is possibly consequences for high temperature.	L	1. PIT-71107-PAHH to trip 20-C-7080 (UCP ESD). 2. PSV-71101 @ 26 bara 3. TIT-71102-TAHH to trip 20-C-7080 (UCP ESD)	1	2	No action			No action	1. Ensure that high temperature discharge from the air compressor is evaluated in the Hazop of the Plant. Maximum temperature downstream should be safeguarded on 95 deg. C (based on setting of the PSV-71101).
03.1.6.1	Flow	No / Not	No/Less Flow	Blocked flow by check valves at outlet fails closed, also in case of lower pressure downstream.	1. No supply to the end user. Increased pressure and temperature in the discharge of the compressor. Flow will be recycled to the inlet. Recycle line will be designed for full flow. No consequences.		1. PIT-71107-PAHH to trip 20-C-7080 (UCP ESD). 2. PSV-71101 @ 26 bara 3. TIT-71102-TAHH to trip 20-C-7080 (UCP ESD)							
03.1.7.1	Flow	No / Not	No/Less Flow	Blocked flow downstream (no take off)	1. No supply to the end user. Increased pressure and temperature in the second stage of the compressor. Flow will be recycled to the inlet. Recycle line will be designed for full flow. No consequences.		1. PIT-71107-PAHH to trip 20-C-7080 (UCP ESD). 2. PSV-71101 @ 26 bara 3. TIT-71102-TAHH to trip 20-C-7080 (UCP ESD)							
03.1.8.1	Flow	No / Not	No/Less Flow	Less/No flow over recycle line by 'Fail Closed AFC PV-71101 or control failure to closed valve in case AFC should be NOT fully closed.	1. Increased pressure and temperature in the second stage of the compressor. Exceeding of the design temperature in the discharge of the compressor. No loss of containment. No hazardous consequence. Asset damage (L) < 5000 US\$. IEF=0.1	L	1. PIT-71107-PAHH to trip 20-C-7080 (UCP ESD). 2. PSV-71101 @ 26 bara 3. TIT-71102-TAHH to trip 20-C-7080 (UCP ESD)	1	2	No action			No action	
03.1.9.1	Flow	No / Not	No/Less Flow	No lube oil flow by filter blockage or Pump failure to compressor	1. Overheating of the bearings in case of long term reduced flow. Asset damage (L) of the bearings of the compressor. < 5000 US\$. IEF=0.1	L	1. PIT-71104-PALL to trip 20-C-1002 (UCP ESD)	1	3	SIL 0	1. PIT-10154-PALL to trip 20-C-1002 (UCP ESD)	1	No action	
03.2.1.1	Flow	More	More/High Flow	More flow over the recycle line by 'Fail Opened AFC PV-71101 or control failure to opened valve in case AFC should be NOT fully opened.	1. Decreased pressure and temperature in the second stage of the compressor. Less supply to the plant/ end user. No hazardous consequence; No asset consequence.		1. PIT-71107-PALL to trip 20-C-7080 (UCP ESD)							
03.4.1.1	Pressure	More	High Pressure	No additional scenarios identified.	See also no flow scenarios									
03.5.1.1	Pressure	Less	Low Pressure	No additional scenarios identified.	See also no flow scenarios									
03.6.1.1	Temperature	More	High Temperature	High Lube oil Temperature during stop compressor by control failure oil heater .	Increased temperature of the lube oil, however not exceeding the ignition temperature/flash point of the lube oil, also not exceeding the design temperature of sump or lube oil system. Less lubrication during the start because of lower viscosity. Pressure in the lube oil system will also decrease. No overheating of the heater, because it is a submerged system. No hazardous consequences, no asset consequences.		1. PIT-71104 to trip 20-C-7080 (UCP ESD), no successful safeguard because the heater is only operating during compressor stop. 2. Heater is self limiting with higher temperature.							
03.6.2.1	Temperature	More	High Temperature	No additional scenarios identified.	See also no flow scenarios and no flow scenarios node 04									
03.7.1.1	Temperature	Less	Low Temperature	Low Lube oil Temperature at start by failure oil heater or control failure oil heater .	No consequences, because compressor is designed for lube oil at ambient conditions									
03.8.1.1	Level	More	High Level	Not applicable in this node.										
03.9.1.1	Level	Less	Low Level	Not applicable in this node.										
03.10.1.1	Utilities	No / Not	Utilities Failure	No additional scenarios identified.	At power failure all valves will go to the safe position.									
03.15.1.1			Contamination											
#N/A														
#N/A														
#N/A														
#N/A														
#N/A														

04.1.2.3	Flow	No / Not	No/Less Flow	No Cooling Water by fail closed of XV-10152	No Cooling of Compressor 20-C-7080. Not exceeding of the design temperature (170 deg C for valves, 210 deg C for casing and internal cooling water circuit); temperature in the discharge of the compressor may go up ca. 180 deg C. No loss of containment. No hazardous consequence. No Asset damage (L) is expected.	1. TIT-71102-TAHH to Trip 20-C-7080 (UCP ESD) 2.. FT-71101-FAL to Trip 20-C-7080 (UCP ESD)												
04.1.3.1	Flow	No / Not	No/Less Flow	Less Cooling Water by blockage filter at inlet or failure closed check valve	No Cooling of air in Aftercooler 20-AEC-7080-1. The flow over the recycle line is limited during normal operation <10-20%; temperature at the inlet of the 1st stage of the compressor keeps below the design temperature of the inlet pulse damper (80 deg C). No hazardous consequence.	1. FT-71101-FAL to Trip 20-C-7080 by operator												
04.1.3.2	Flow	No / Not	No/Less Flow	Less Cooling Water by blockage filter at inlet or failure closed check valve	Overheating of cooling water in aftercooler 20-AEC-7080-1. Exceeding of the design temperature of the tubes inside the aftercooler (95 deg C). Maximum temperatures of the cooling water (140 deg C -equal to uncooled air- can be reached. Boiling of water may start at ca. 120 deg C. Tube rupture is possible. air induced into the cooling water and exceeding also the design pressure of the cooling water system. Loss of containment is possible. Maximum release with full rupture< 0.015 kg/s (55 kg/h). Full rupture is not expected. No hazardous consequence. Asset damage (L) is ca. 5 k. US\$ L=S1;	L 1. FT-71101-FAL to Trip 20-C-7080 by operator 2. PSV-71101 @3.5 barg to ground	1	3	SIL 0	1. FT-71101-FAL to Trip 20-C-7080 by operator 2. PSV-71101 @3.5 barg to ground	3	No action						
04.1.3.3	Flow	No / Not	No/Less Flow	Less Cooling Water by blockage filter at inlet or failure closed check valve	No Cooling of Compressor 20-C-7080. Not exceeding of the design temperature (170 deg C for valves, 210 deg C for casing and internal cooling water circuit); temperature in the discharge of the compressor may go up ca. 180 deg C. No loss of containment. No hazardous consequence. No Asset damage (L) is expected.	1. TIT-71102-TAHH to Trip 20-C-7080 (UCP ESD) 2.. FT-71101-FAL to Trip 20-C-7080 (UCP ESD)												
04.2.1.1	Flow	More	More/High Flow	More Cooling Water flow during compressor stop by fail opened of XV-10152	No consequences													
04.4.1.1	Pressure	More	High Pressure	Expansion by warming up when cooling water closed in during compressor stop	Pressure increase in the cooling water system, however no exceeding of the design pressure is expected. No consequences.	1. 'PSV-71102												
04.4.1.1	Pressure	More	High Pressure	No additional scenarios identified.	See also no flow scenarios													
04.5.1.1	Pressure	Less	Low Pressure	No additional scenarios identified.	See also no flow scenarios													
04.6.1.1	Temperature	More	High Temperature	No additional scenarios identified.	See also no flow scenarios and no flow scenarios node 04													
04.7.1.1	Temperature	Less	Low Temperature	Not applicable in this node.														
04.8.1.1	Level	More	High Level	Not applicable in this node.														
04.9.1.1	Level	Less	Low Level	Not applicable in this node.														
04.10.1.1	Utilities	No / Not	Utilities Failure	No additional scenarios identified.														
04.15.1.1			Contamination	Tube Rupture in intercooler 20-AEC-7080-1.	See no flow scenarios node 04													
#N/A																		
#N/A																		

END OF HAZOP WORKSHEET: Cooling Water AIR Compressor



BUREAU
VERITAS

Move Forward with Confidence

Bureau Veritas Riskcontrol The Netherlands B.V.



RISKCONTROL

Client: AIRPACK

BV Project Title: BUPC MEG PLANT HAZOP & SIL study
DD - Compressors

BV Project Reference: 17811-OO-0703

**This workbook is an accurate record of the discussion with the client and does not represent Bureau Veritas opinion on the subject.*

Rev	Date	Person(s) responsible	Subject of the revision
0	26-04-2022	S. Rijnaarts	First Issue



BUREAU
VERITAS

Move Forward with Confidence

Bureau Veritas Riskcontrol The Netherlands B.V.



RISKCONTROL

Client: AIRPACK

BV Project Title: BUPC MEG PLANT HAZOP & SIL study
DD - Compressors

BV Project Reference: 17811-OO-0703

**This workbook is an accurate record of the discussion with the client and does not represent Bureau Veritas opinion on the subject.*

Rev	Date	Person(s) responsible	Subject of the revision
0	26-04-2022	S. Rijnaarts	First Issue



BUREAU
VERITAS

Move Forward with Confidence

Bureau Veritas Riskcontrol The Netherlands B.V.



RISKCONTROL

Client: AIRPACK

BV Project Title: BUPC MEG PLANT HAZOP & SIL study
DD - Compressors

BV Project Reference: 17811-OO-0703

**This workbook is an accurate record of the discussion with the client and does not represent Bureau Veritas opinion on the subject.*

Rev	Date	Person(s) responsible	Subject of the revision
0	26-04-2022	S. Rijnaarts	First Issue



BUREAU
VERITAS

Move Forward with Confidence